

1-1

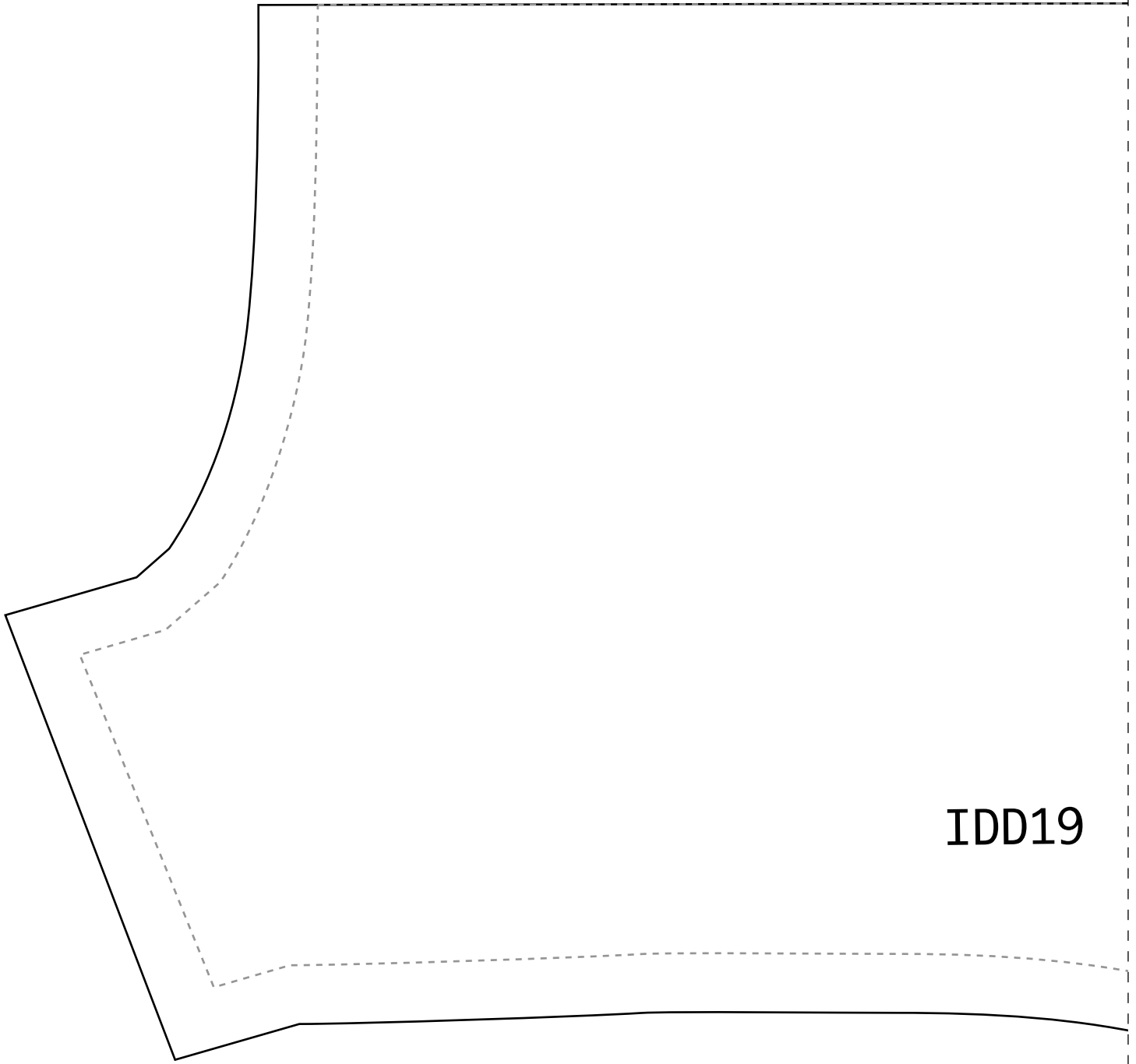

IDD19

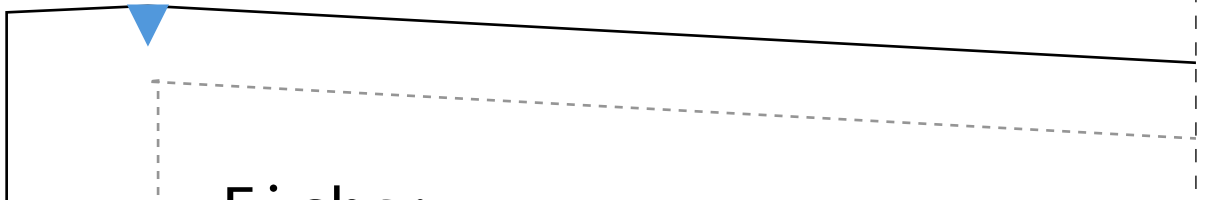

Fischer

## FICHA:

- Tecido plano 1,4m de largu
  - Indicado tecidos fluidos t  
viscose, viscolinho, linho  
chambray, etc
  - Barra com bainha 2cm
  - Decote com viés rebatido n
  - 1,2m para os tamanhos 36-3
  - 1,3m para os tamanhos 40-4
  - 1,4m para os tamanhos 44-4
  - 1,5m para os tamanhos 48-5
  - 1,6m para os tamanhos 52-5
-

dobra

# Instituto Diana Demarc Semana CMC - Agora é S Blusa Manga Bufante

Costas  
1x-36

---

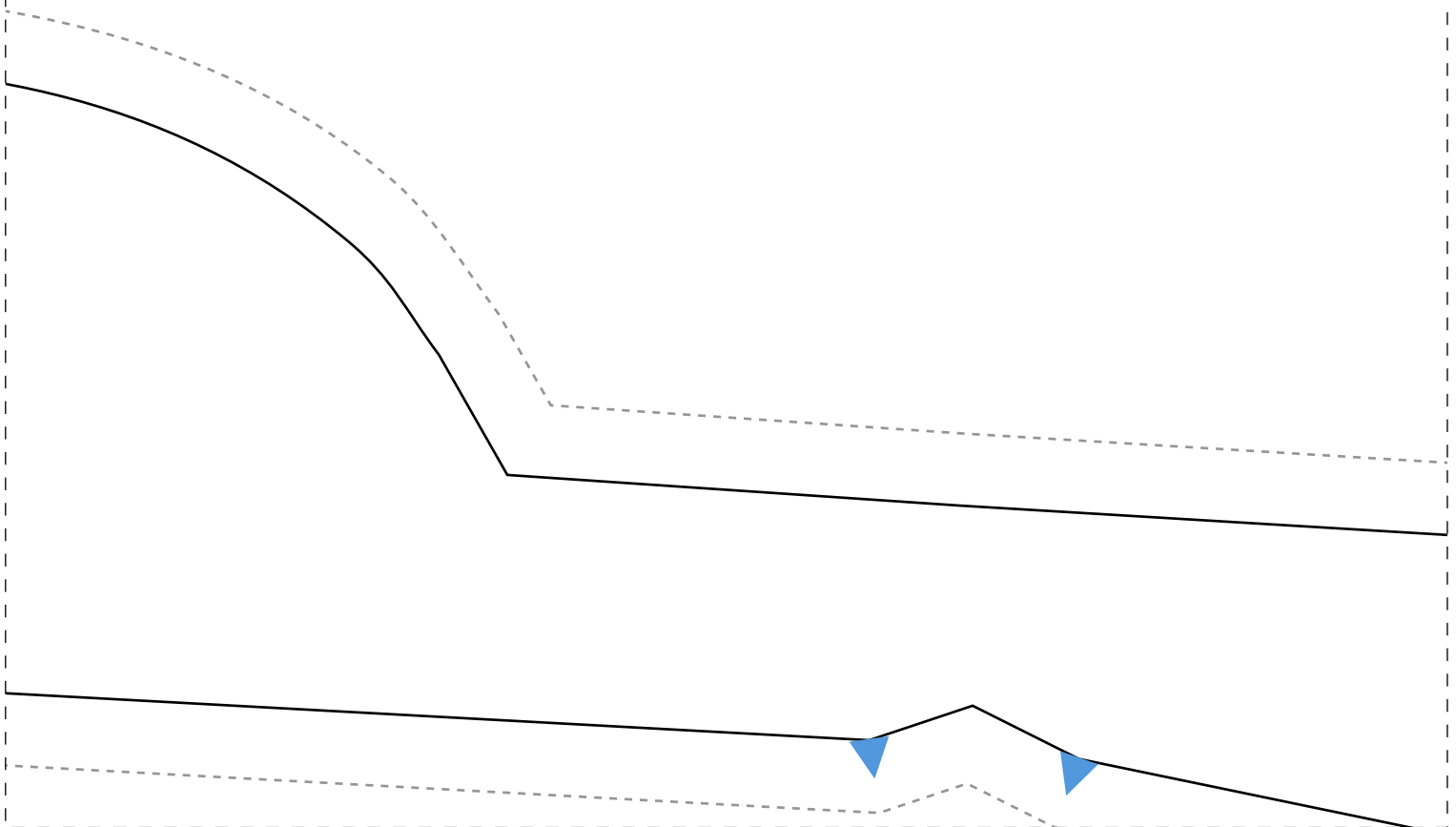

2-2

ra  
ais como  
misto,

a reta

8  
2  
6  
0  
4

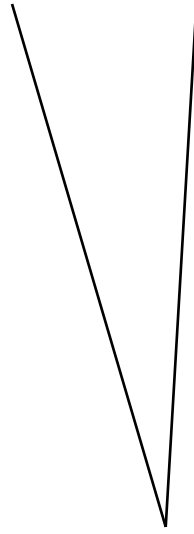

Frente  
1x-36

dobra

hi  
ua Vez

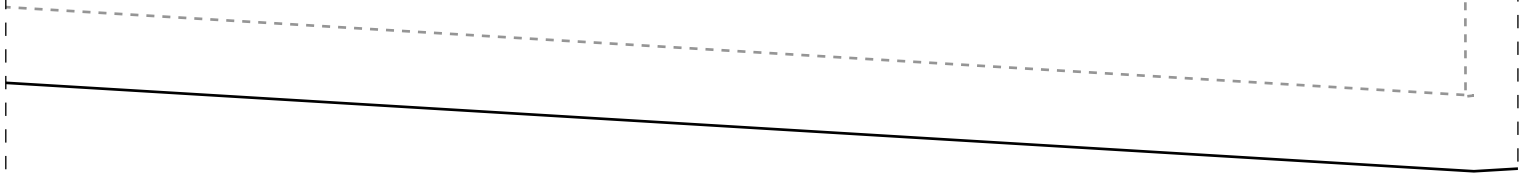

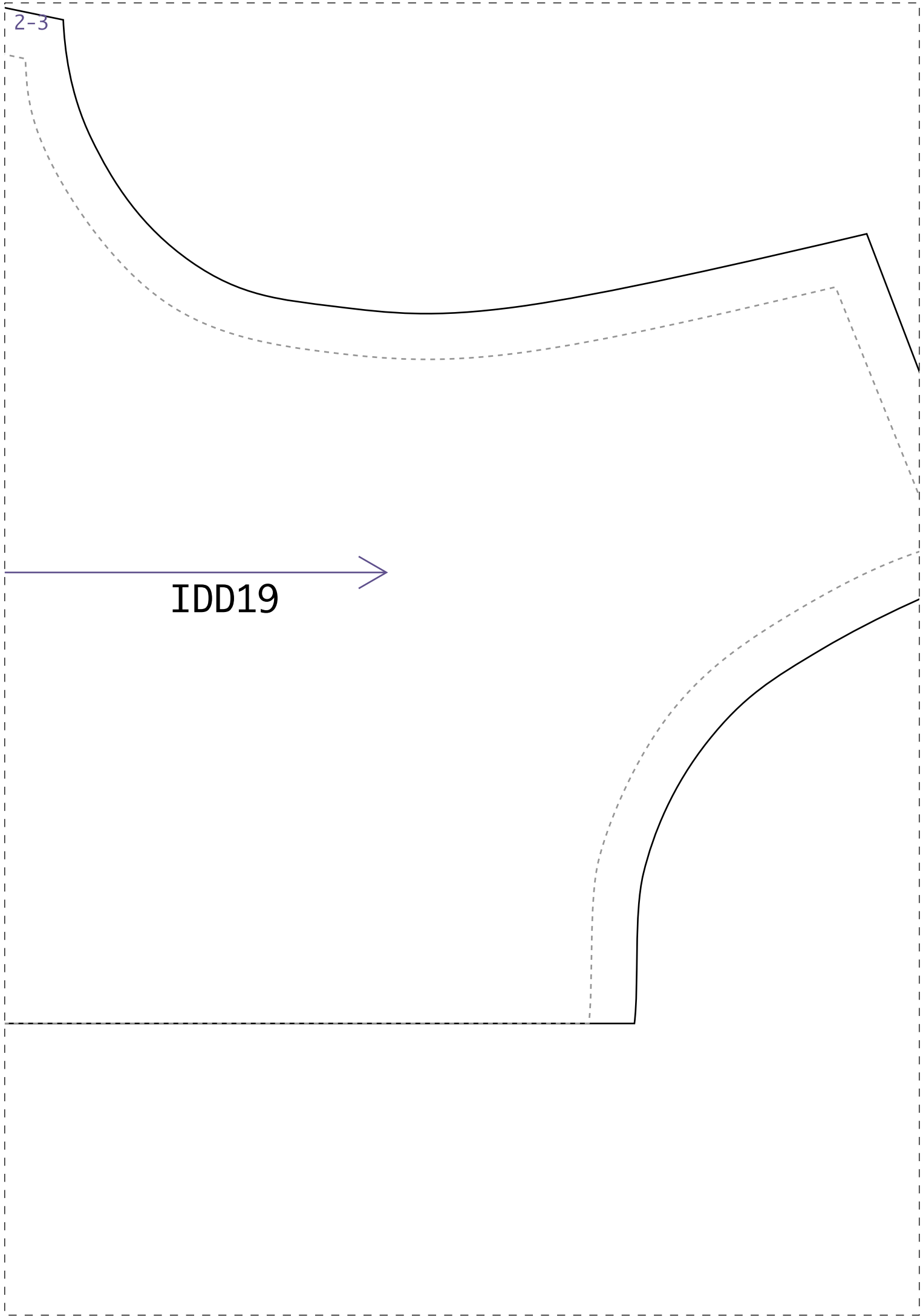

2-3

IDD19

1-4

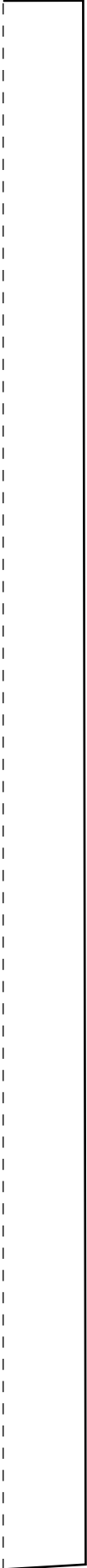

4cm



Institut  
Semana C  
Blusa M

anzir

2-4

f1

IDD19

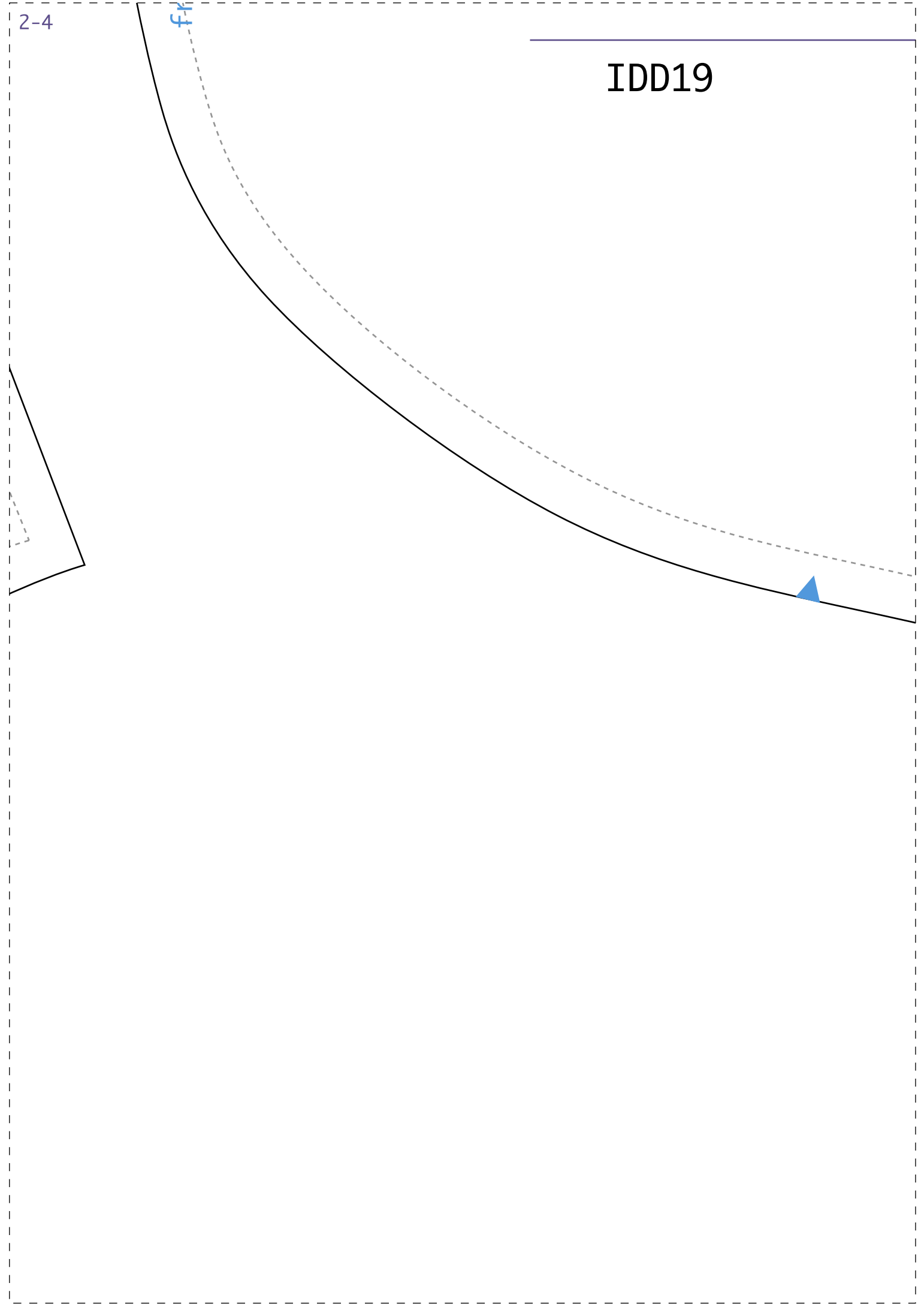



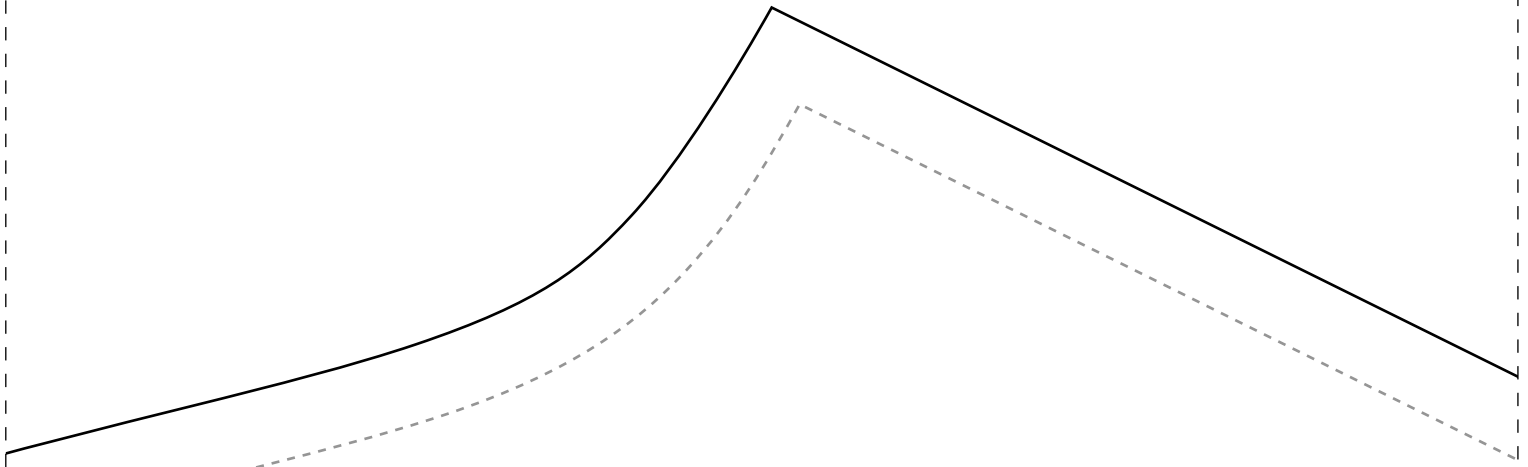

to Diana Demarchi  
CMC - Agora é Sua Vez  
Manga Bufante

2-5

EX 33



frente

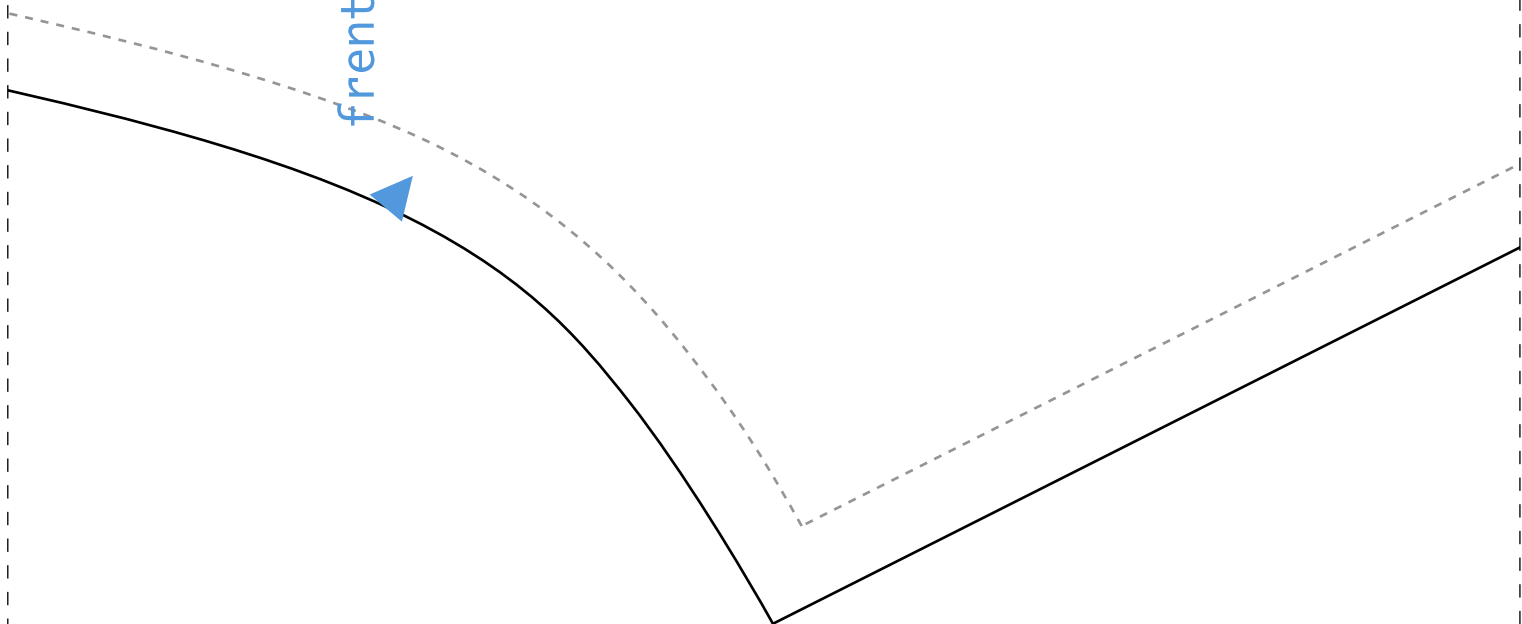

1-6

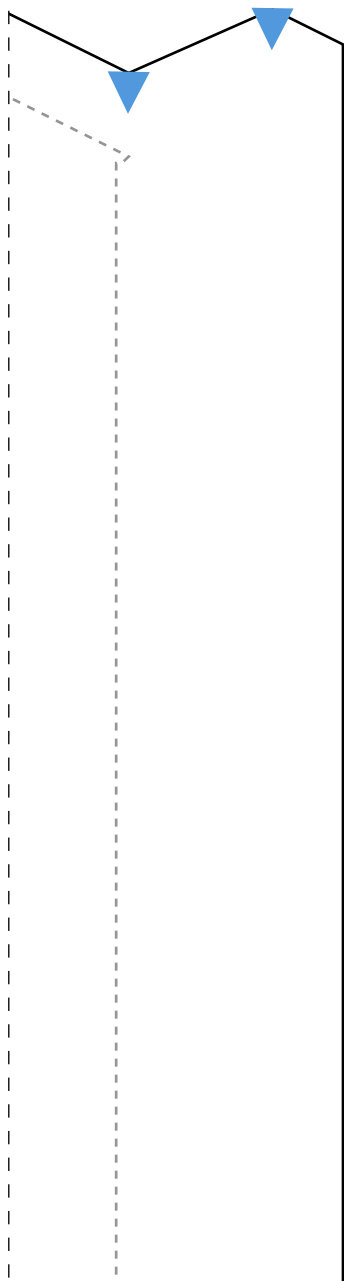

2-6

