

Teste de impressão: ao imprimir seu molde, meça o quadrado que deverá ter a mesma medida informada (4cm), assim você se certificará que ele foi impresso no tamanho correto.

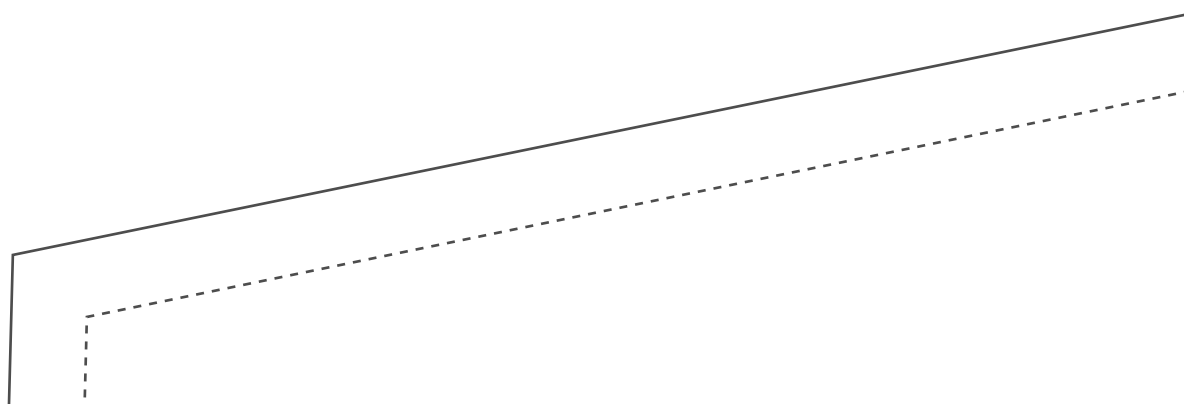

2-1

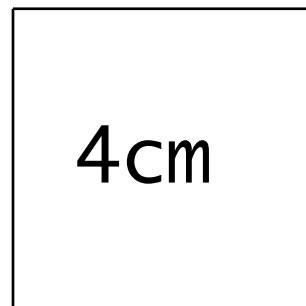

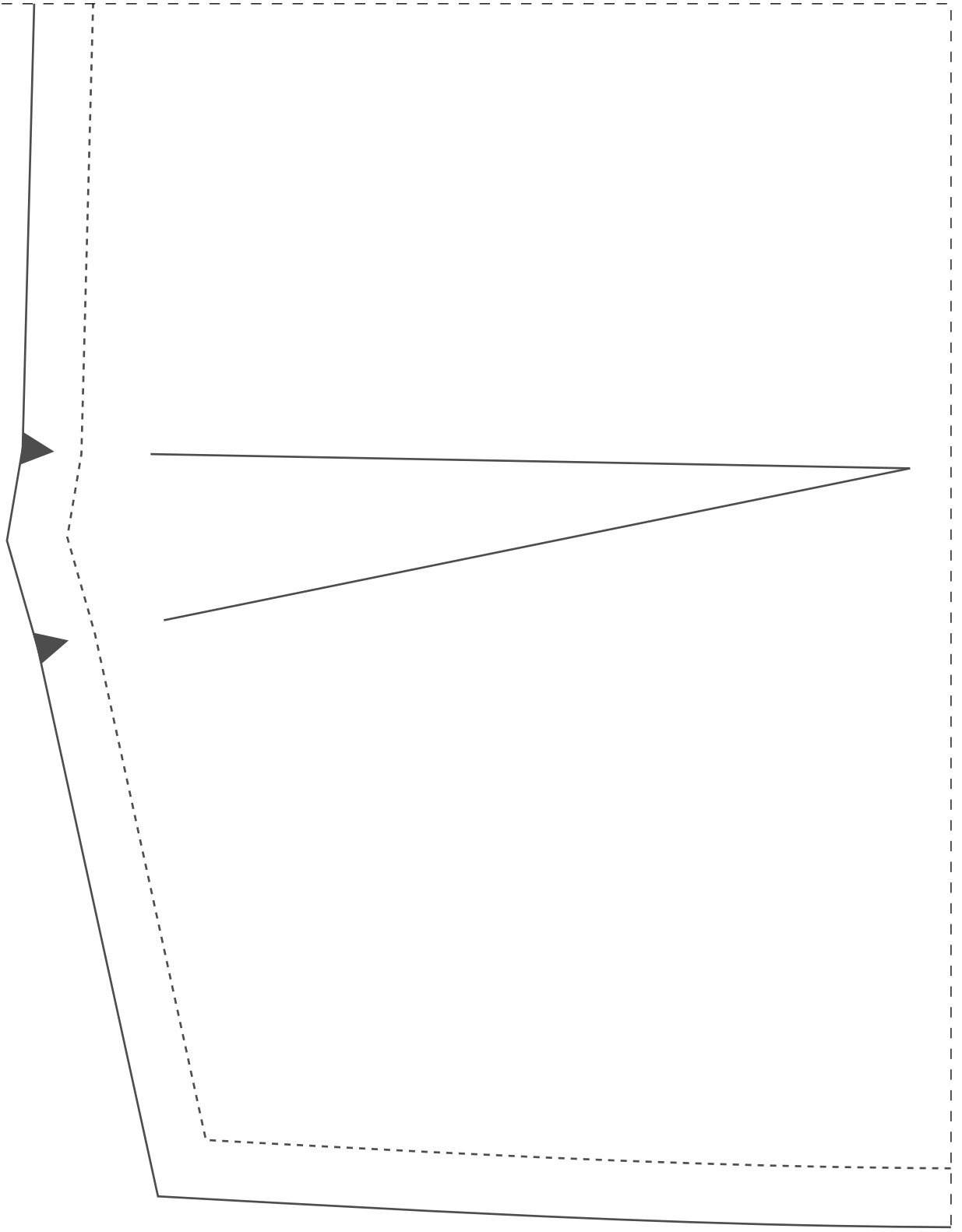
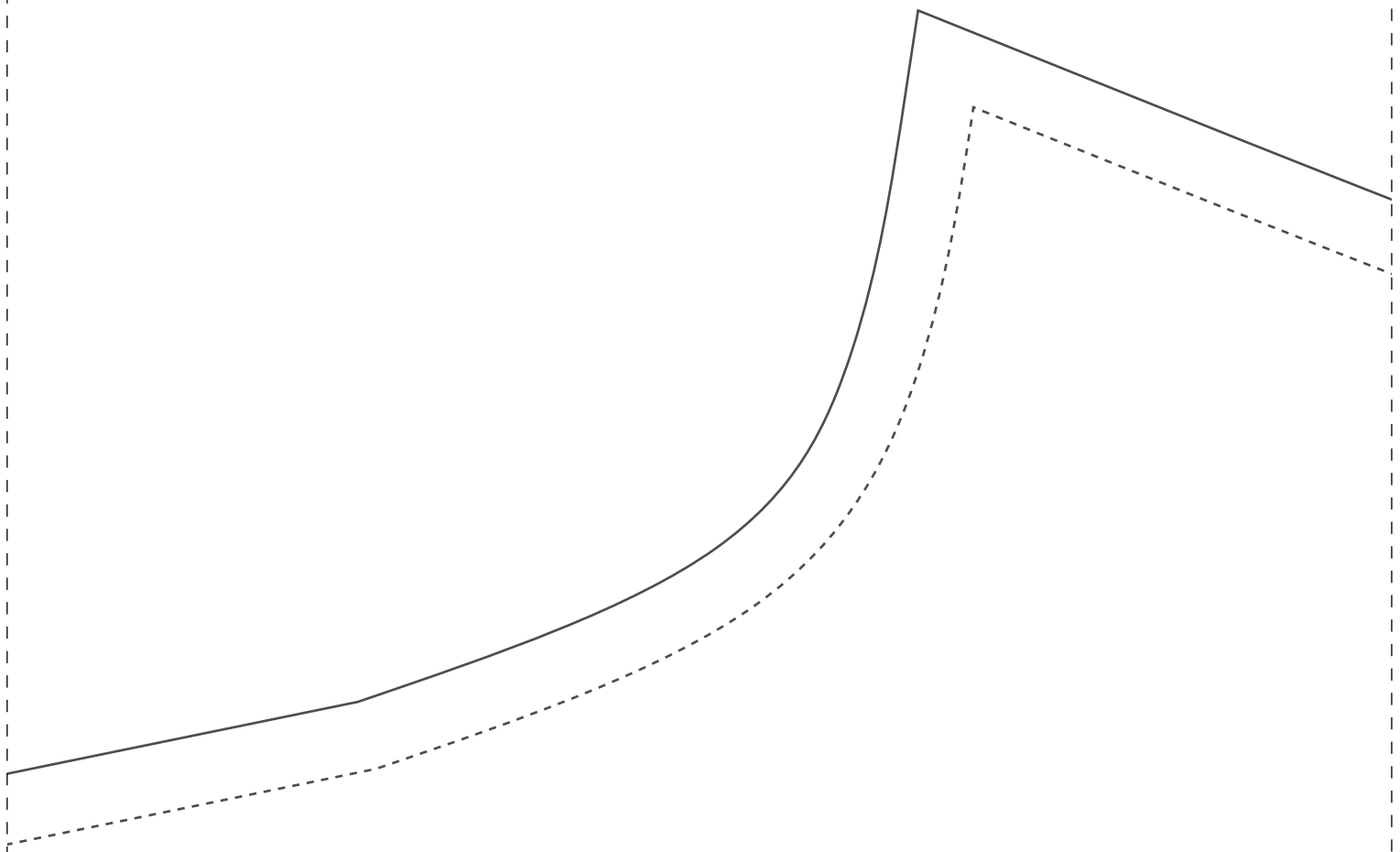

Ficha Técnica
-Tecido Plano
-Linho, gaba
ou similares
-Bolso faca
-Cós entrete
-1,6m para o
-2m para os
-1 zíper com

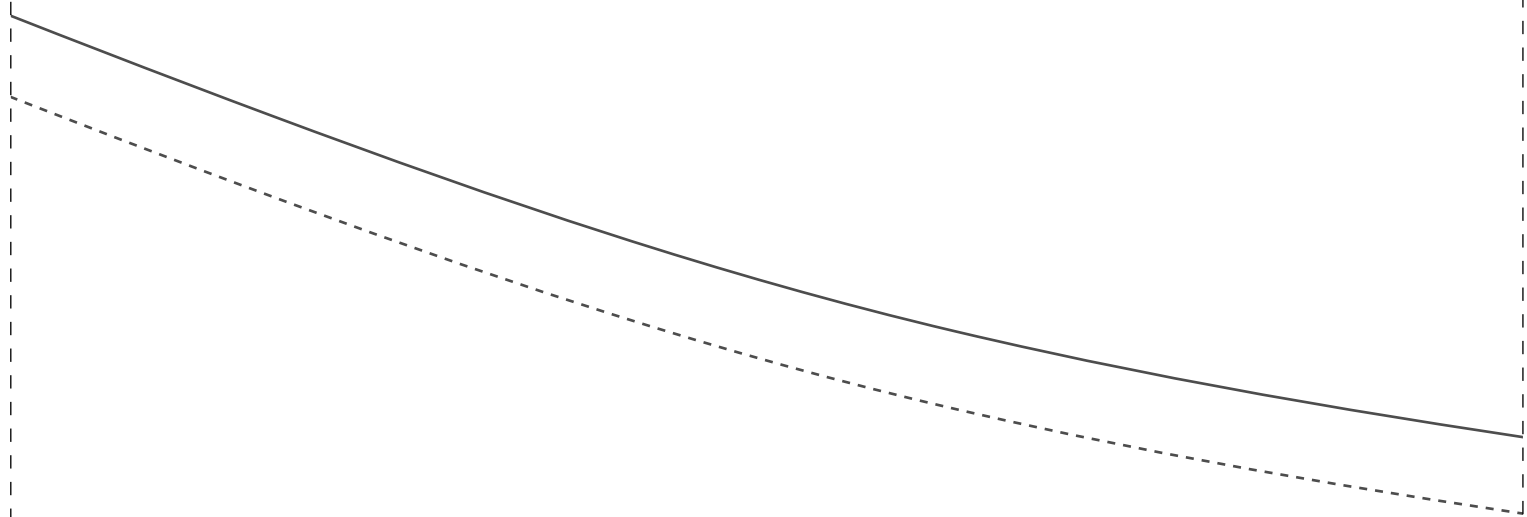

traseiro 2x
36

a:
o 1,4m de largura
rdine, alfaiataria

lado (opcional)
s tamanhos 36 ao 42
tamanhos 44 ao 54
um 15cm

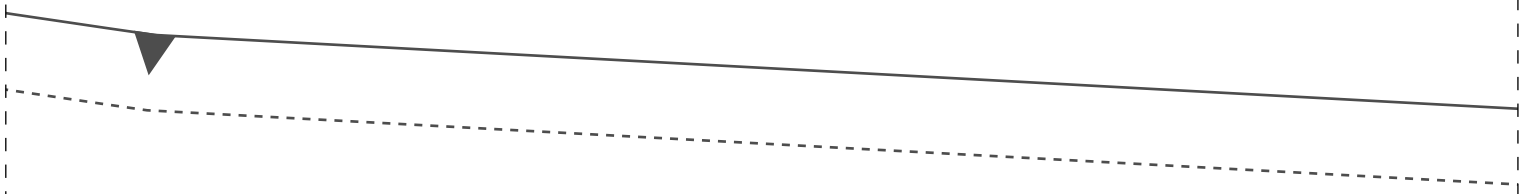

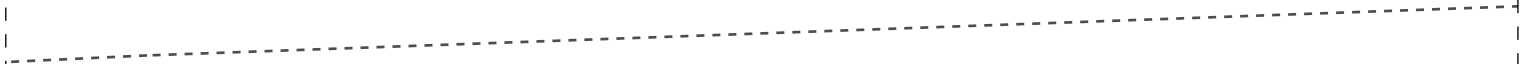

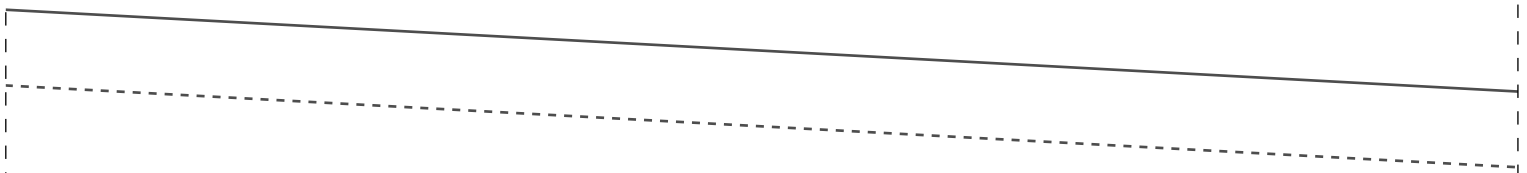



IDDED CD33

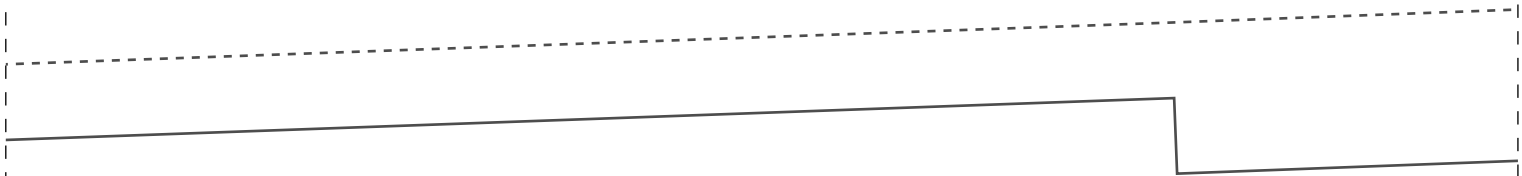

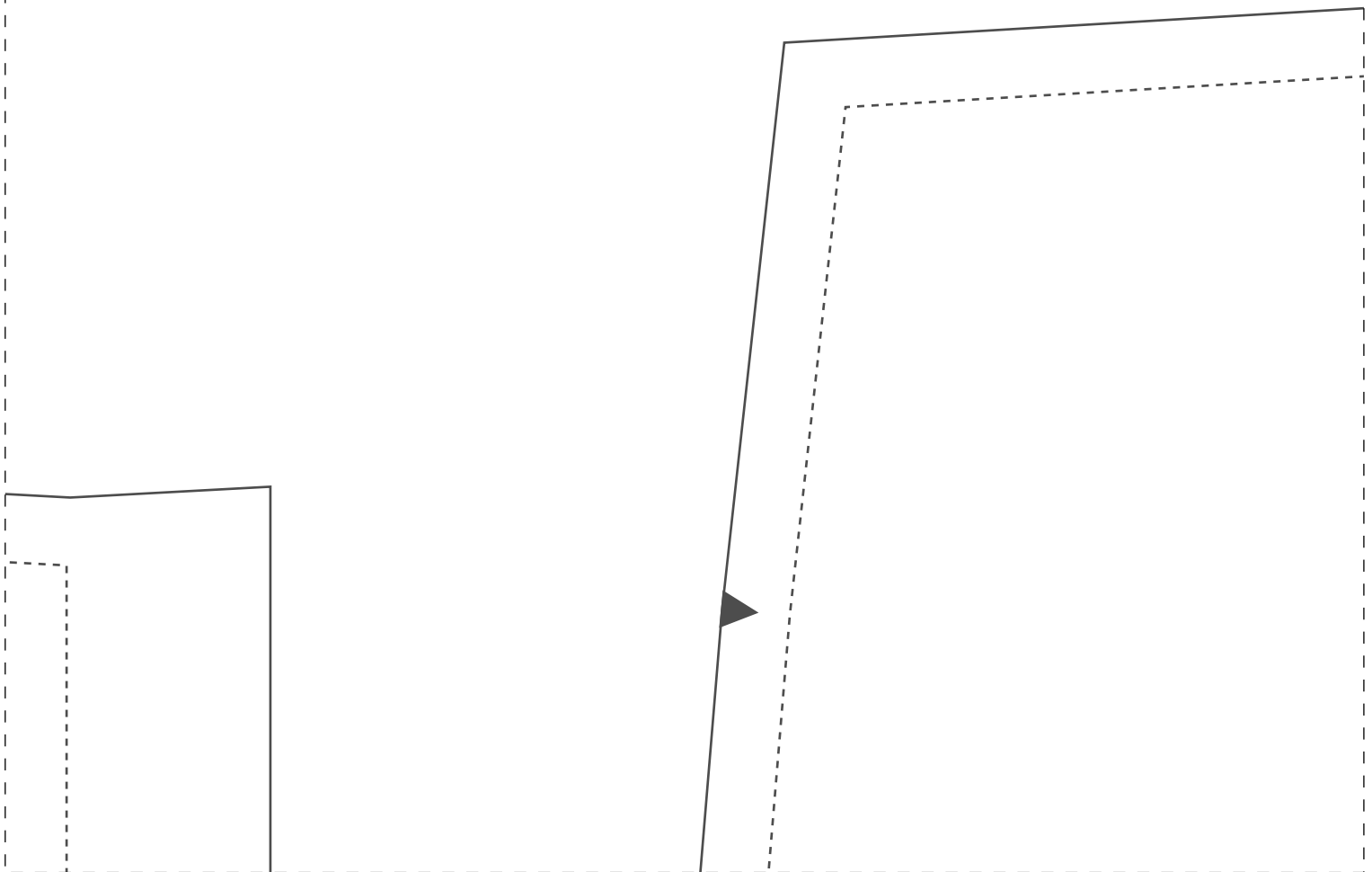

2-6

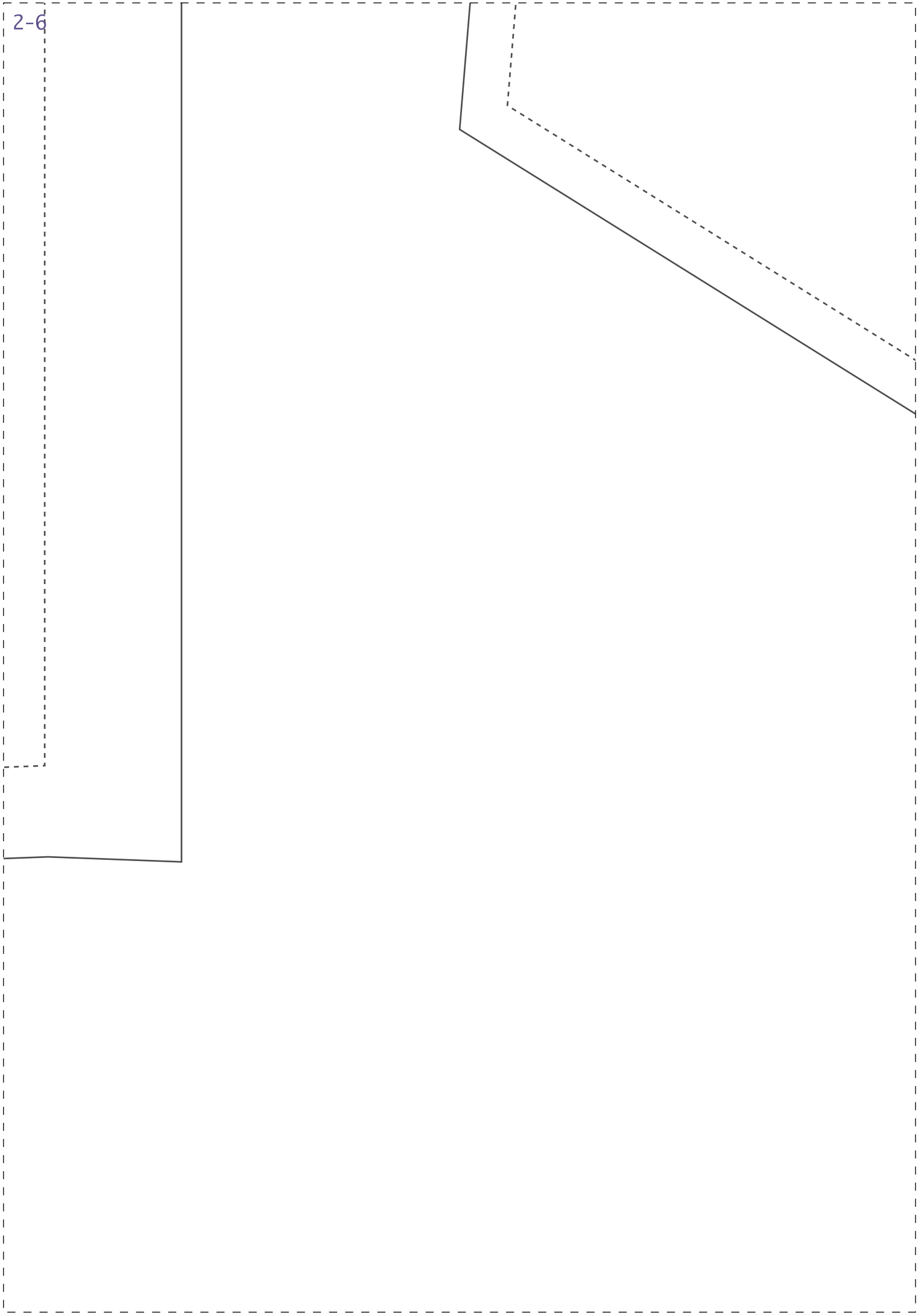

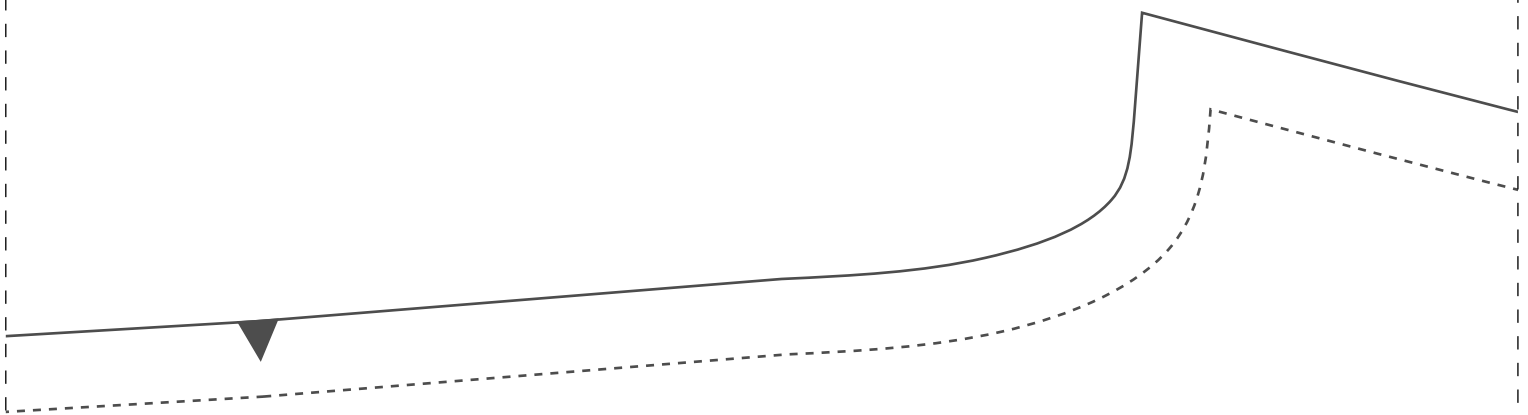

Instituto Diana De
Escola de Costura
IDD Fashion Day
Calça Feminina AL

PROIBIDA REVENDA

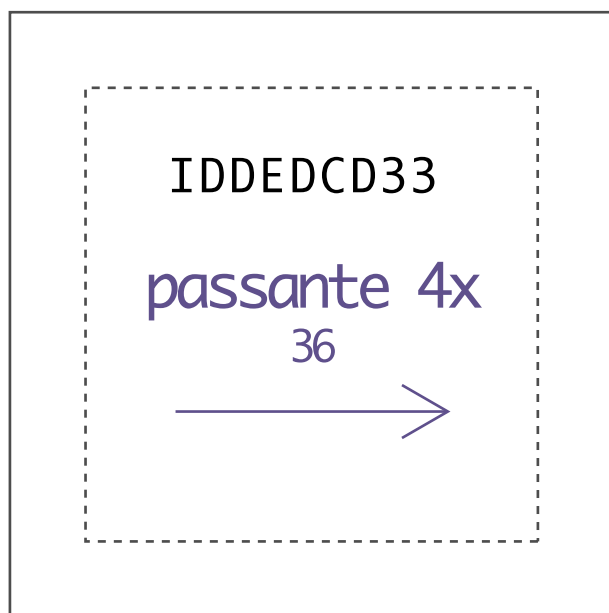
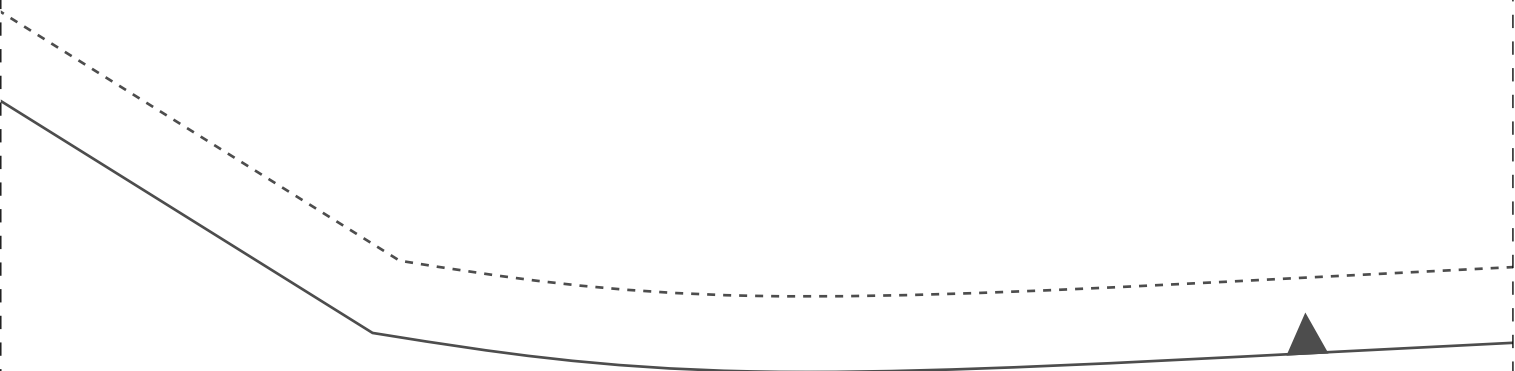

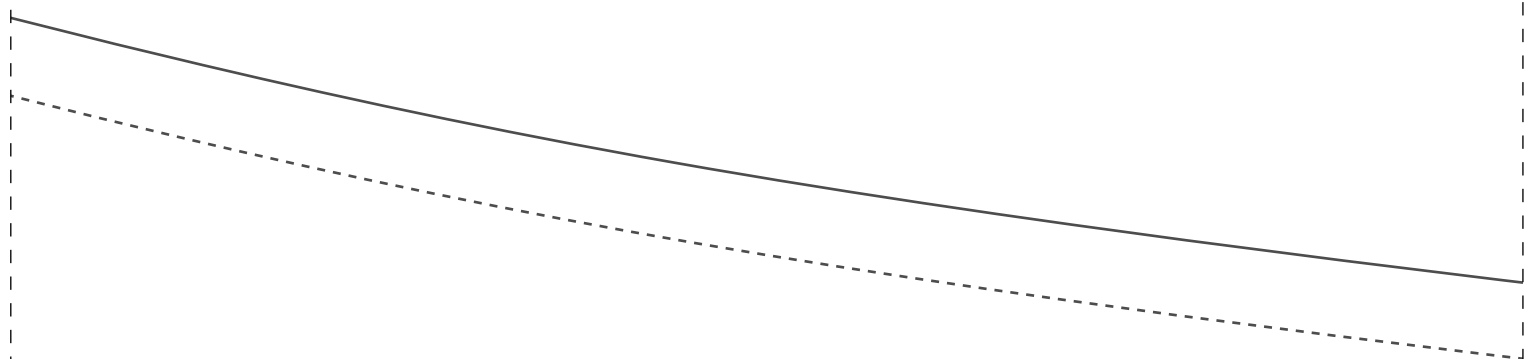

dianteiro 2x

36



emarchi

r

faiataria

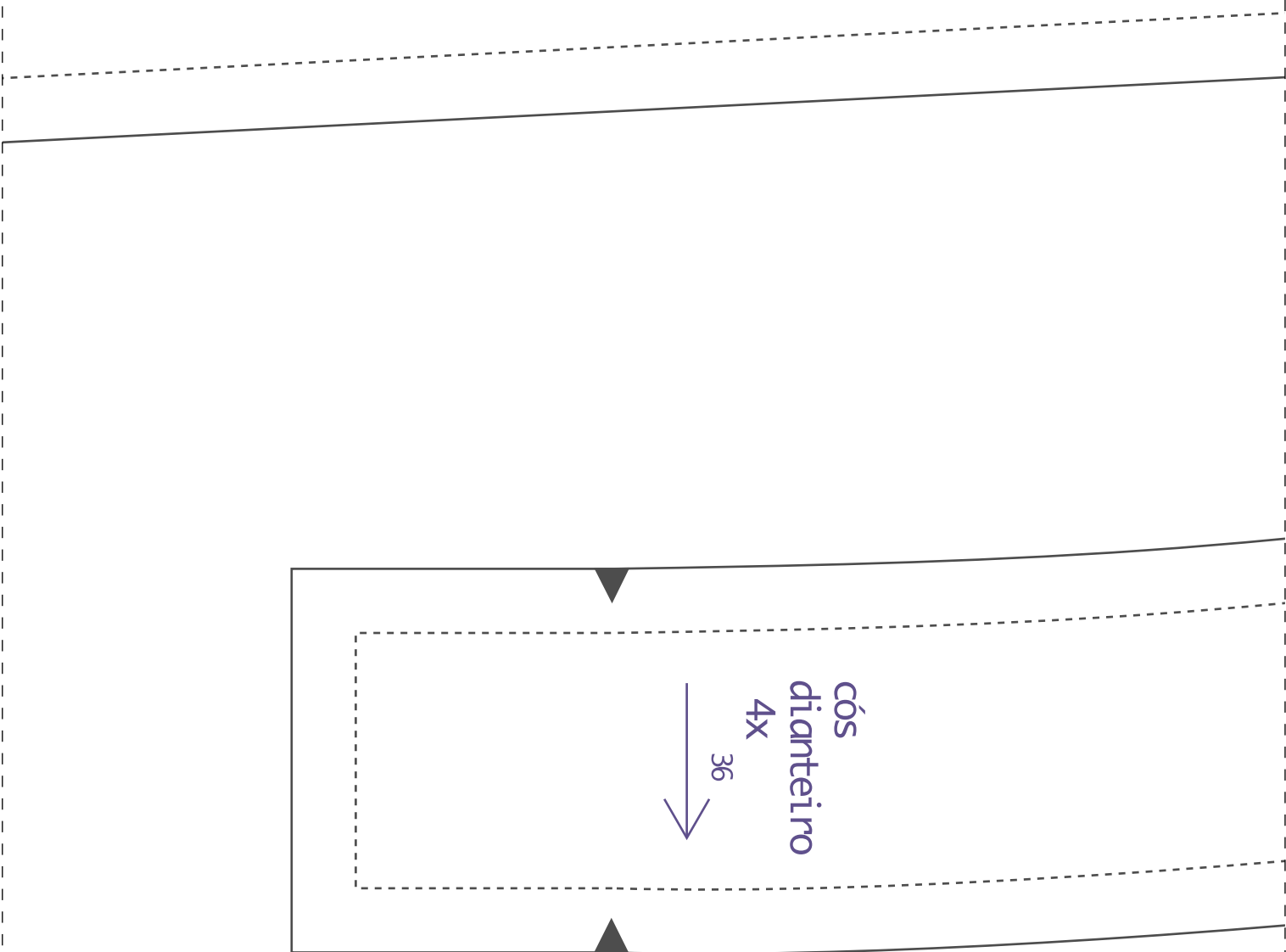

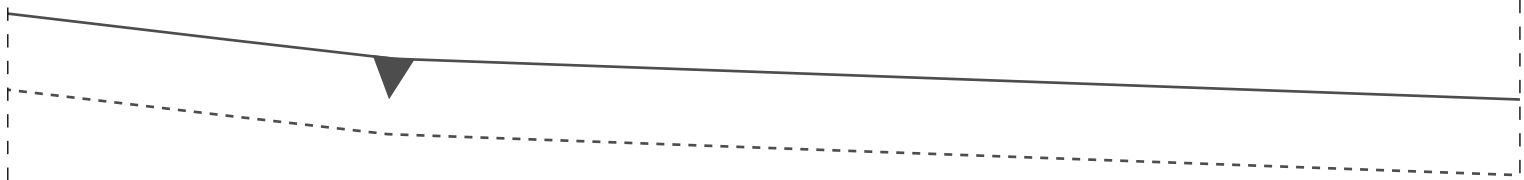

IDDED CD33

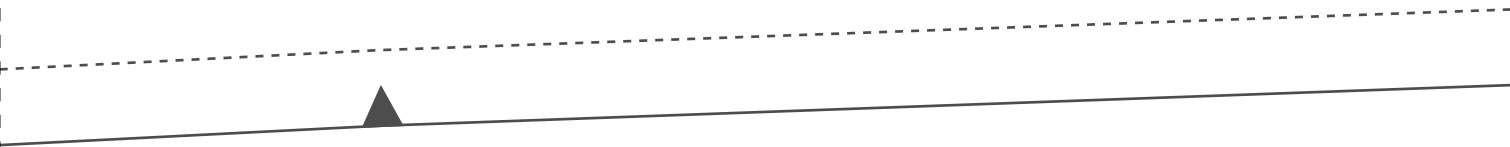

IDDED CD33

1-10

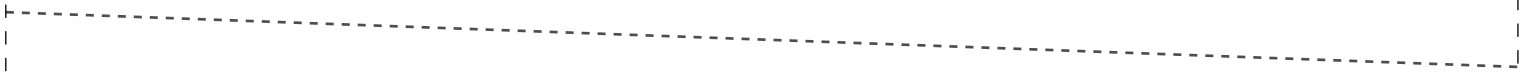

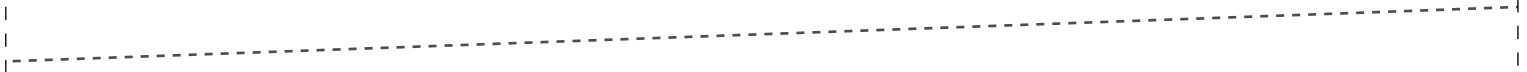

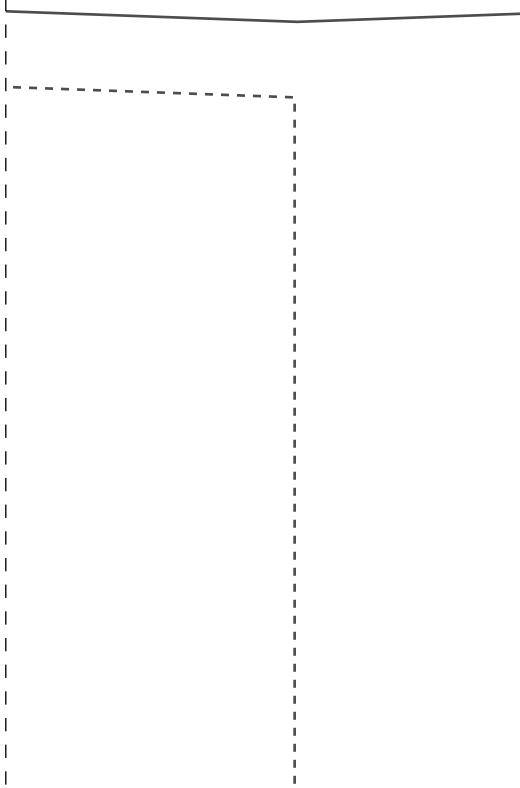
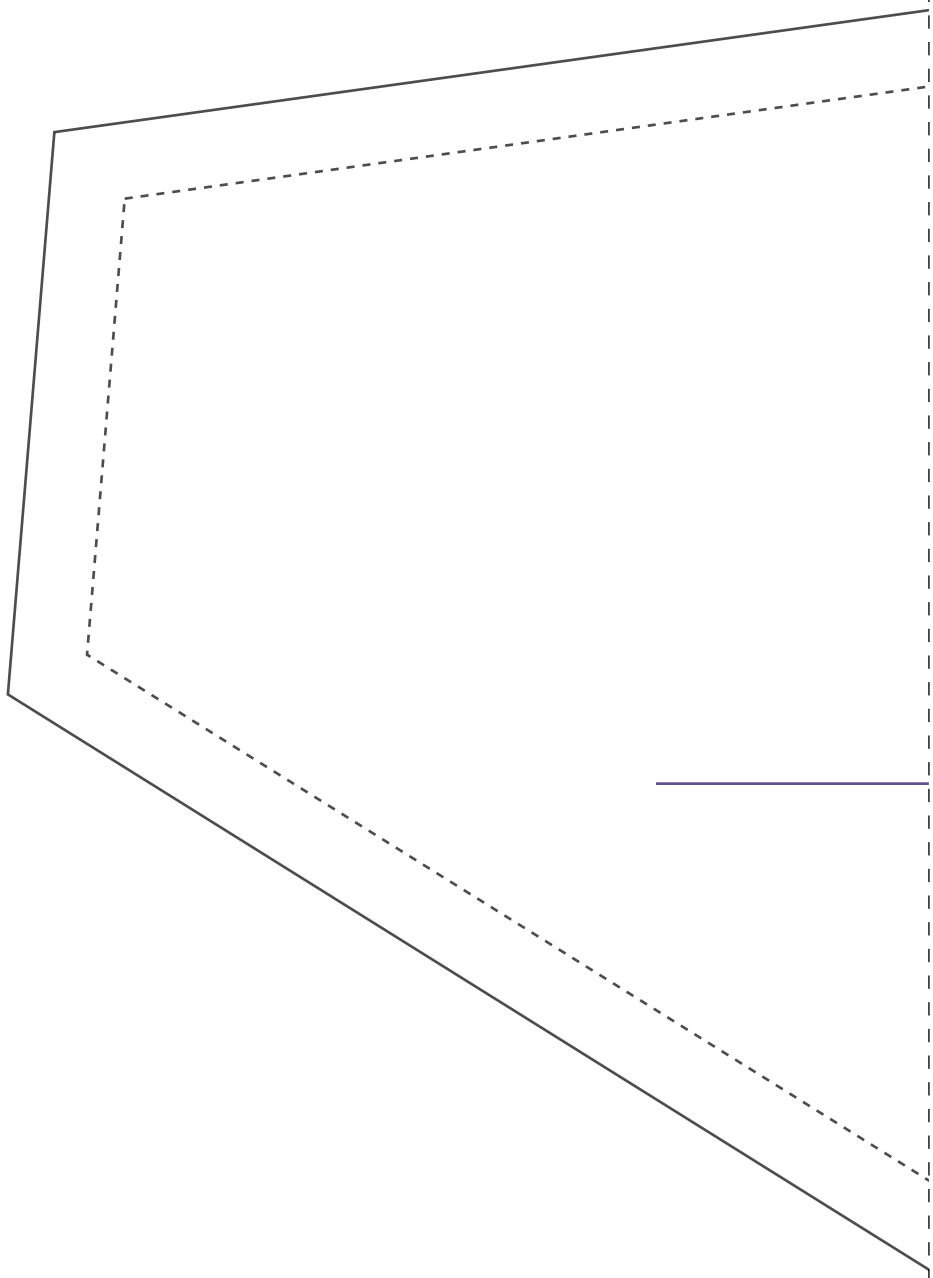

Zíper 15cm

Pertingal 1x₃₆



Dobra

IDDED CD33

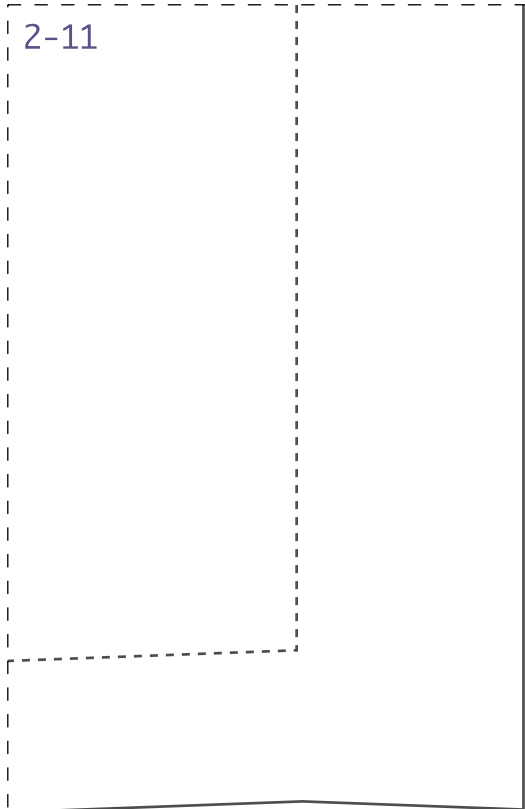

1-12

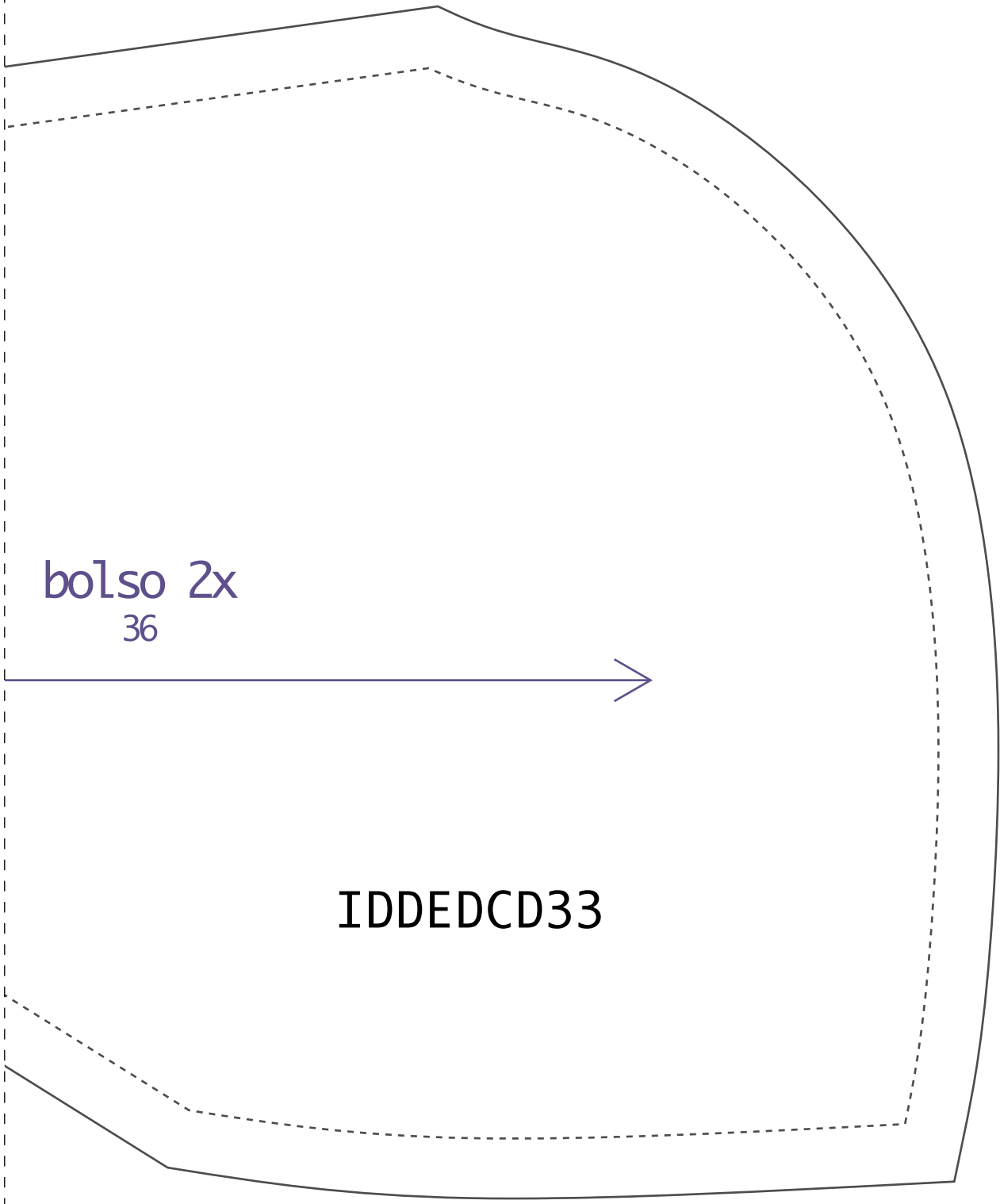

bolso 2x
36



IDDED CD33

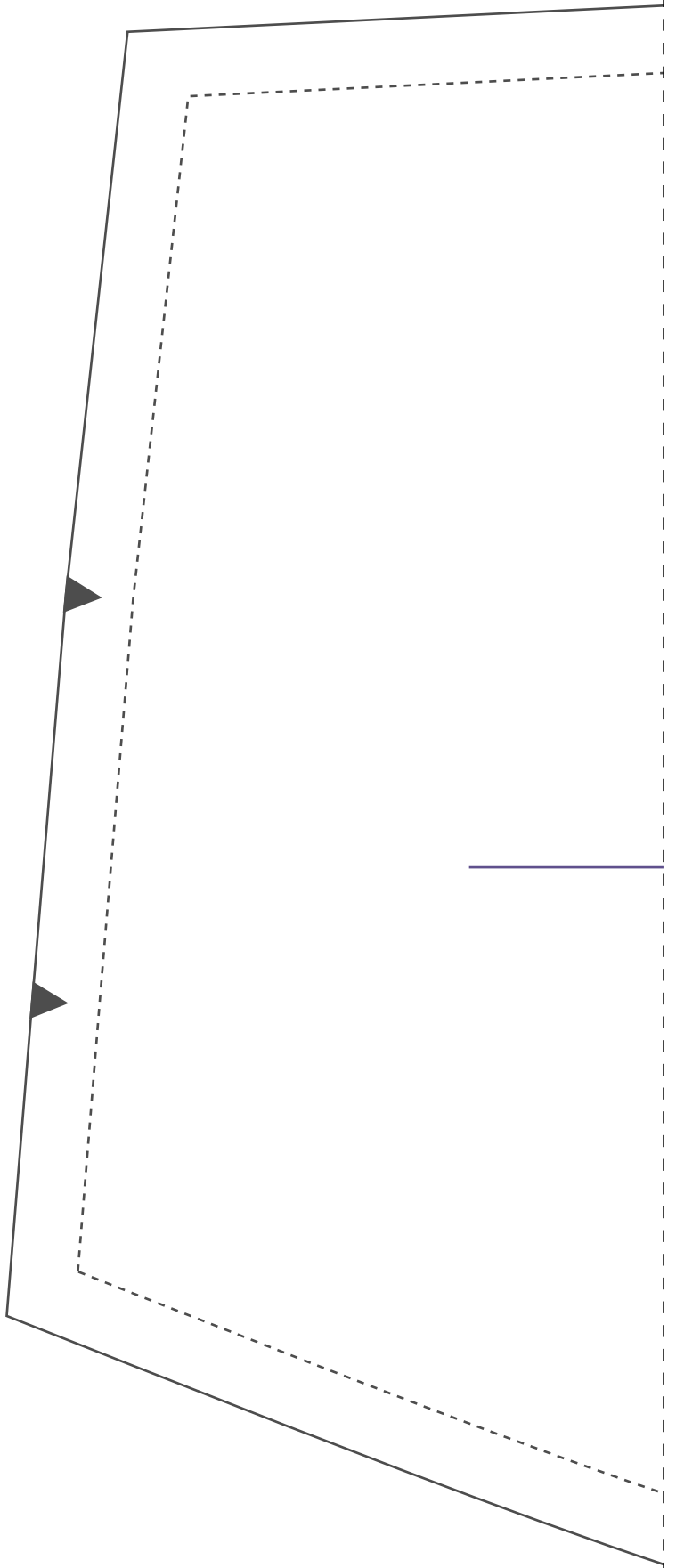

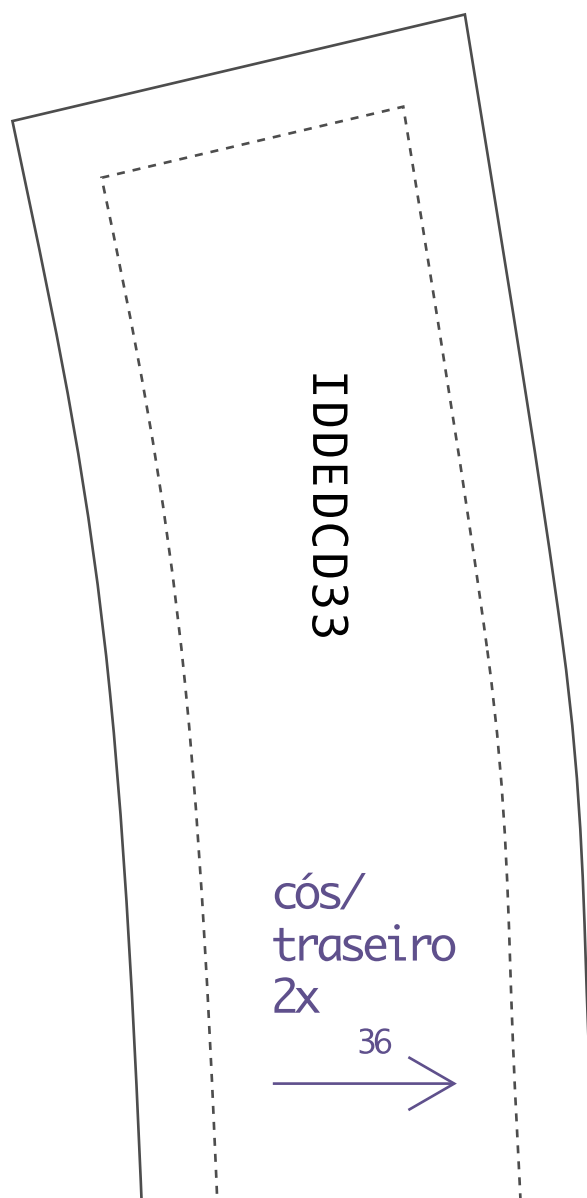

2-13

dobra

espelho/bolso 2x
36

IDDED CD33

