

Teste de impressão: ao imprimir seu molde, meça o quadrado que deverá ter a mesma medida informada (4cm), assim você se certificará que ele foi impresso no tamanho correto.

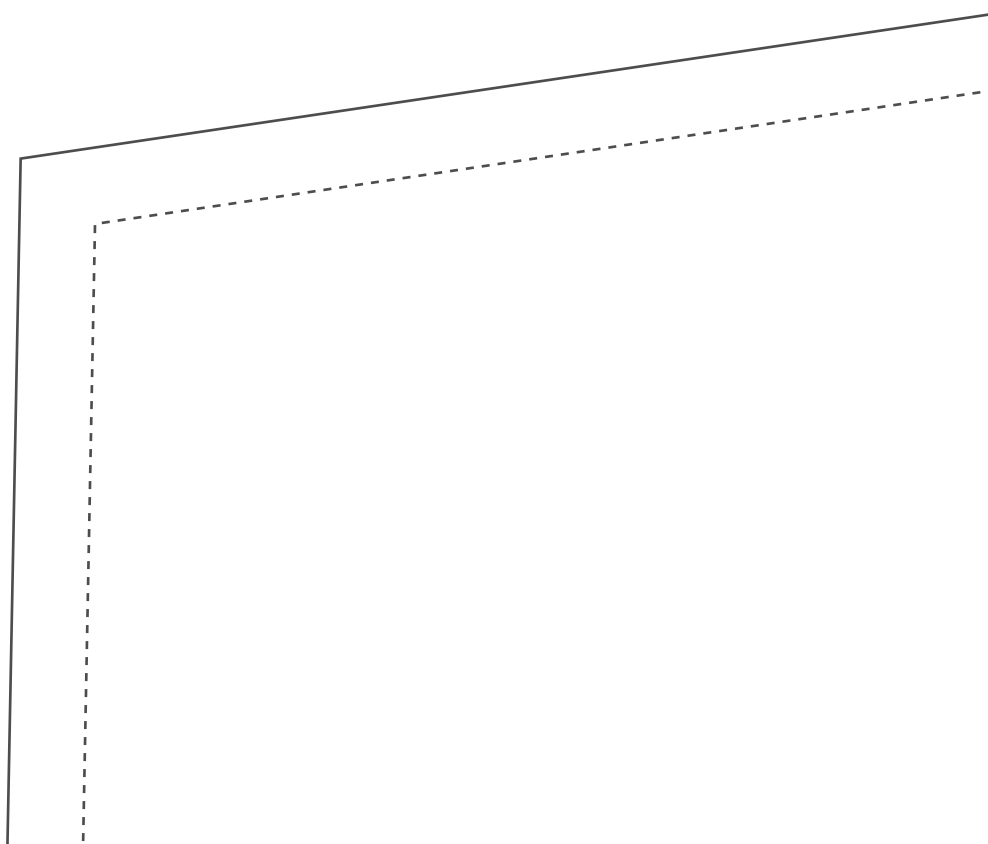

2-1

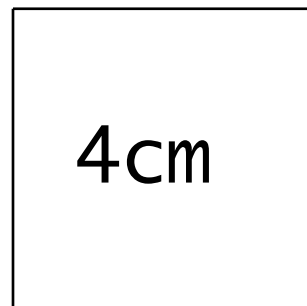

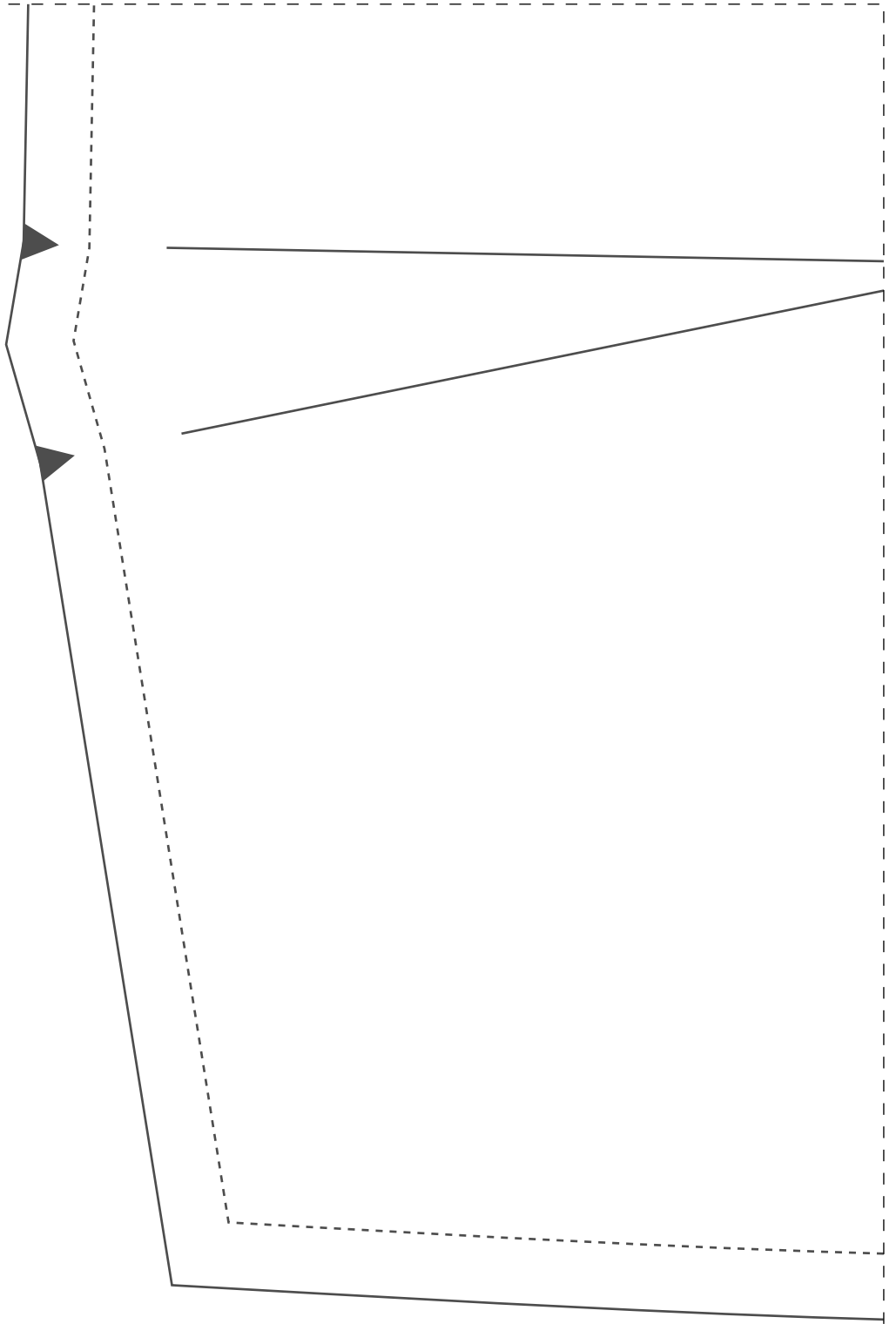
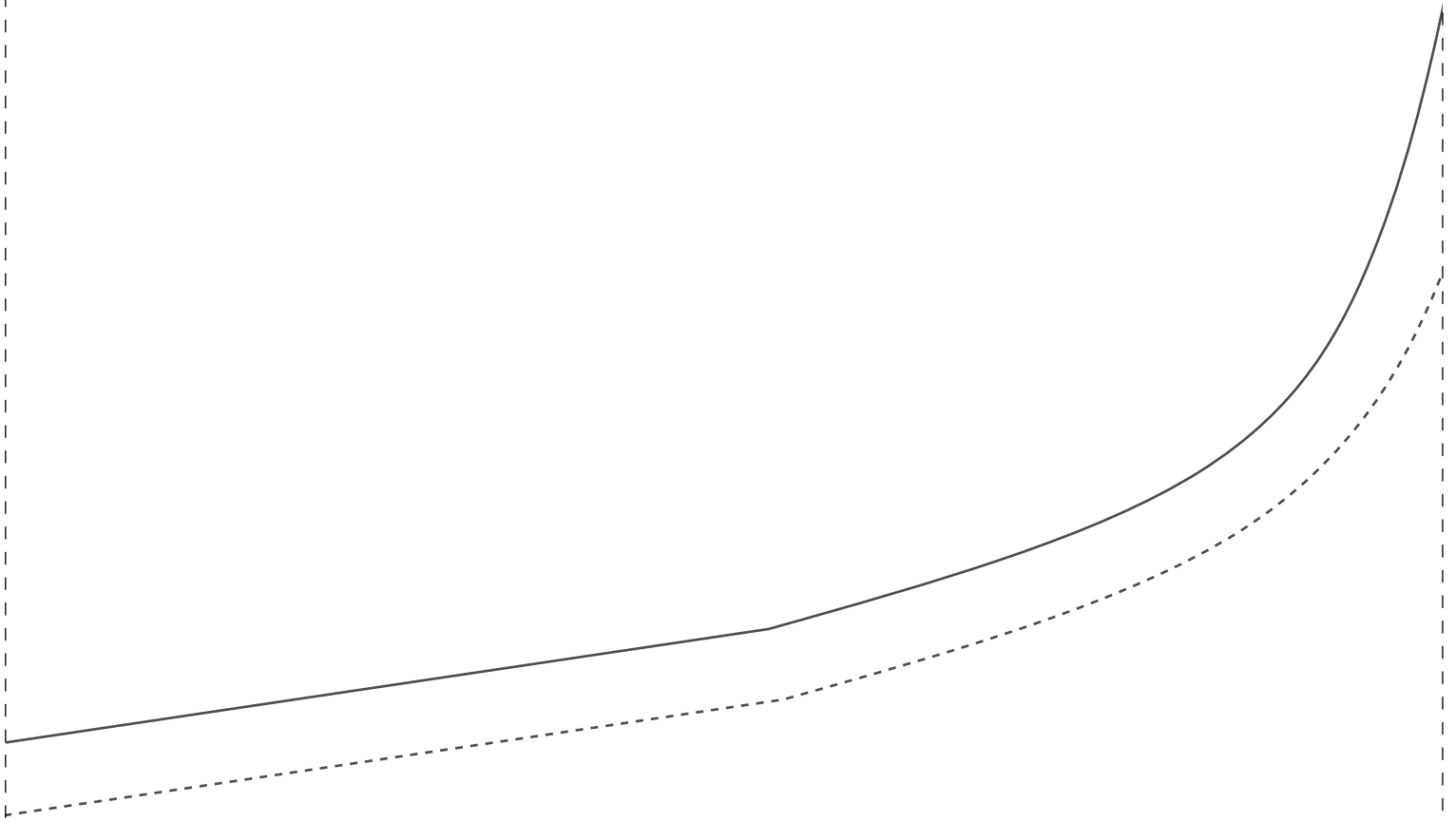



1-3

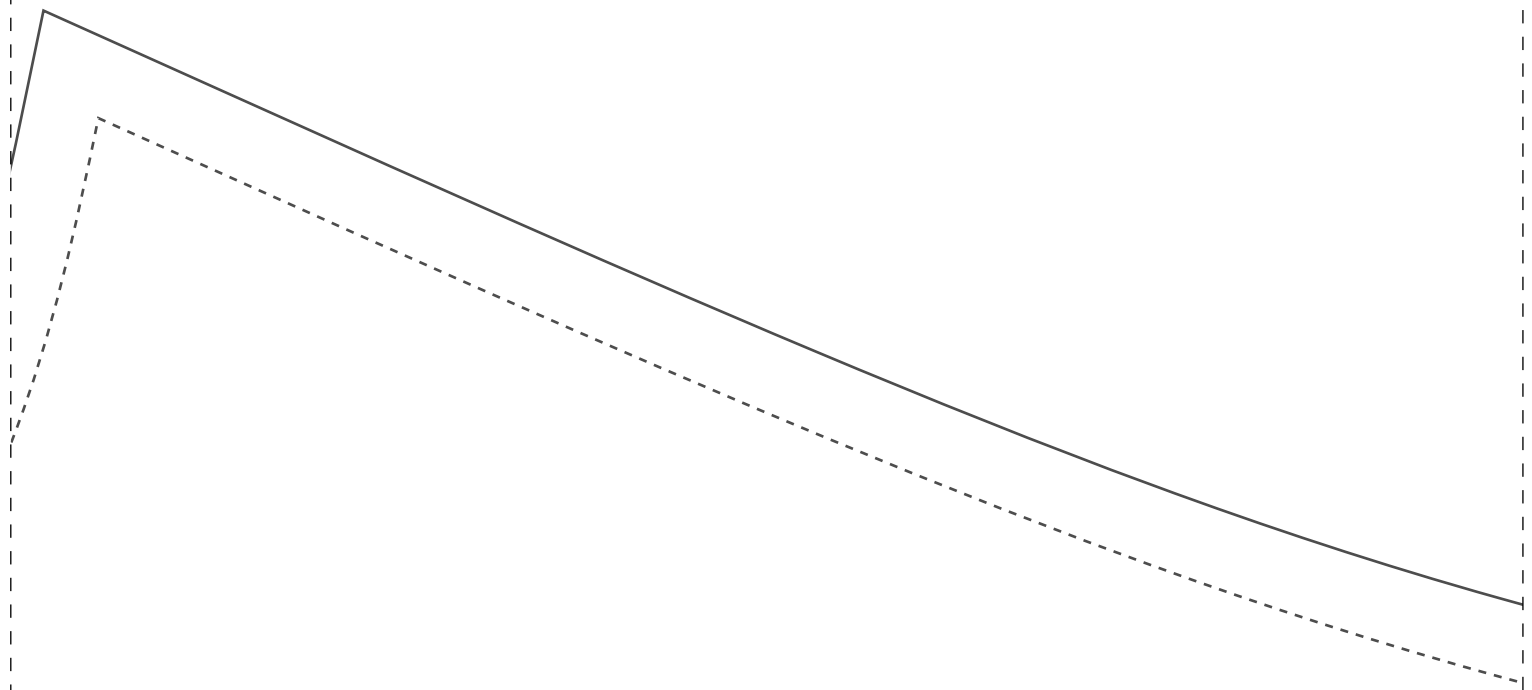

Time

Ficha Técnica:

- Tecido Plano 1,4m de largura
- Linho, gabardine, alfaiataria ou similares
- Bolso faca
- Cós entretelado (opcional)
- 1,6m para os tamanhos 36 ao 42
- 2m para os tamanhos 44 ao 54
- 1 zíper comum 15cm

1-4

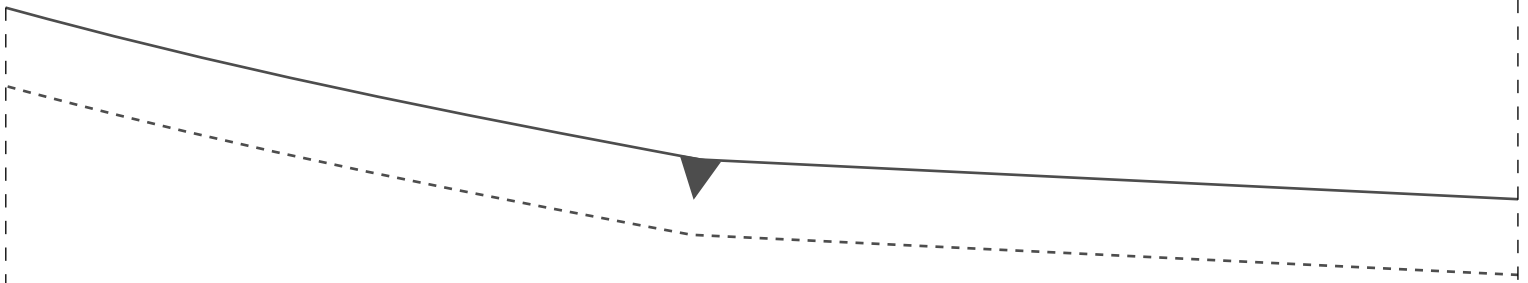

line 2x



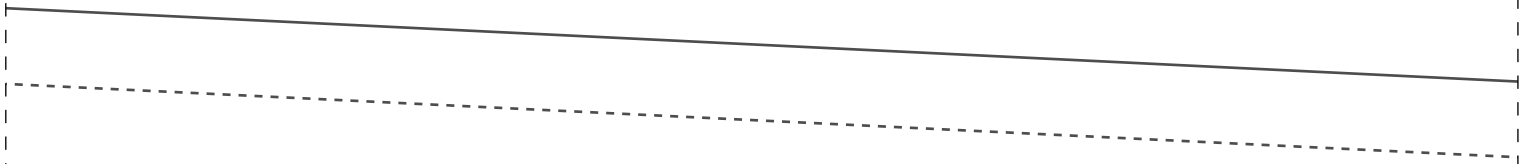

2-5



IDDED CD33

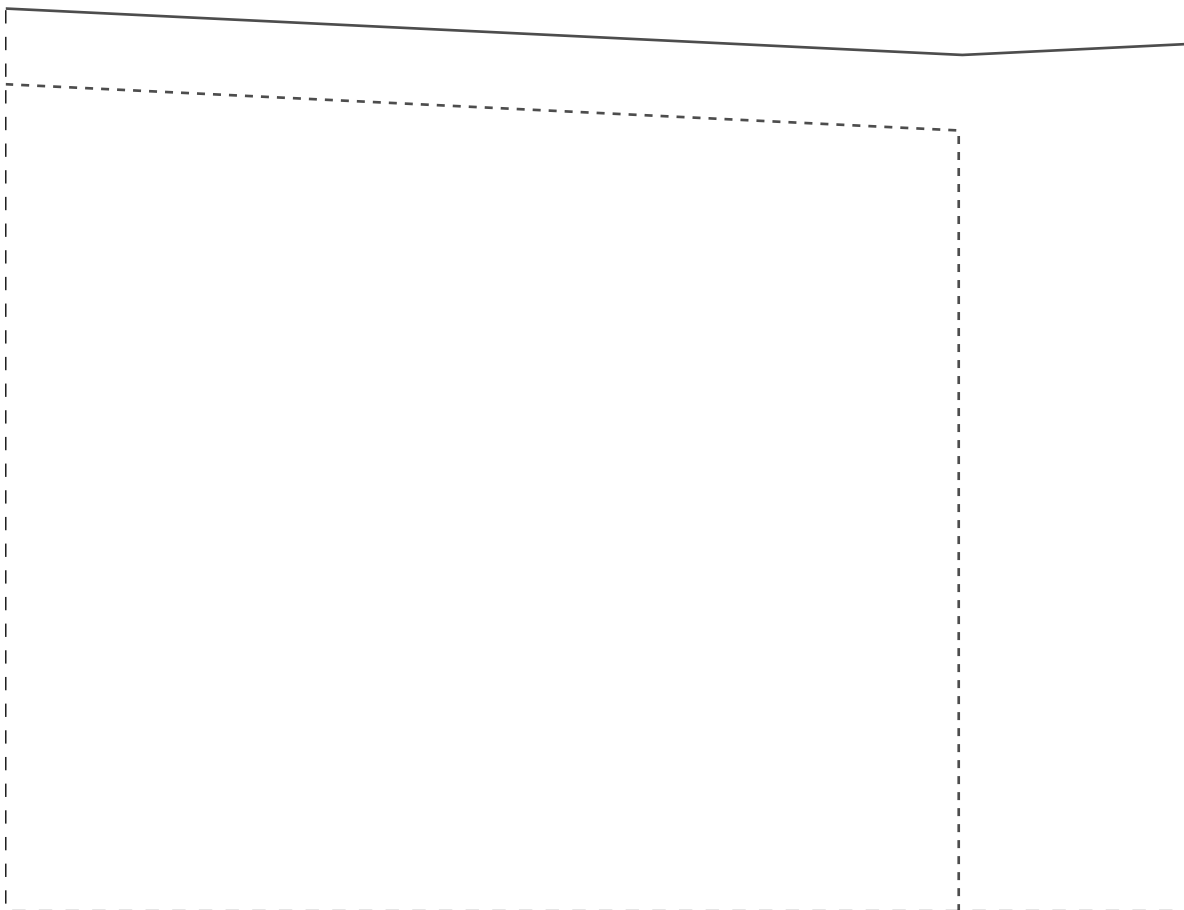

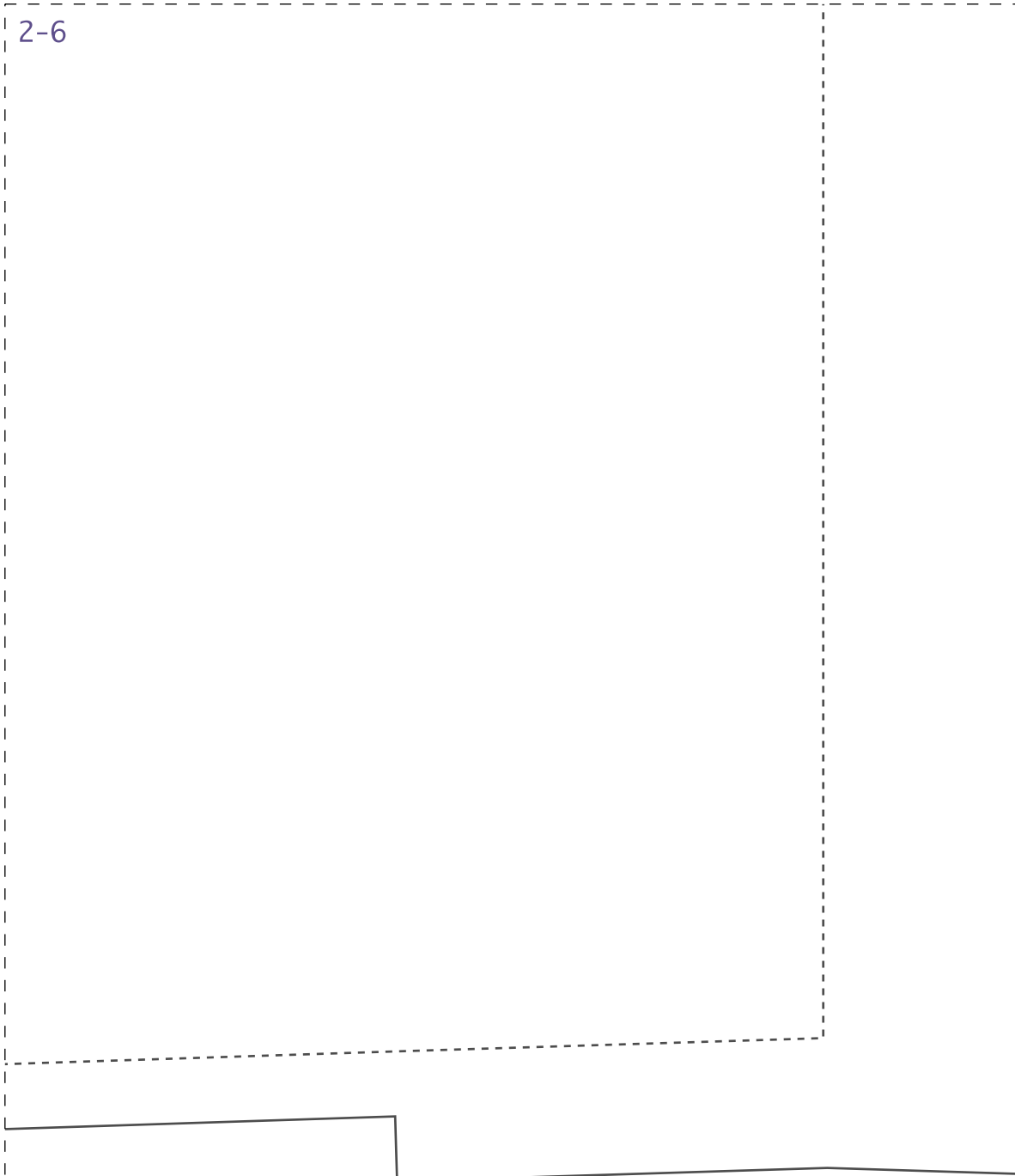
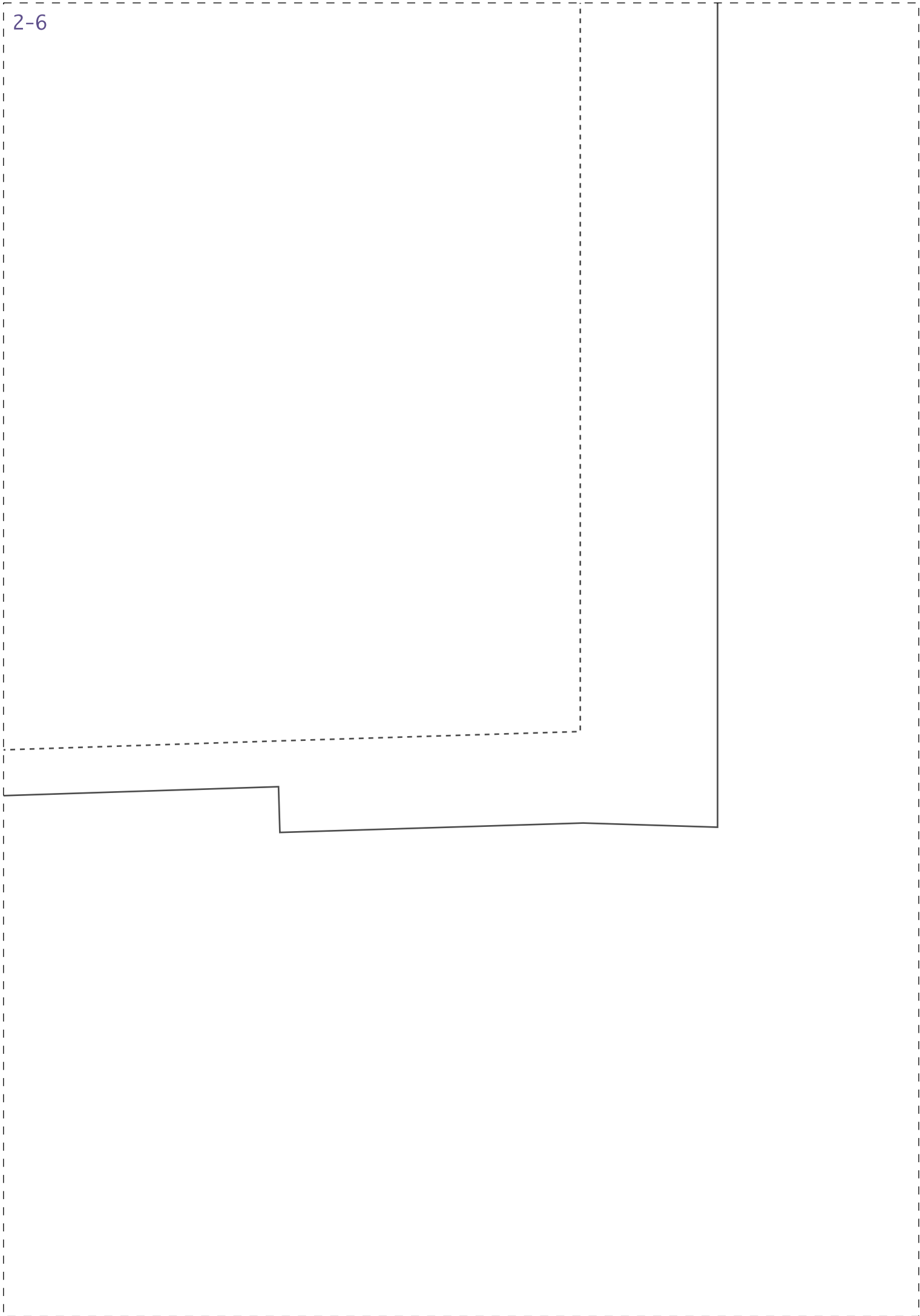

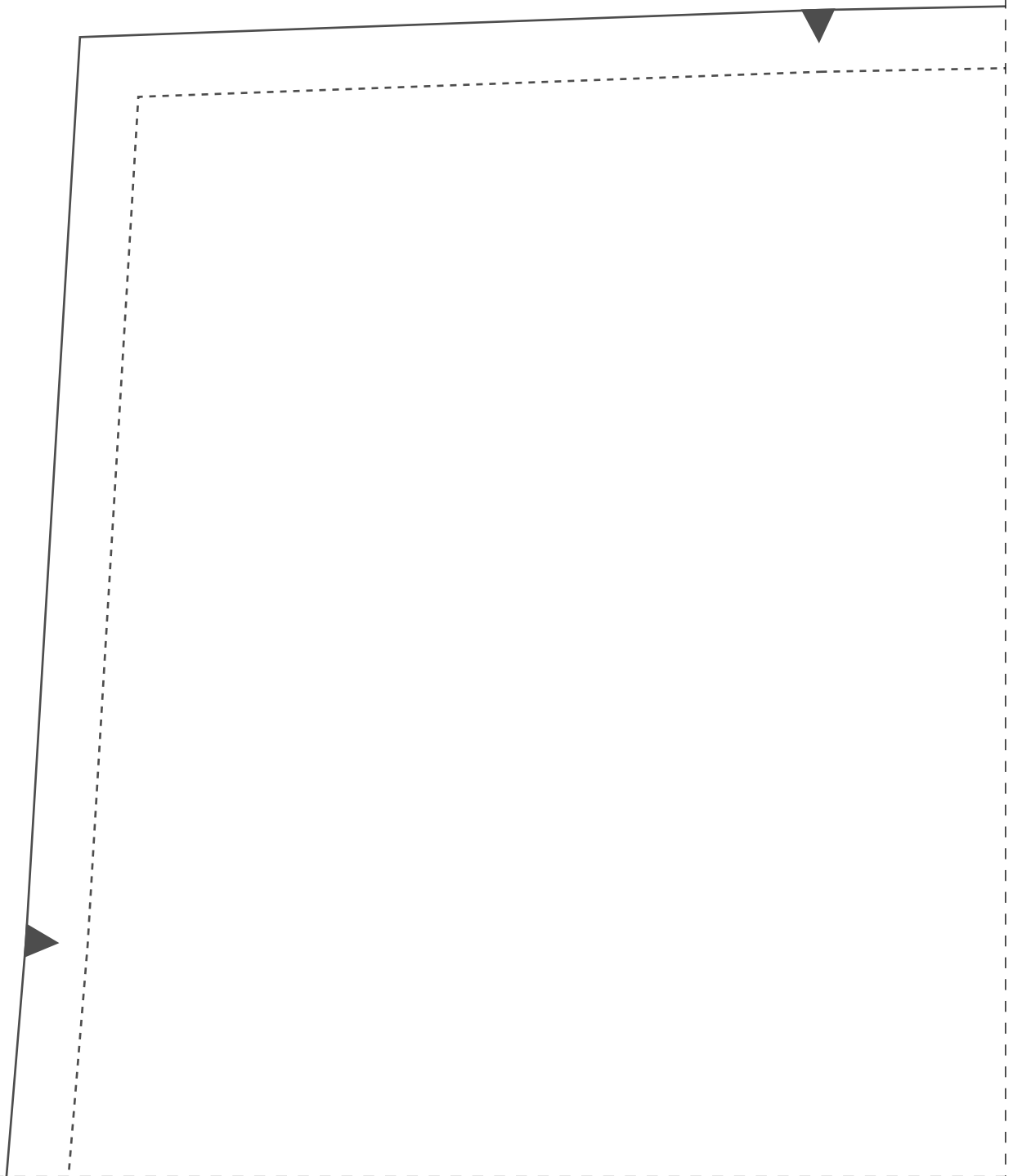

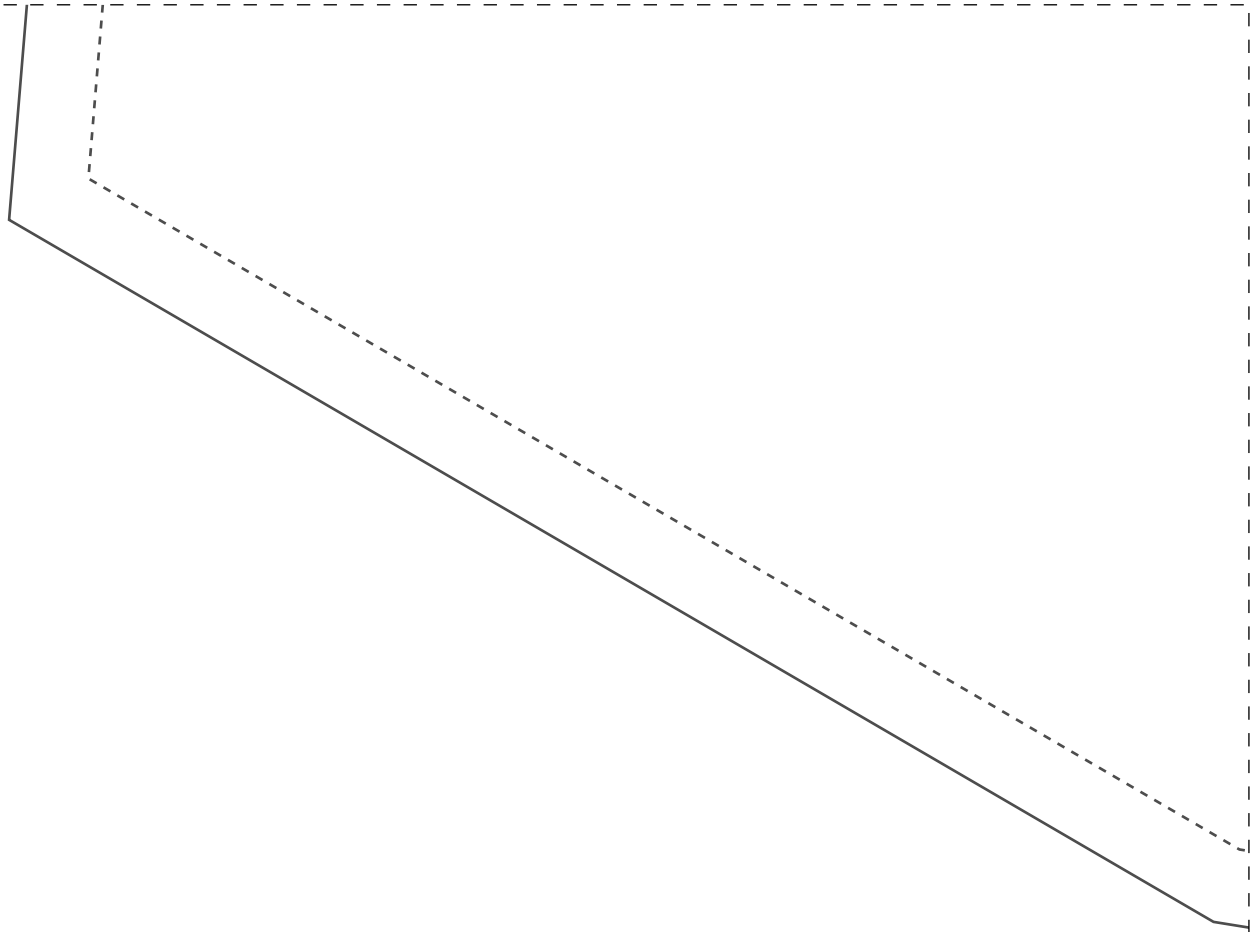

IDDED CD33

passante 4x

46



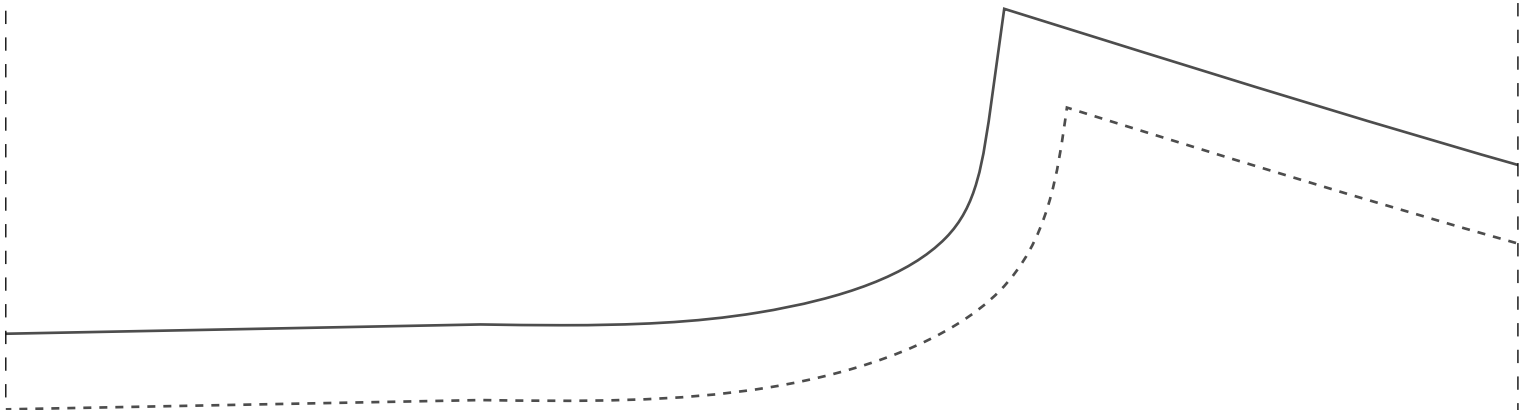

Instituto Diana Demar
Escola de Costurar
IDD Fashion Day
Calça Feminina Alfaia

PROIBIDA REVENDA

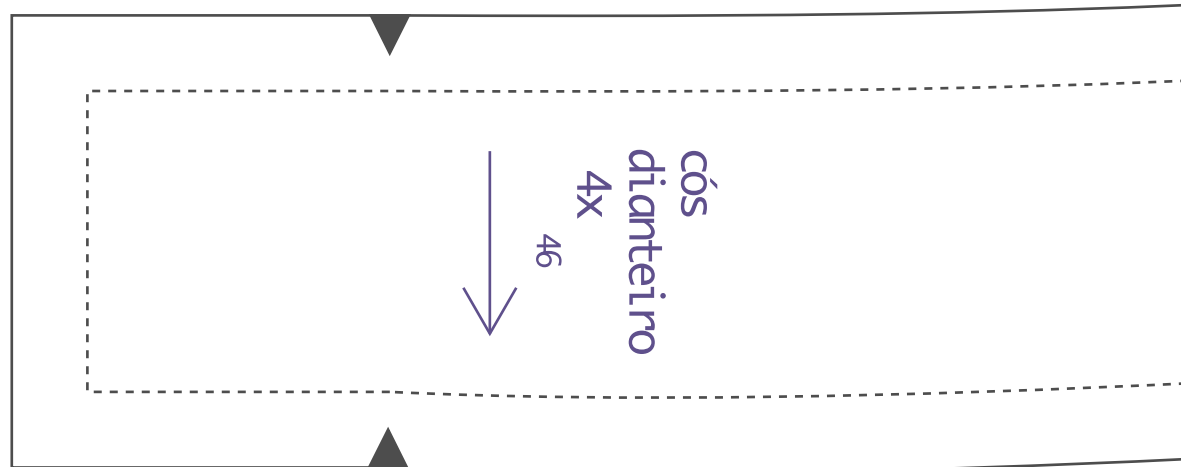

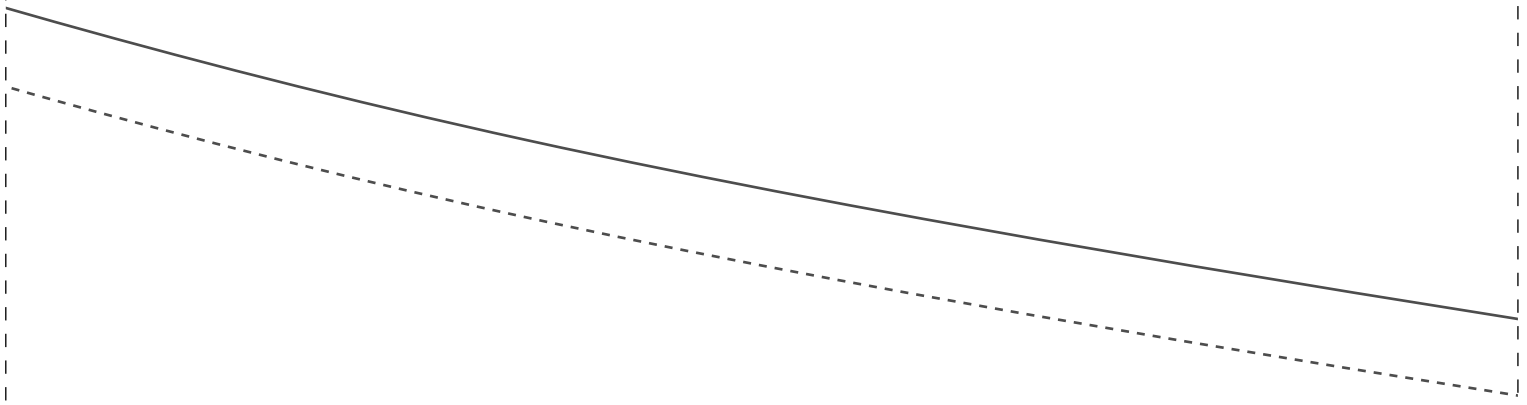

dianteiro 2x

46



chi

taria

IDDED CD33

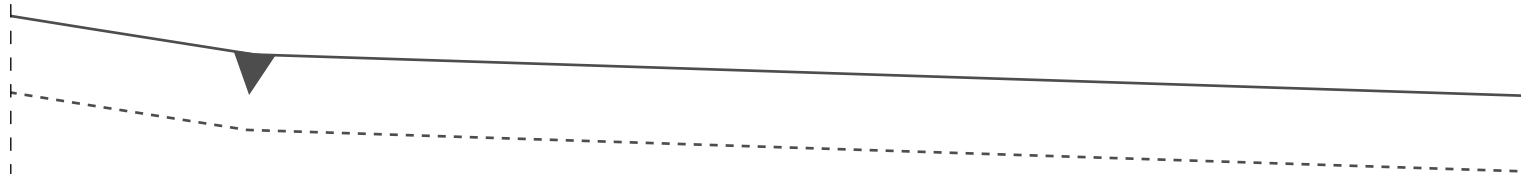

IDDED CD33

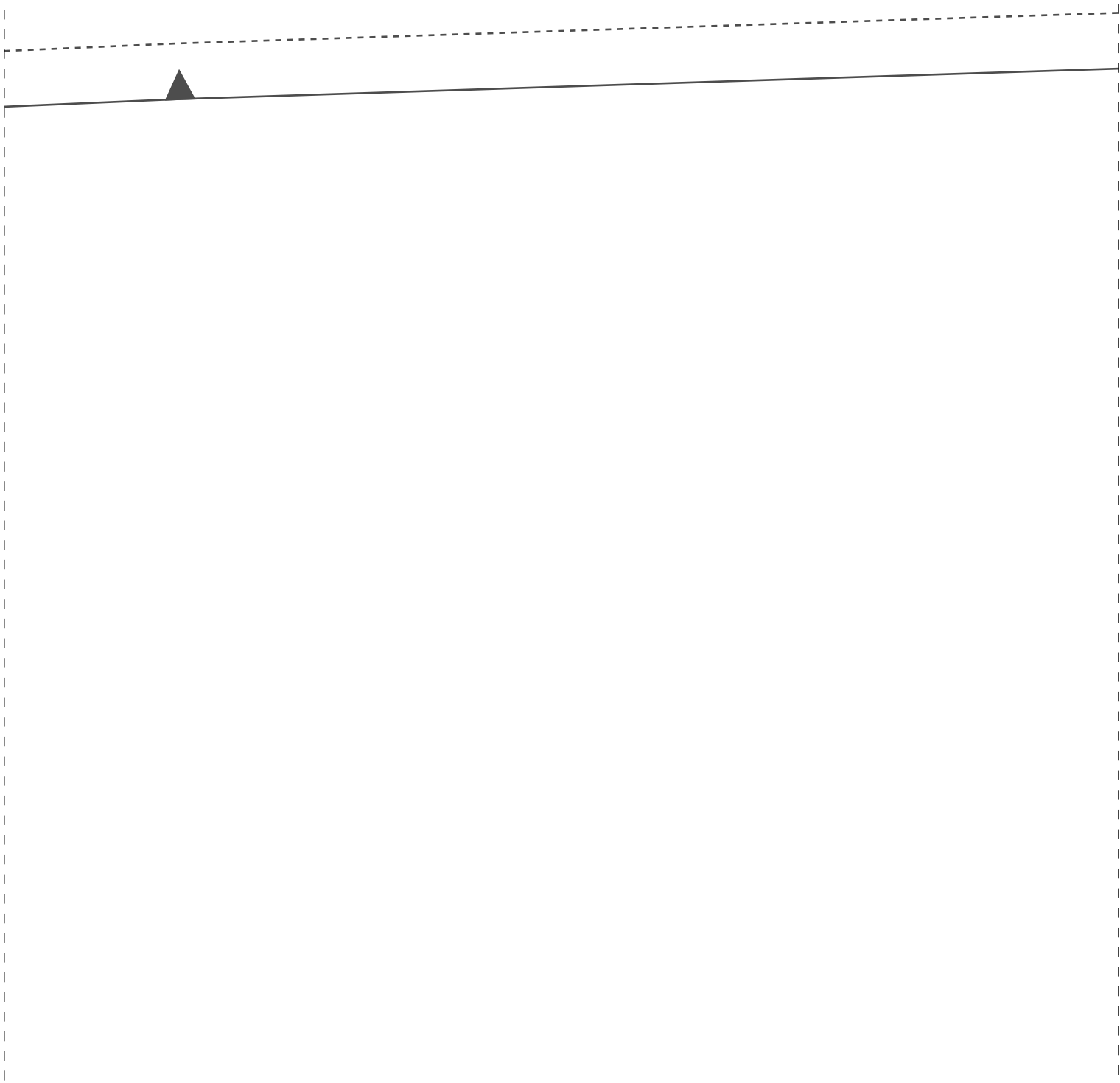

1-11

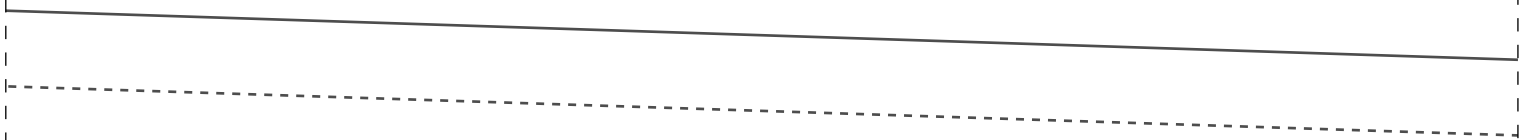



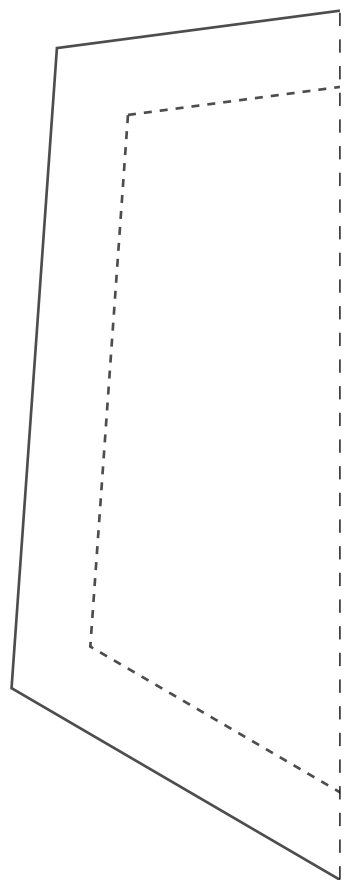
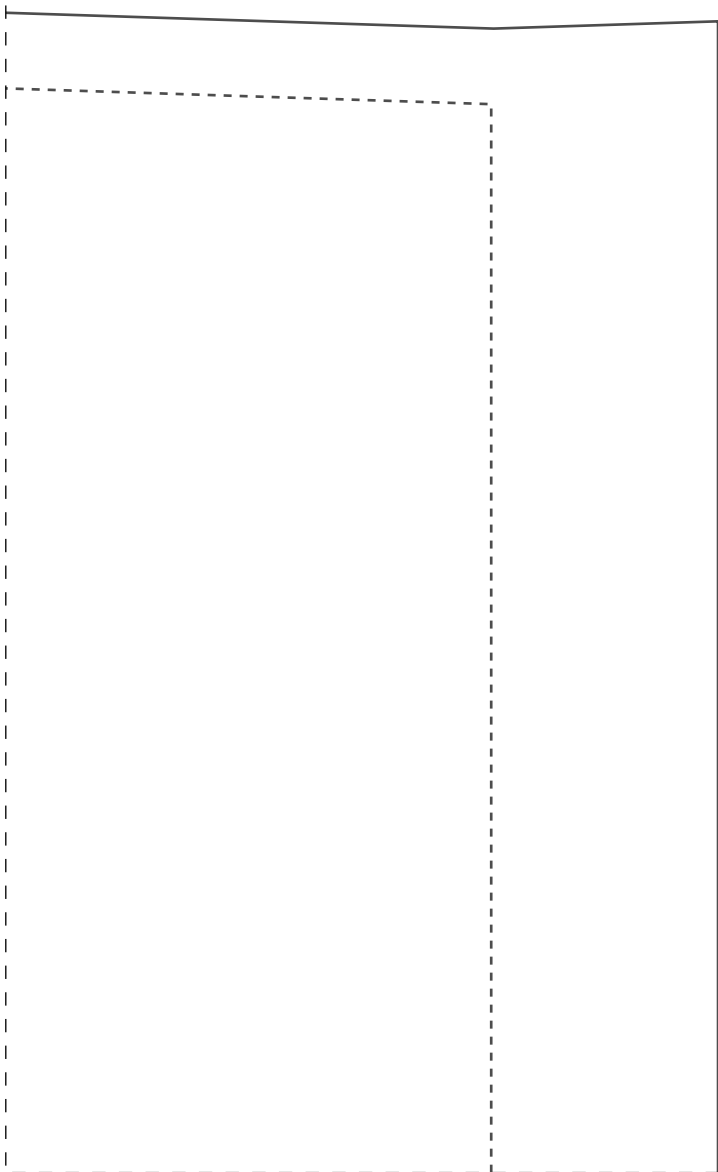

2-12

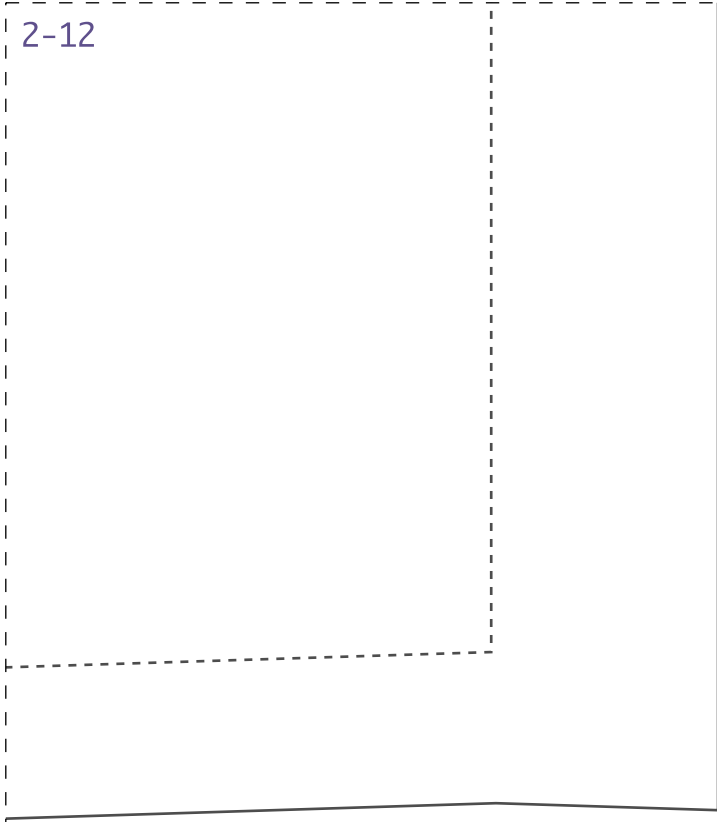

1-13

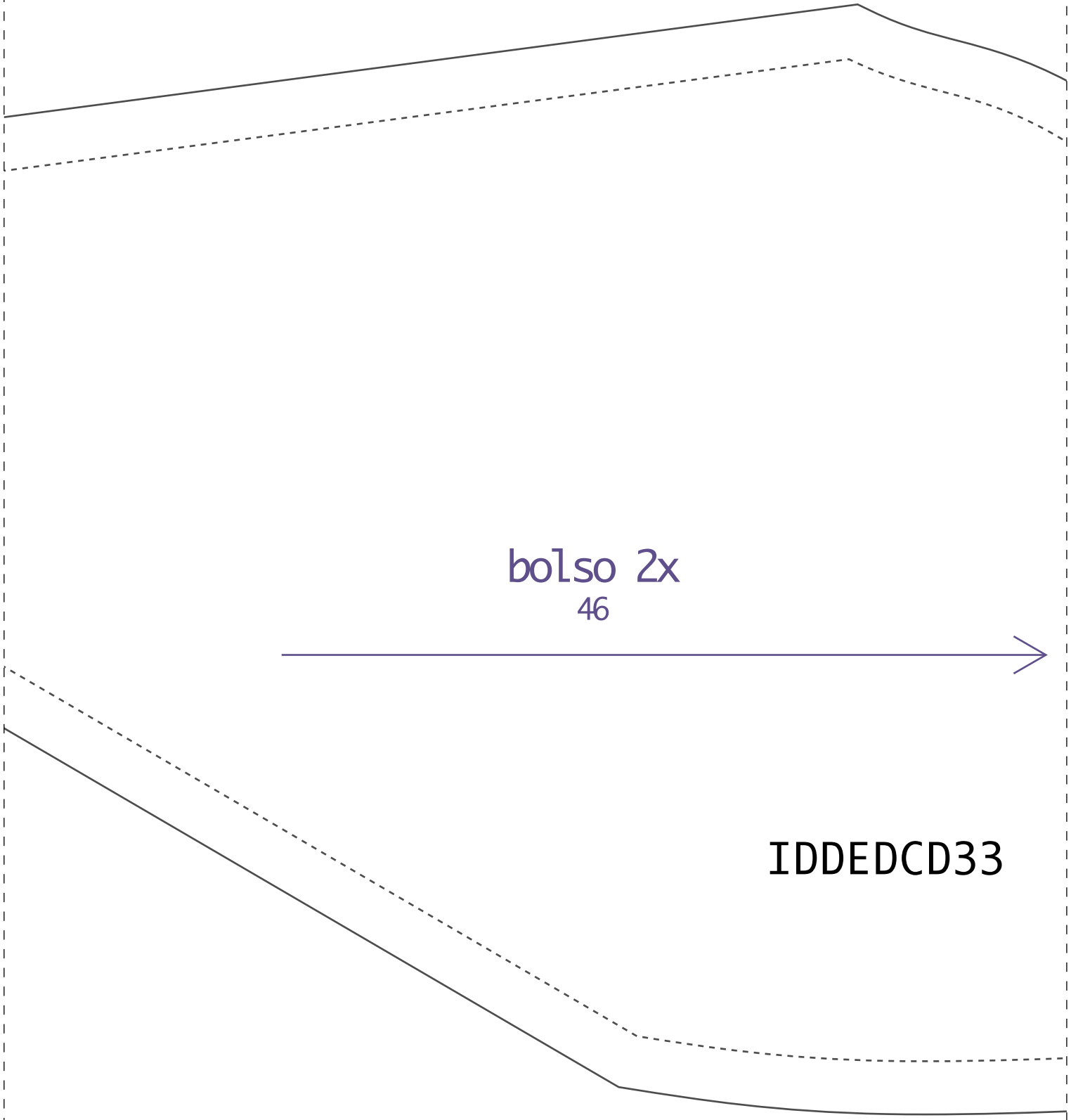

bolso 2x
46

IDDED CD33

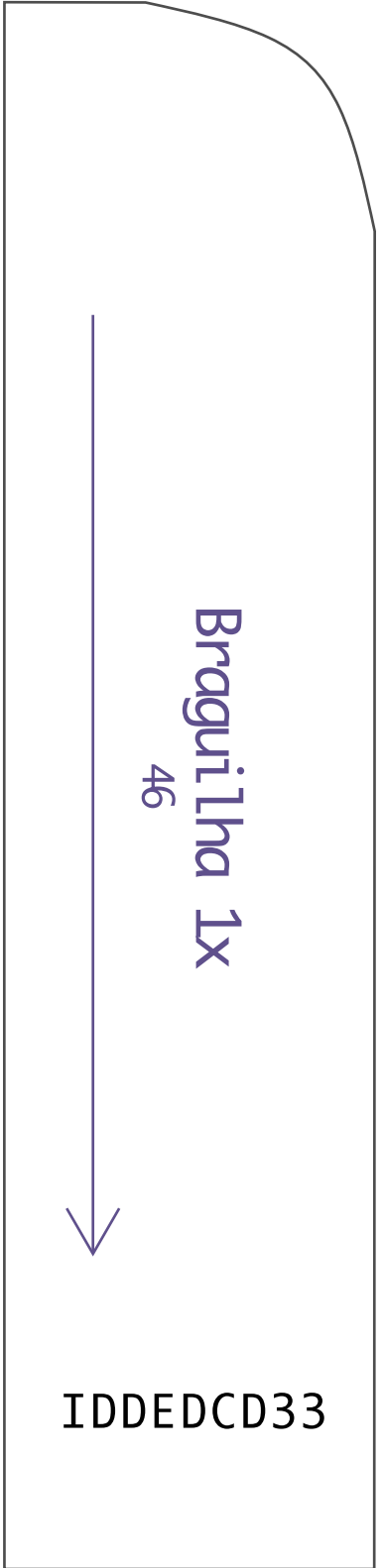

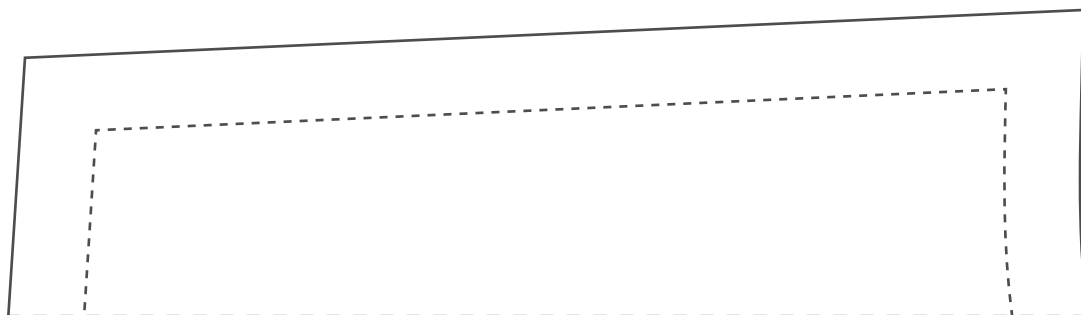
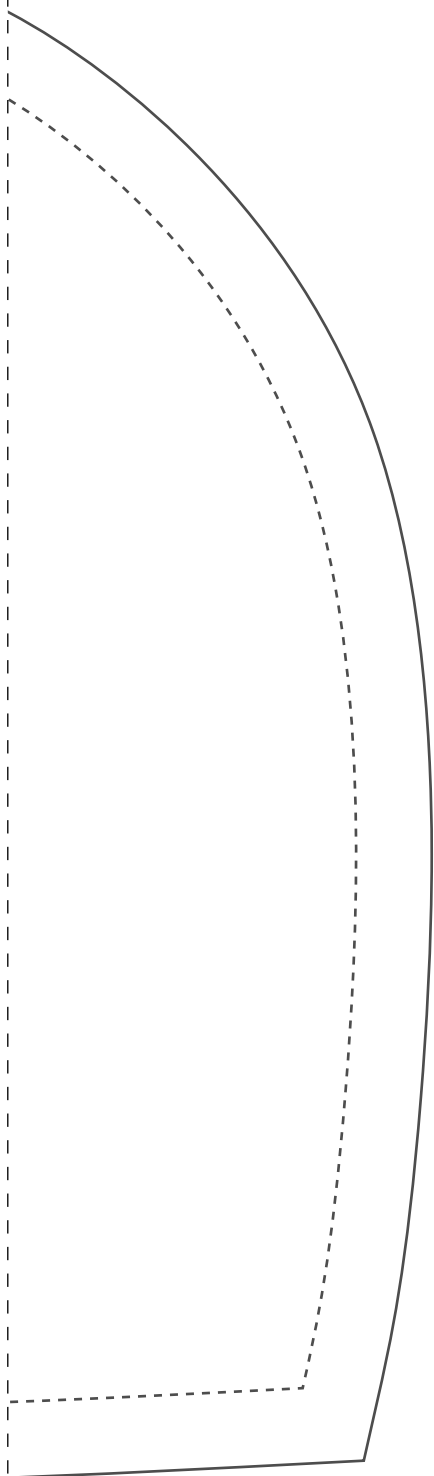

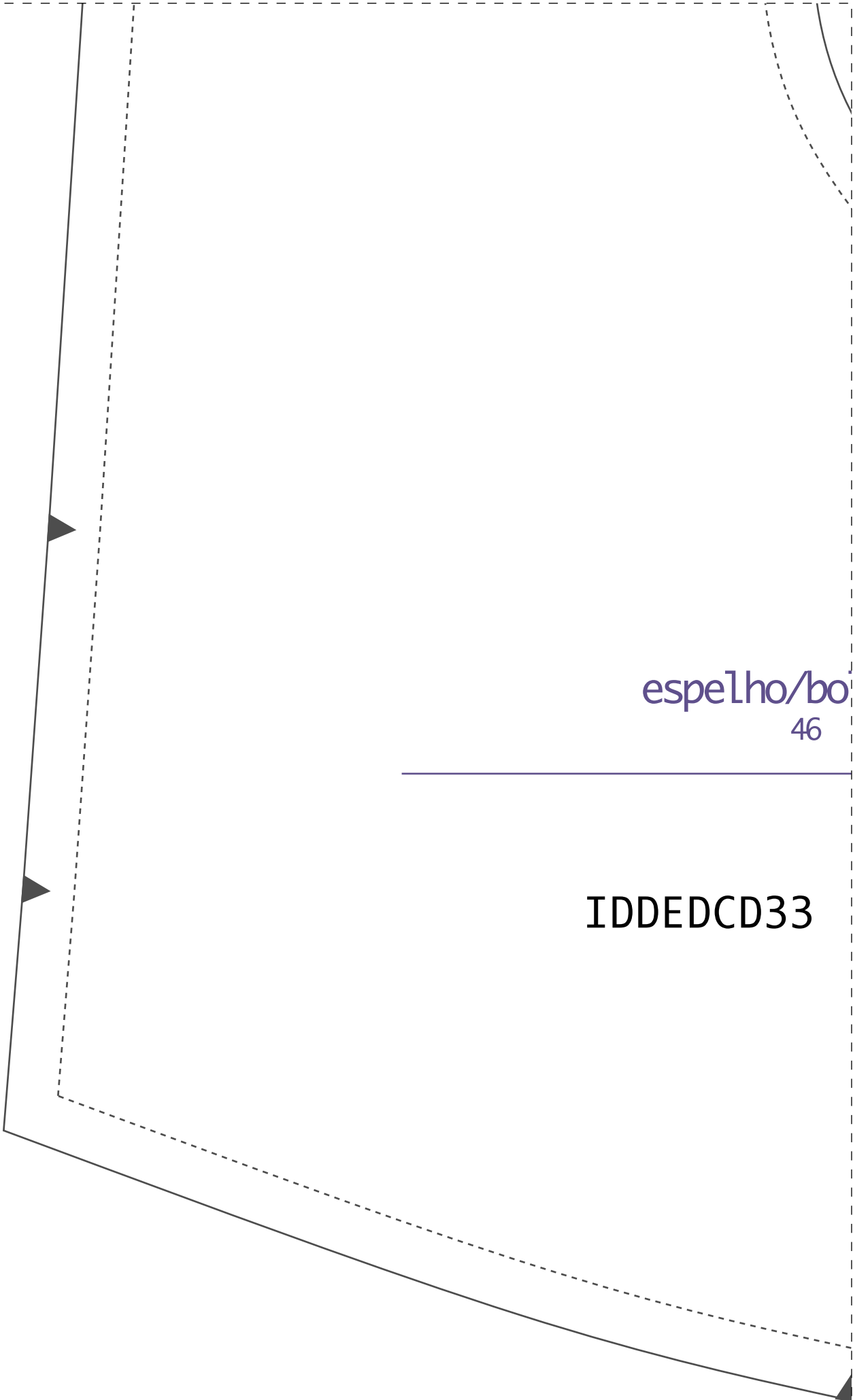

espelho/bo
46

IDDED33

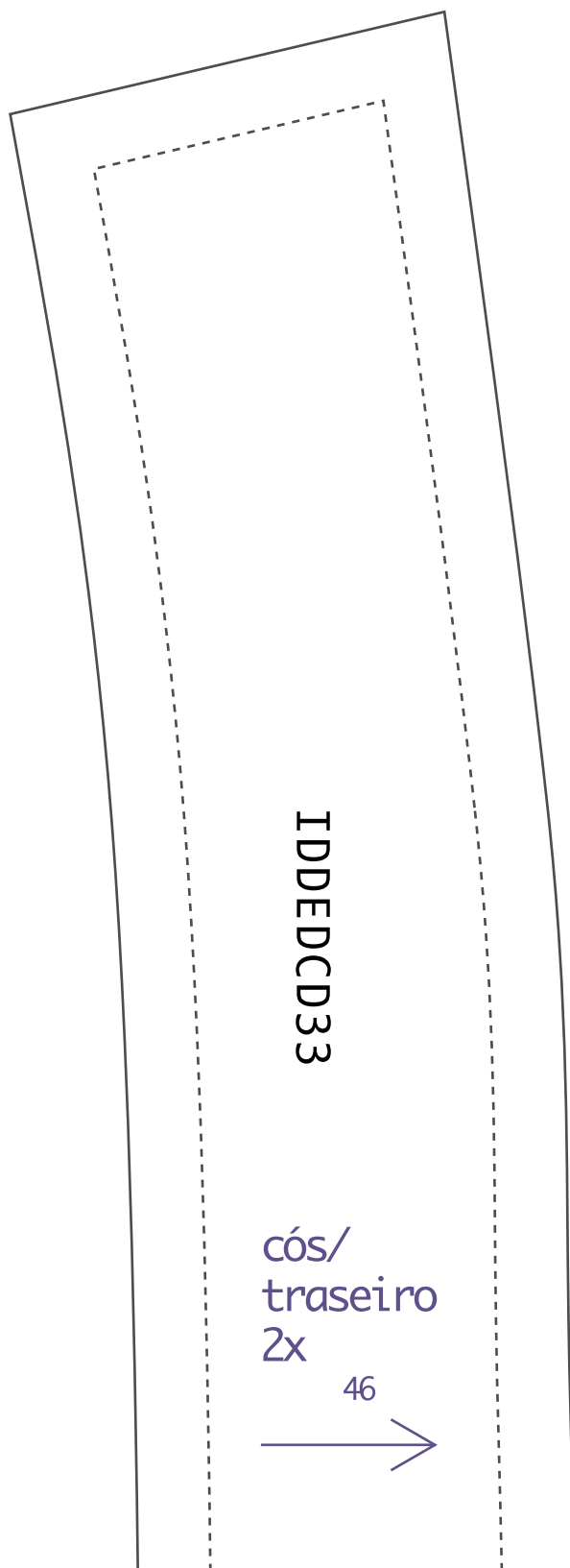

IDDEDCCD33

cós/
traseiro
2x

46



2-15

dobra

Iso 2x

