

Teste de impressão: ao imprimir seu molde, meça o quadrado que deverá ter a mesma medida informada (4cm), assim você se certificará que ele foi impresso no tamanho correto.

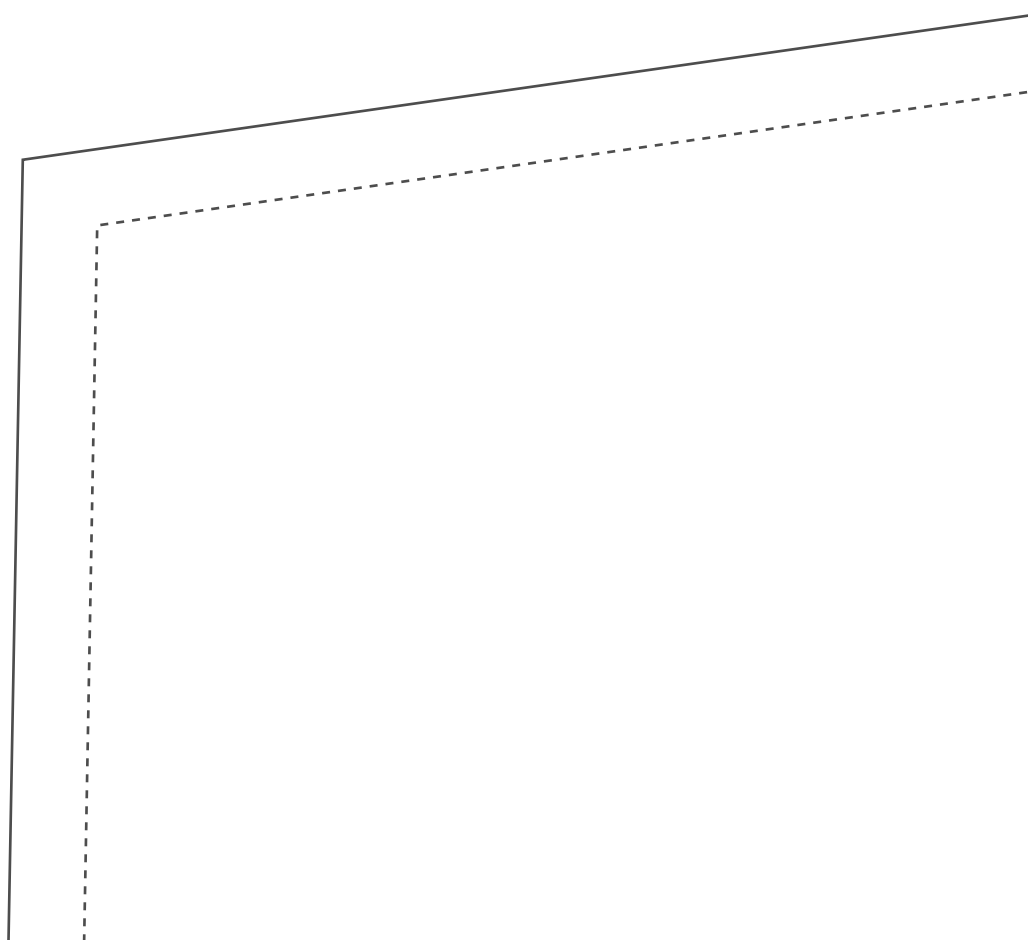

2-1

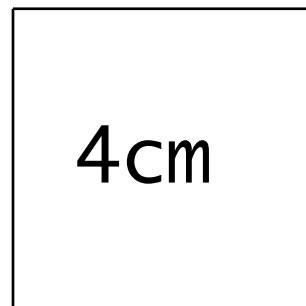
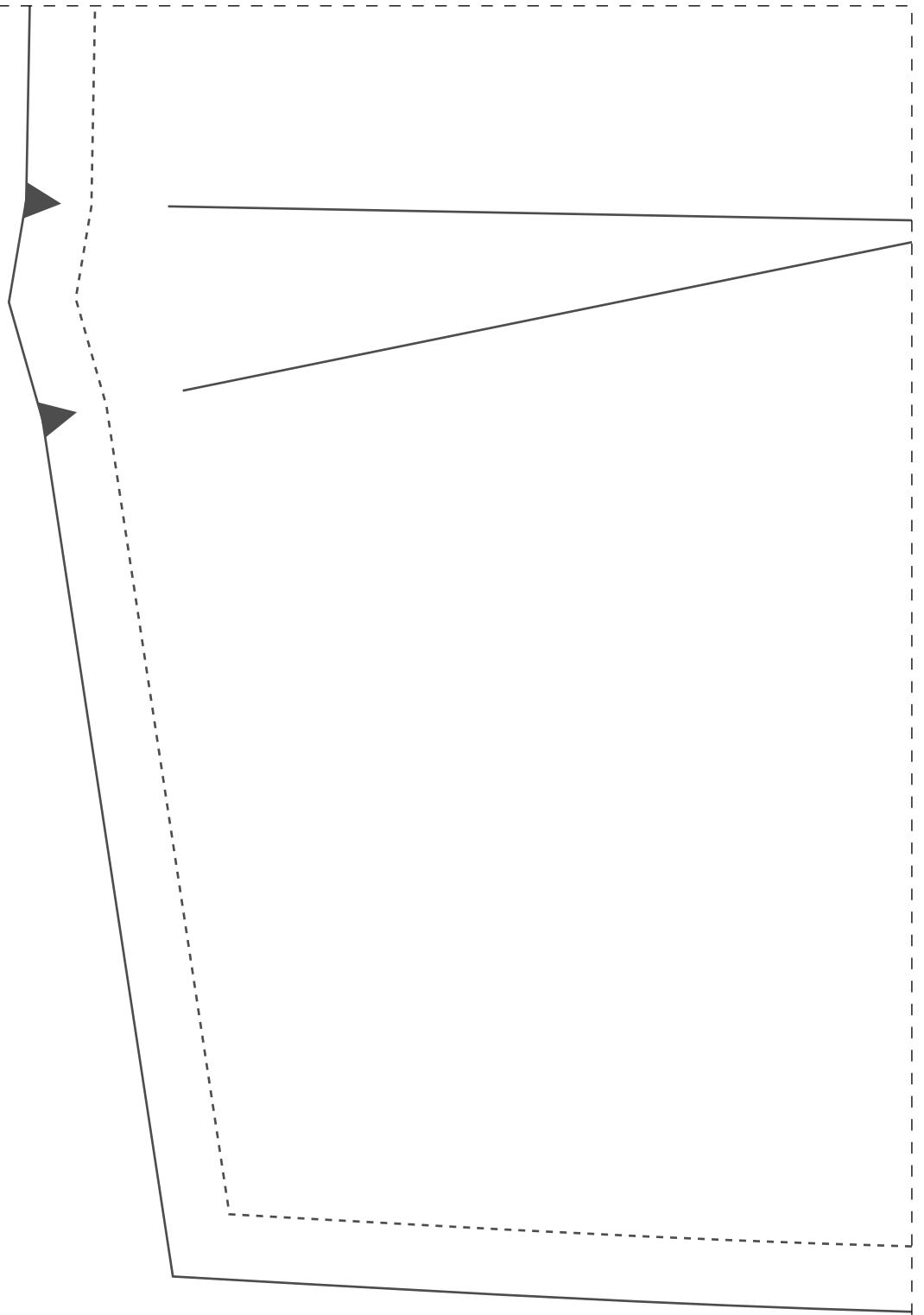

1-2

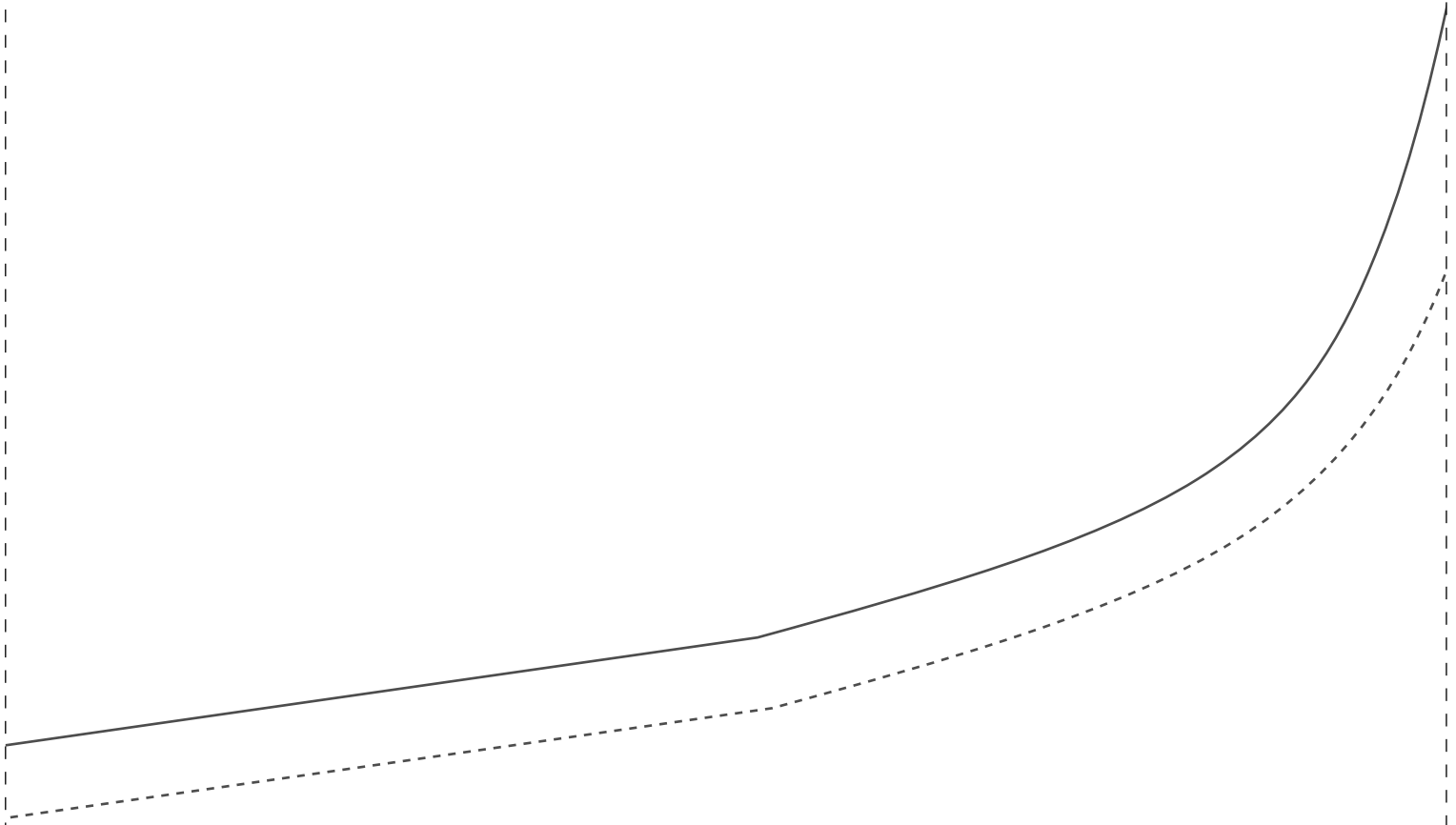



1-3

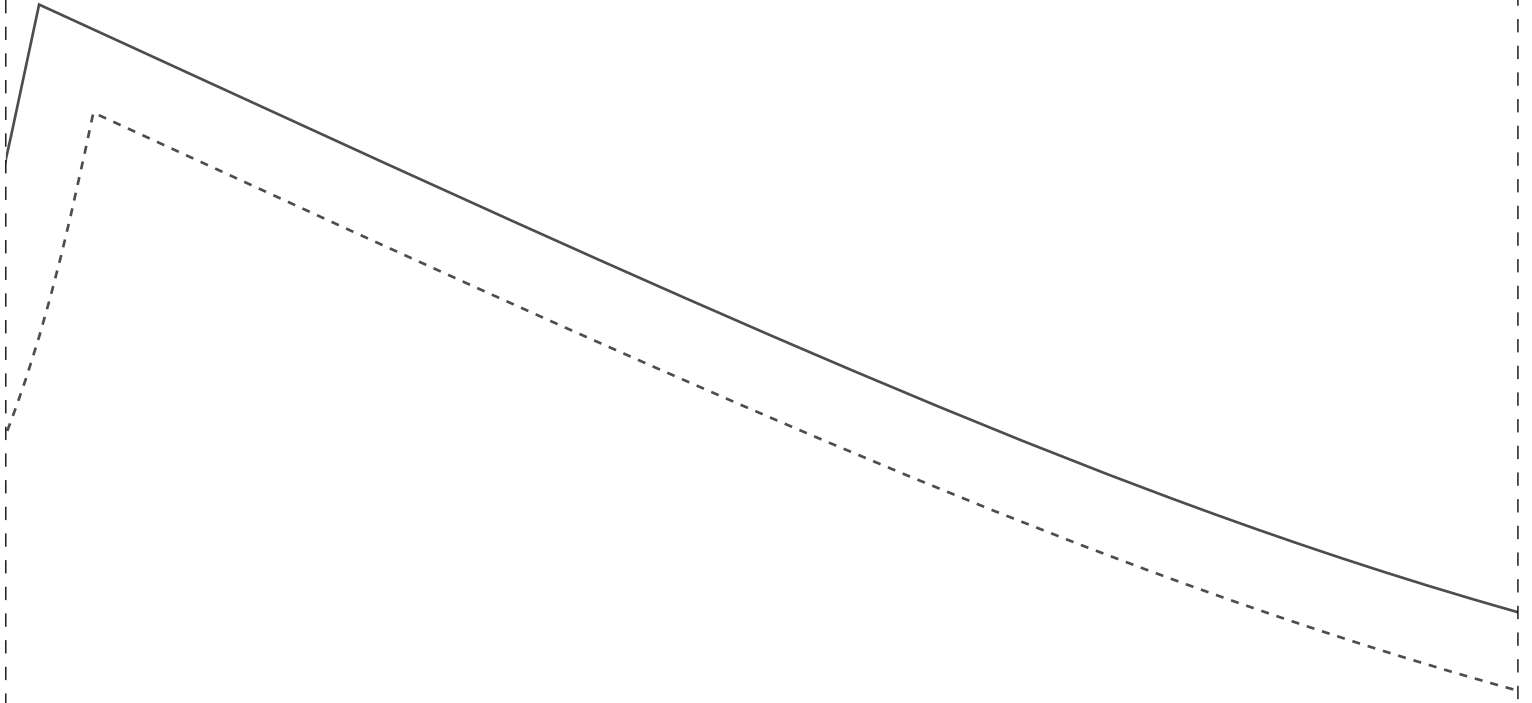

Time

## Ficha Técnica:

- Tecido Plano 1,4m de largura
- Linho, gabardine, alfaiataria ou similares
- Bolso faca
- Cós entretelado (opcional)
- 1,6m para os tamanhos 36 ao 42
- 2m para os tamanhos 44 ao 54
- 1 zíper comum 15cm

1-4

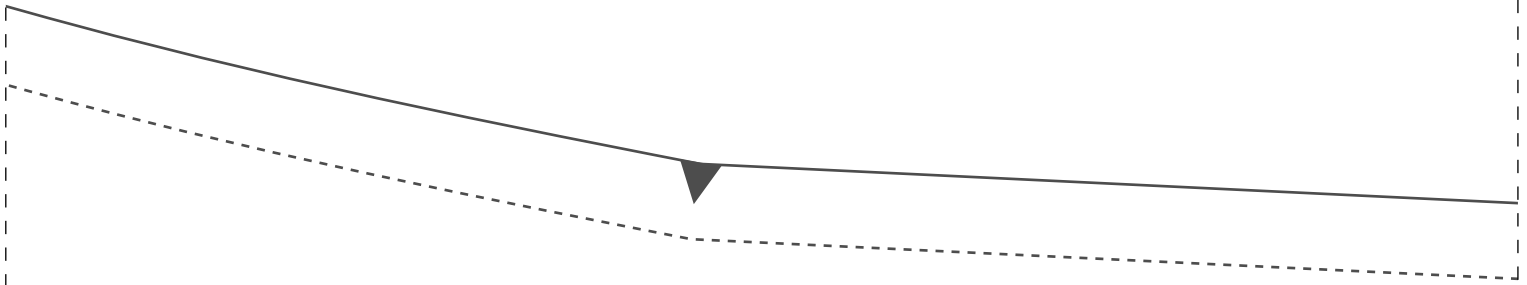

line 2x

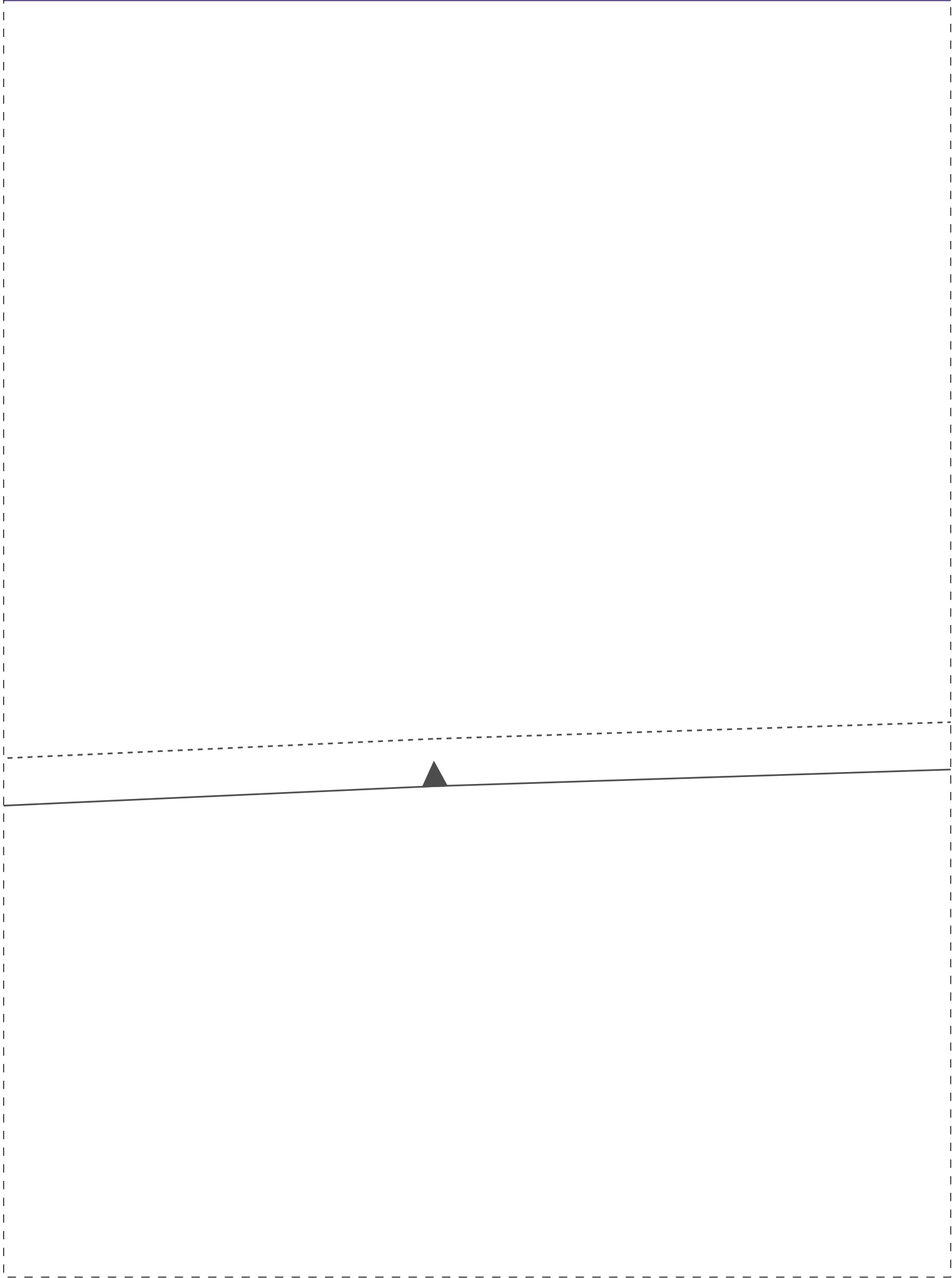



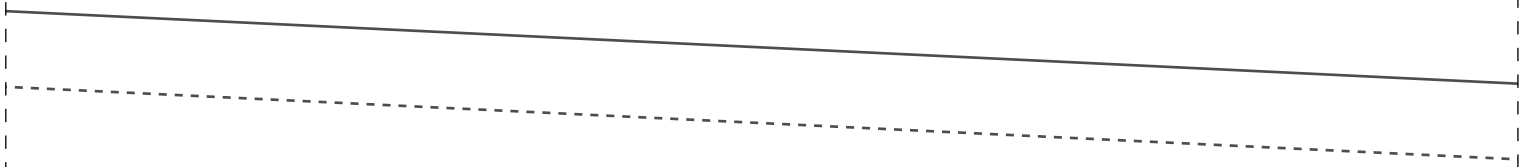

2-5



IDDED CD33



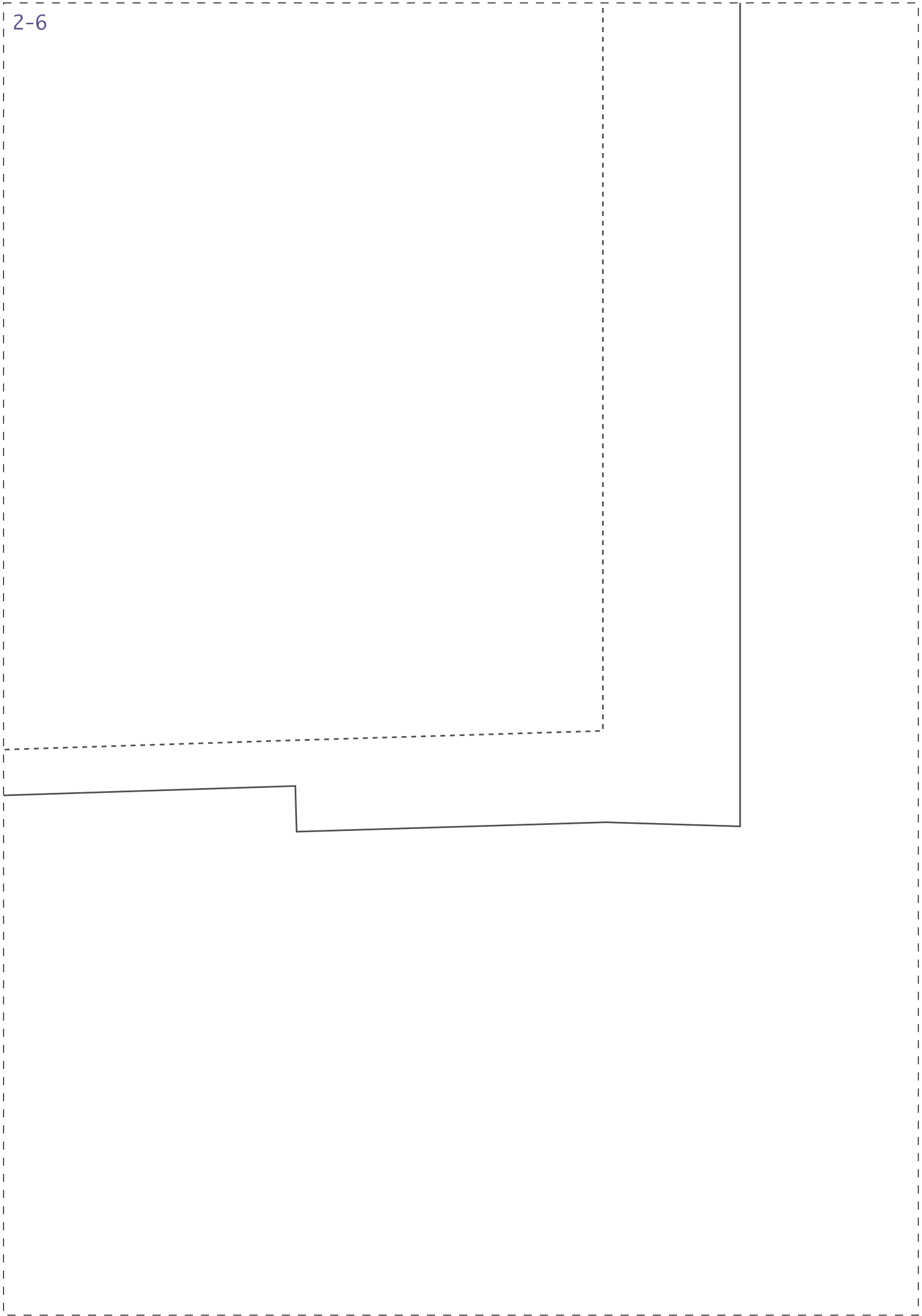

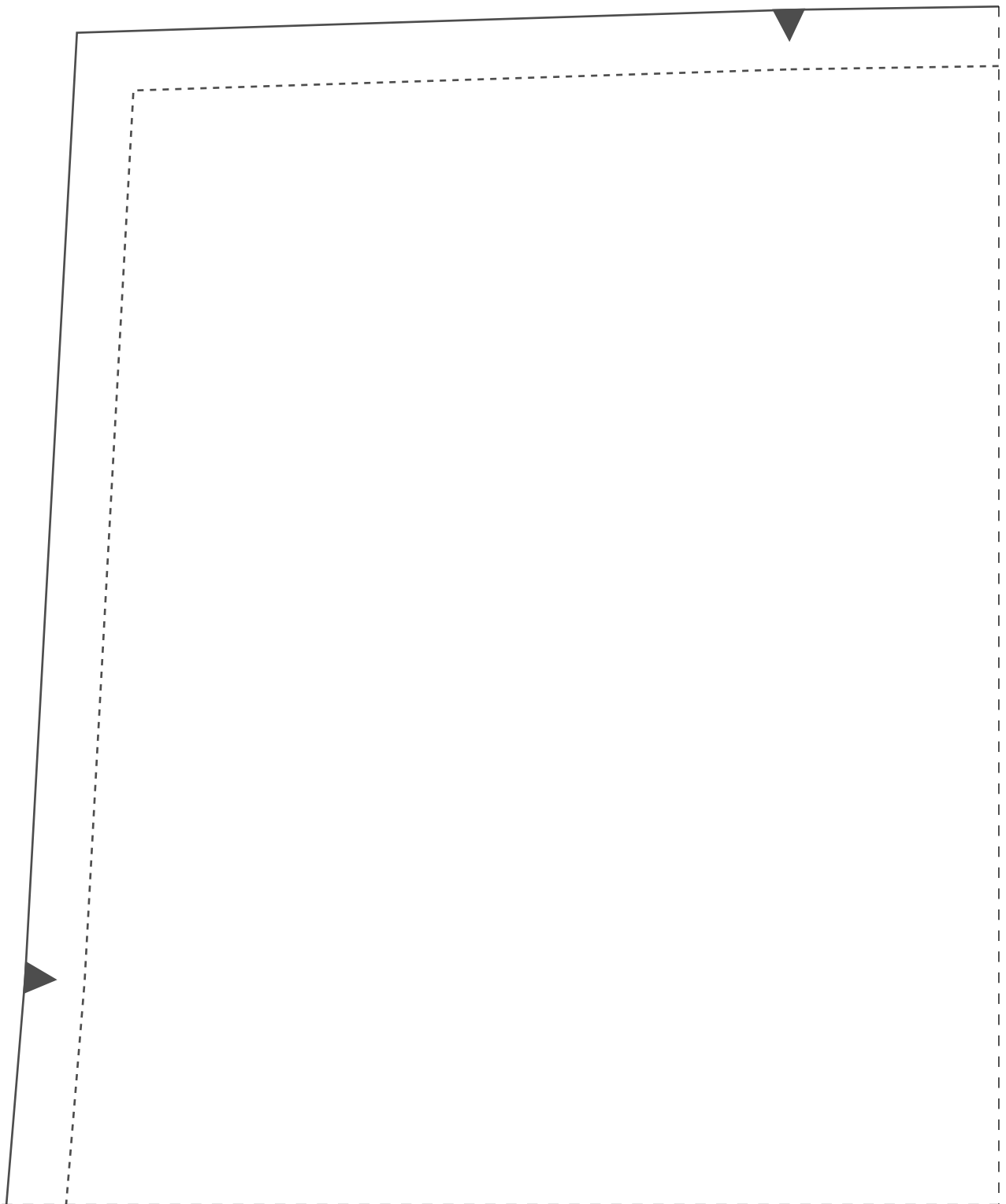

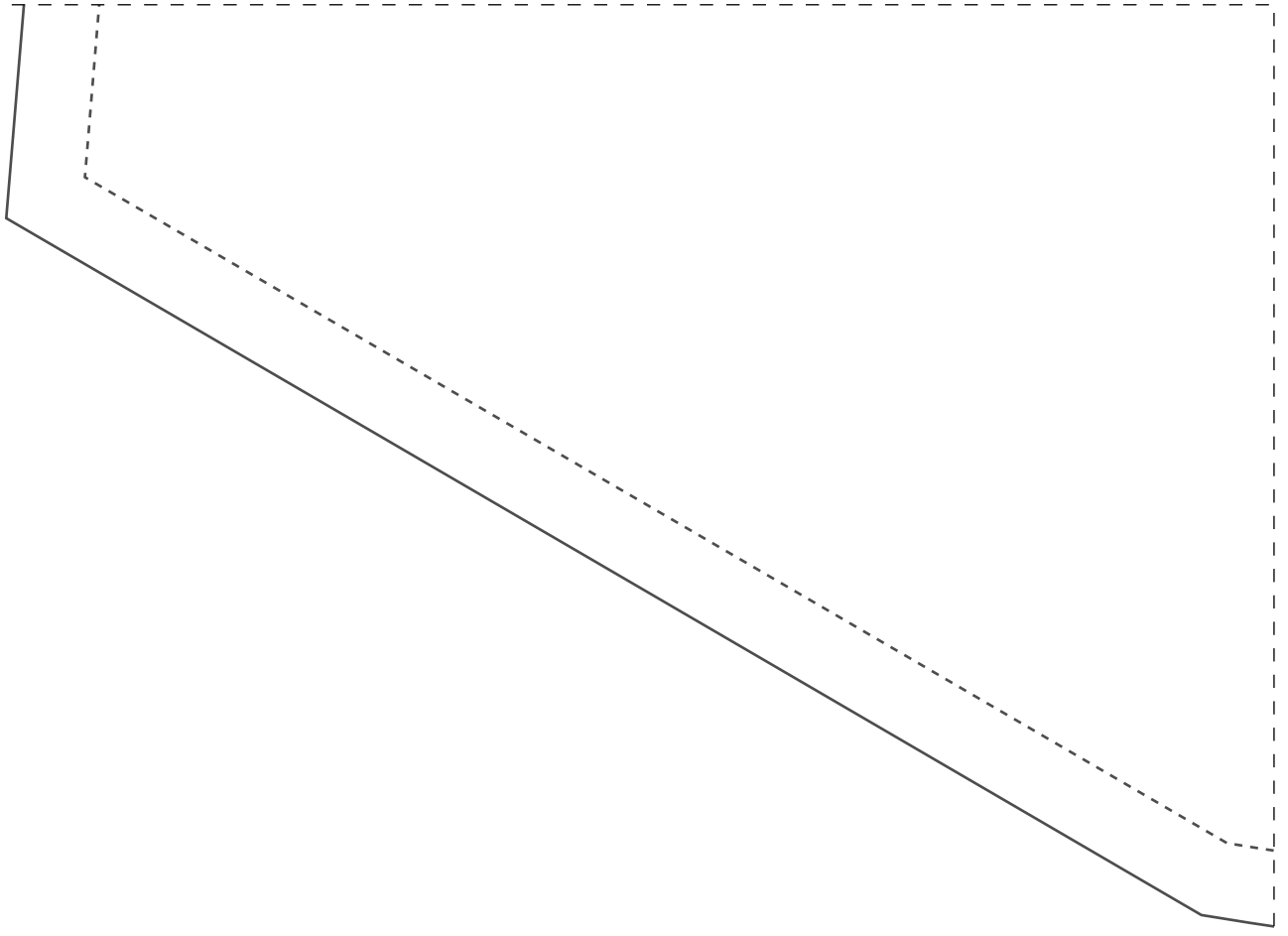

IDDED CD33

passante 4x

48



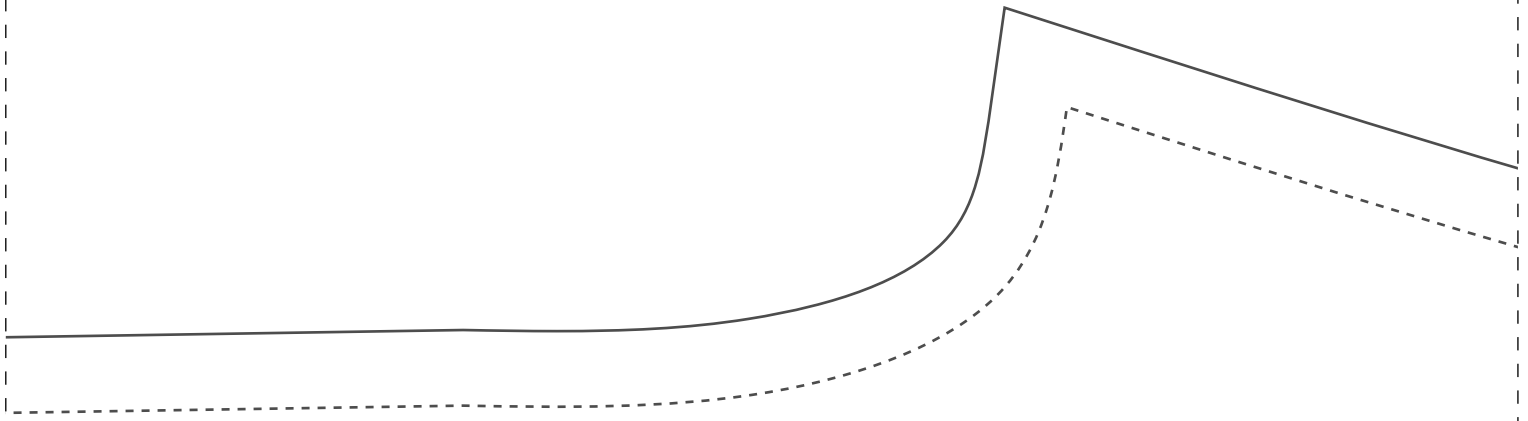

---

Instituto Diana Demar  
Escola de Costurar  
IDD Fashion Day  
Calça Feminina Alfaia

PROIBIDA REVENDA

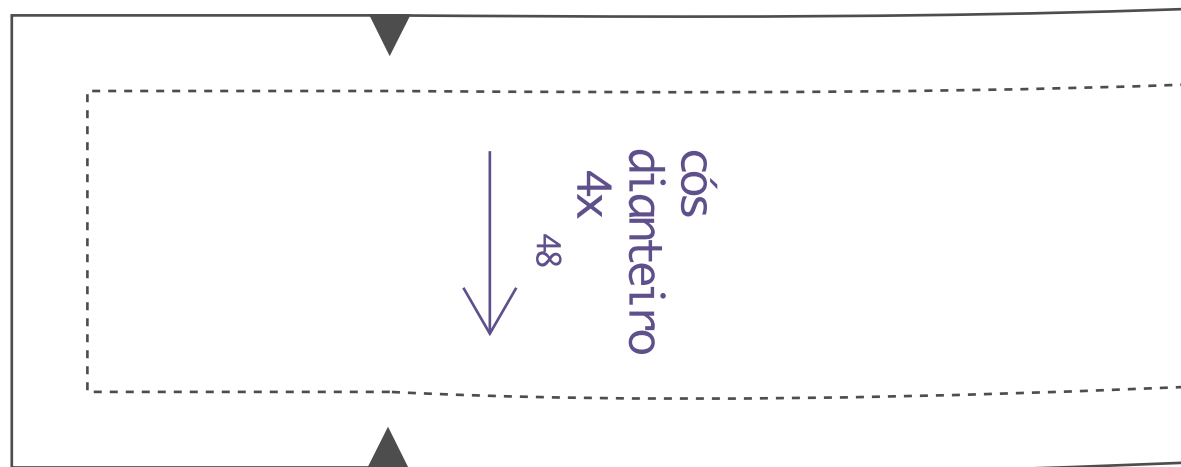



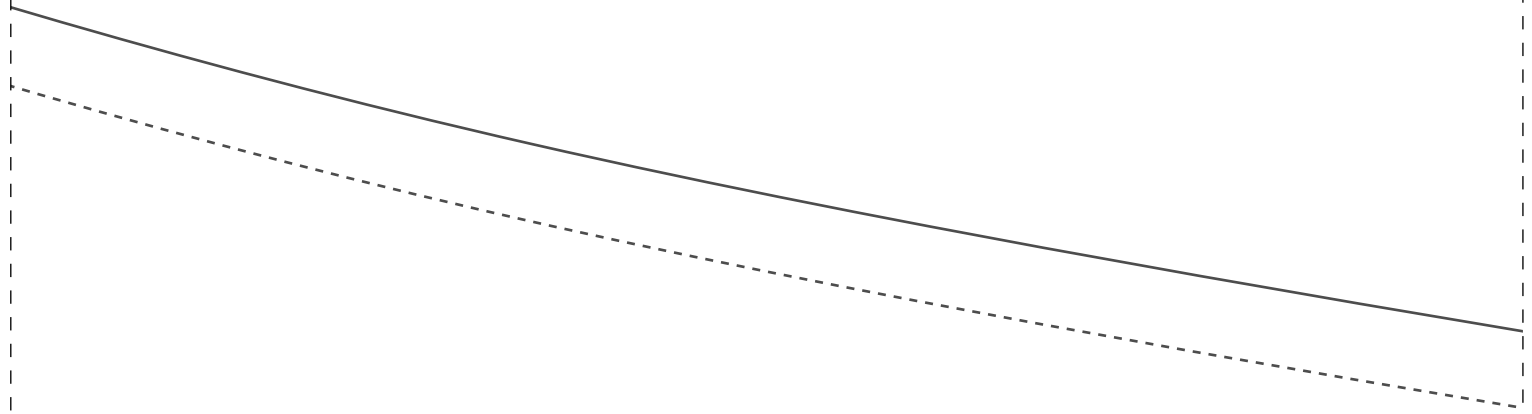

dianteiro 2x

48



chi

taria



**IDDED CD33**



IDDED CD33

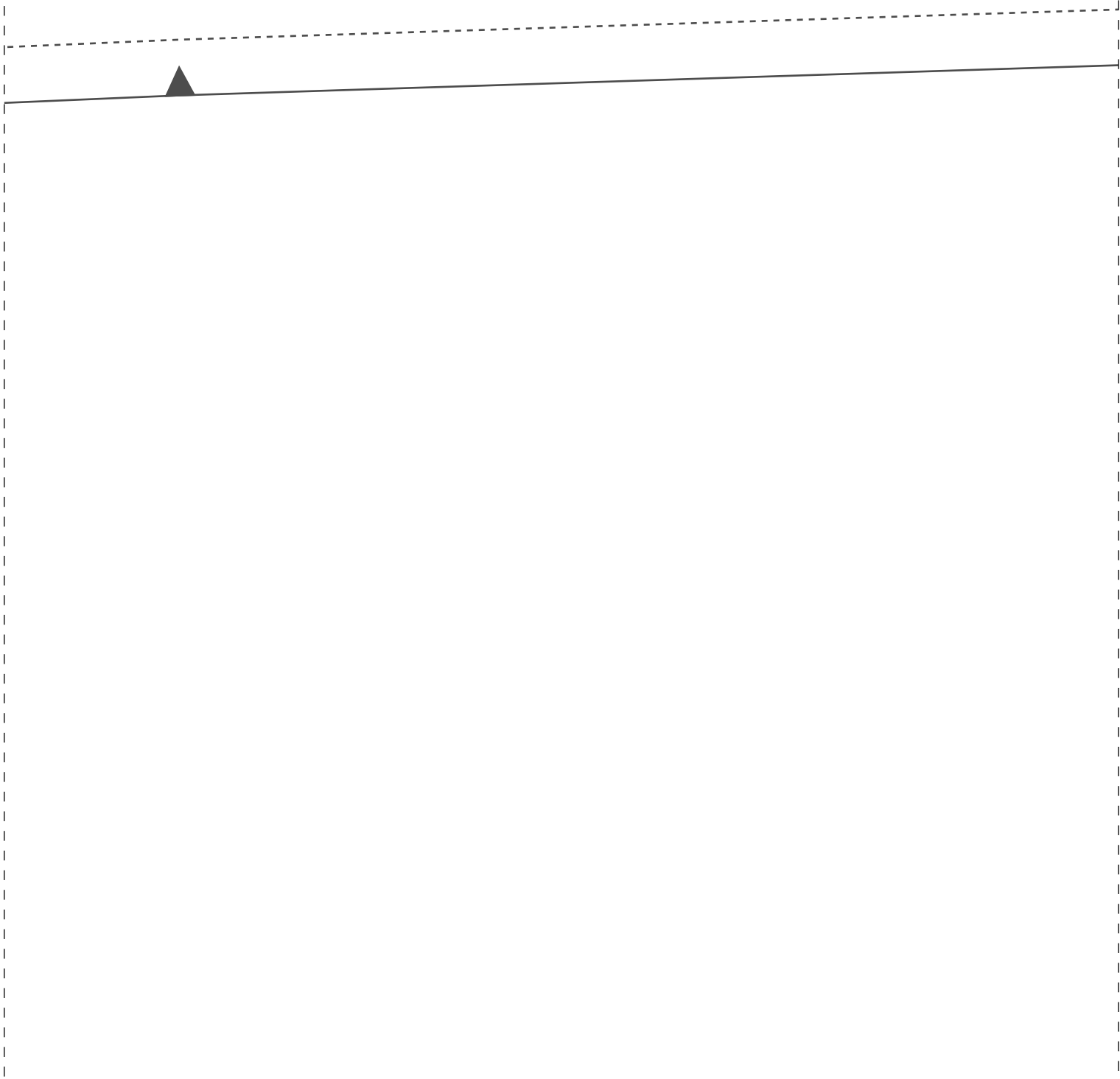

1-11



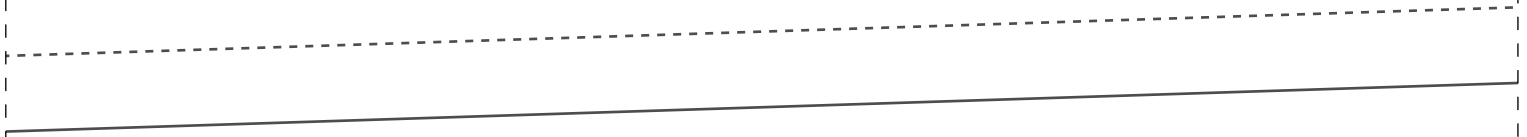

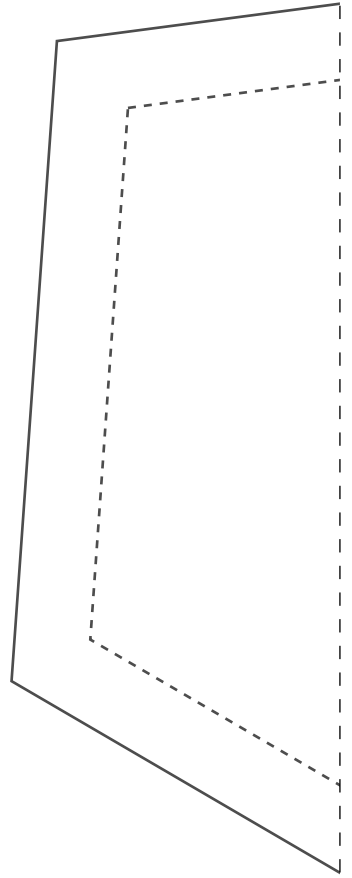
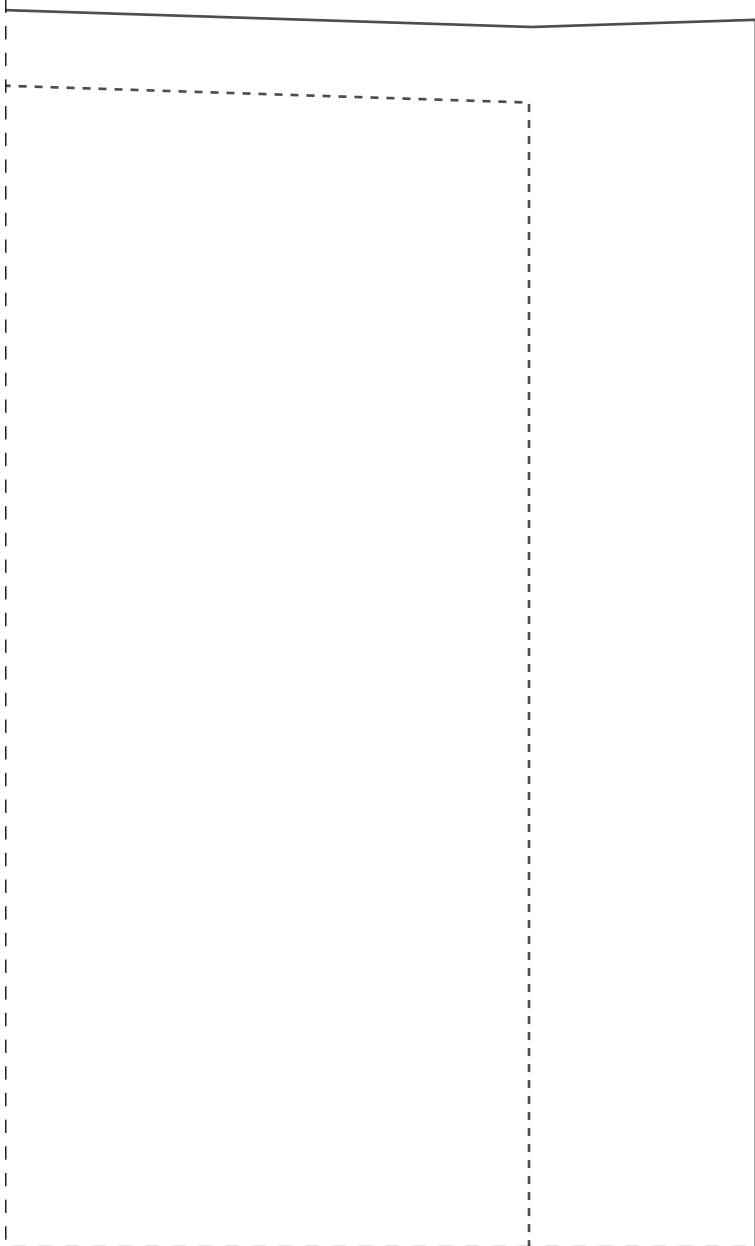

2-12

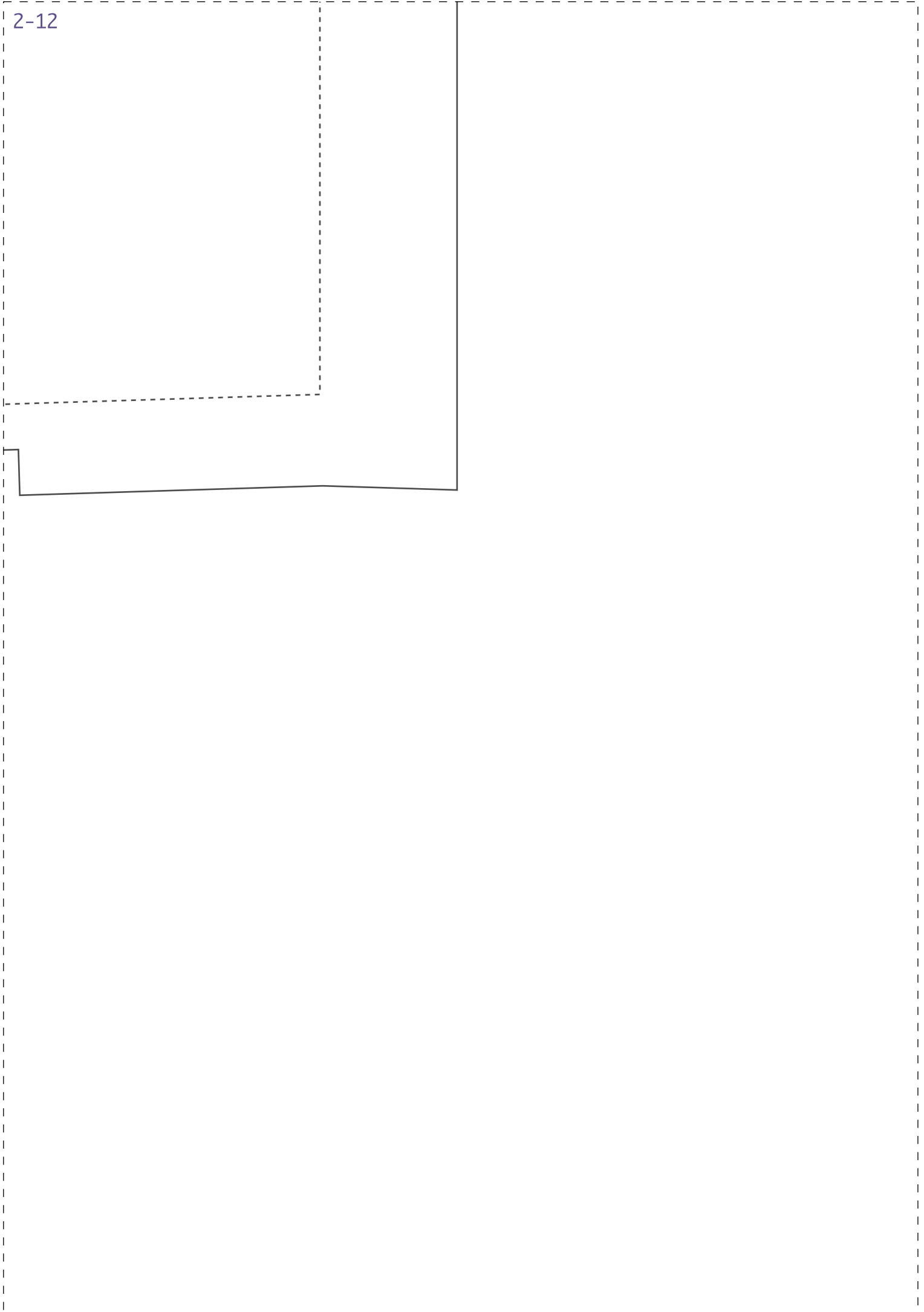



1-13

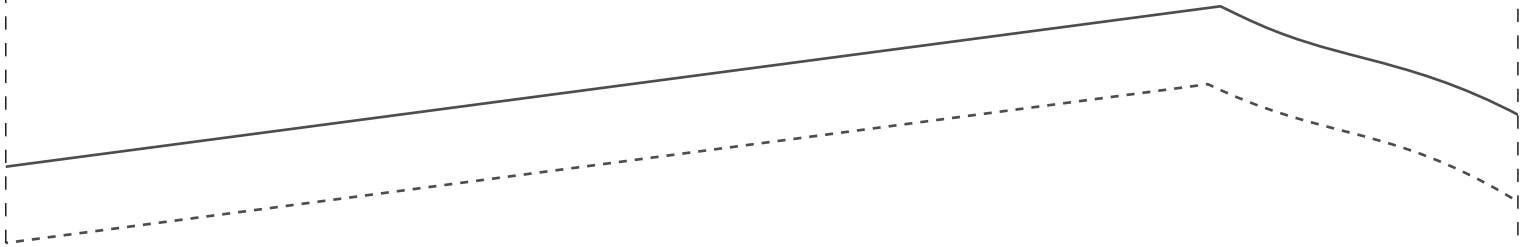

bolso 2x  
48



IDDED CD33

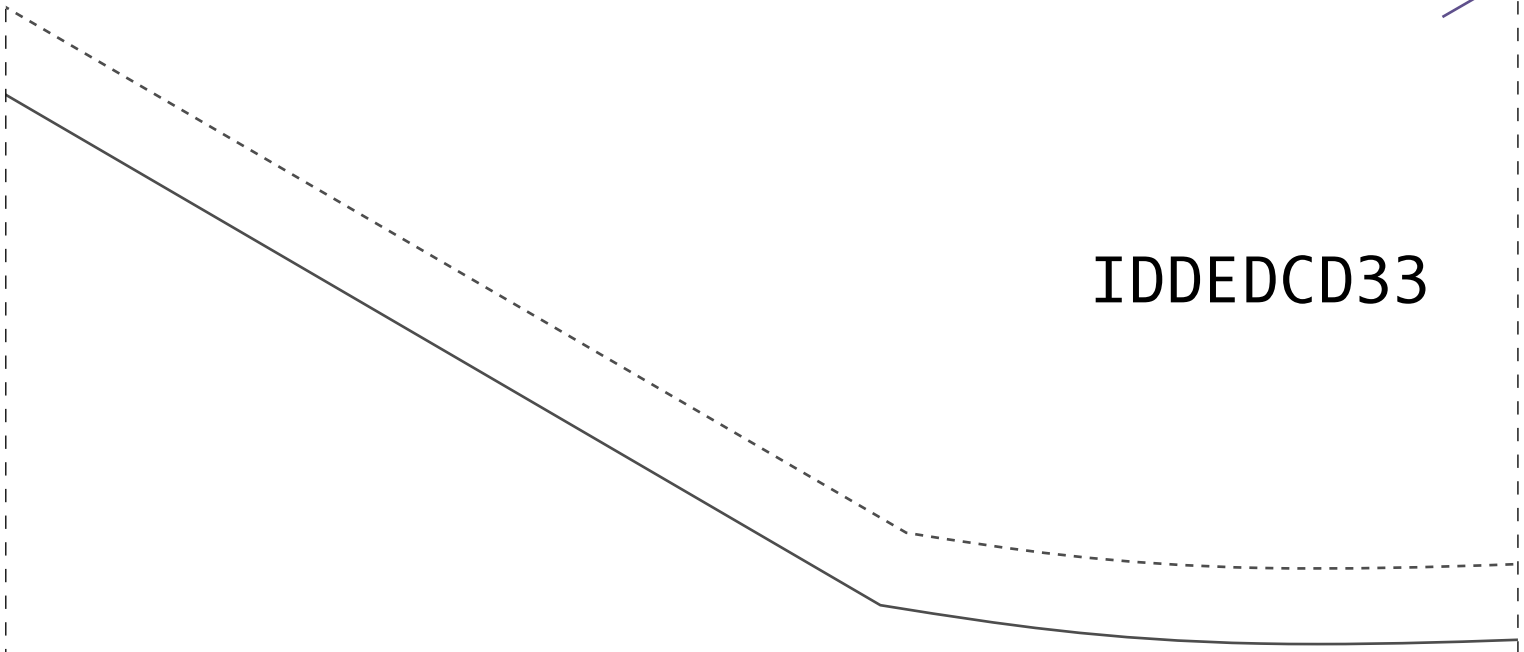

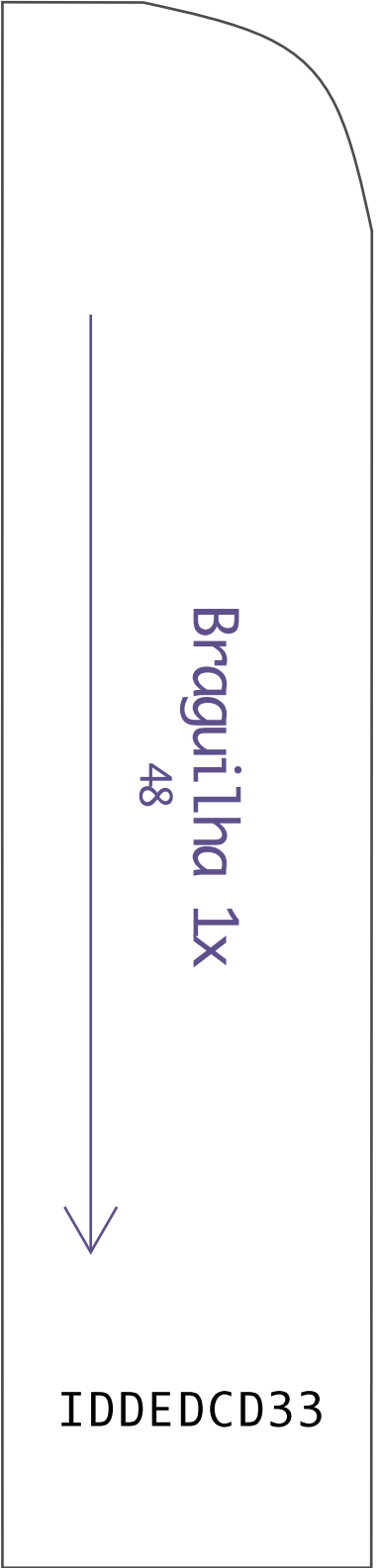

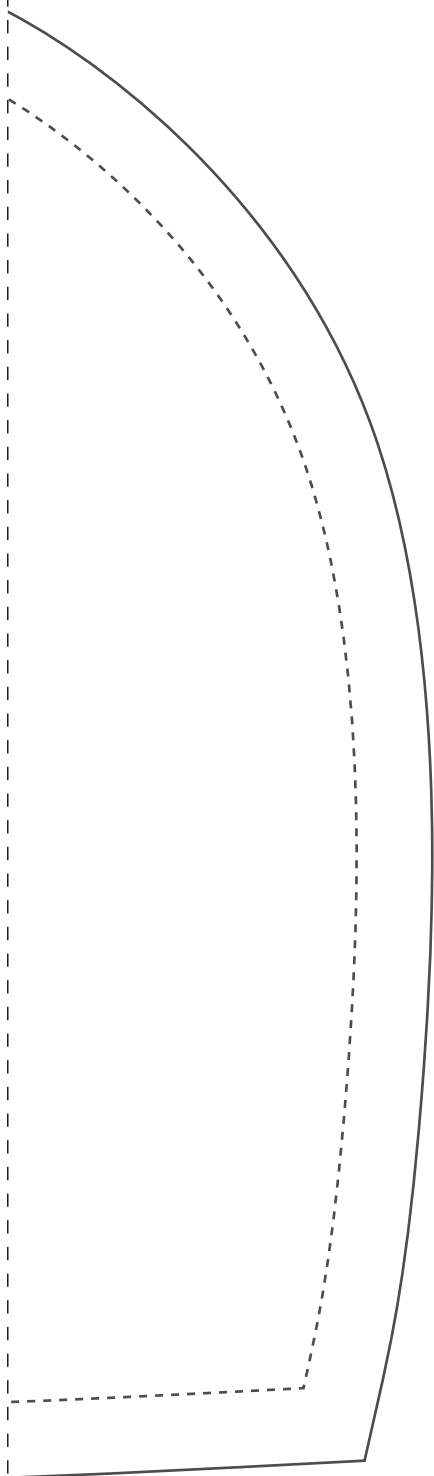

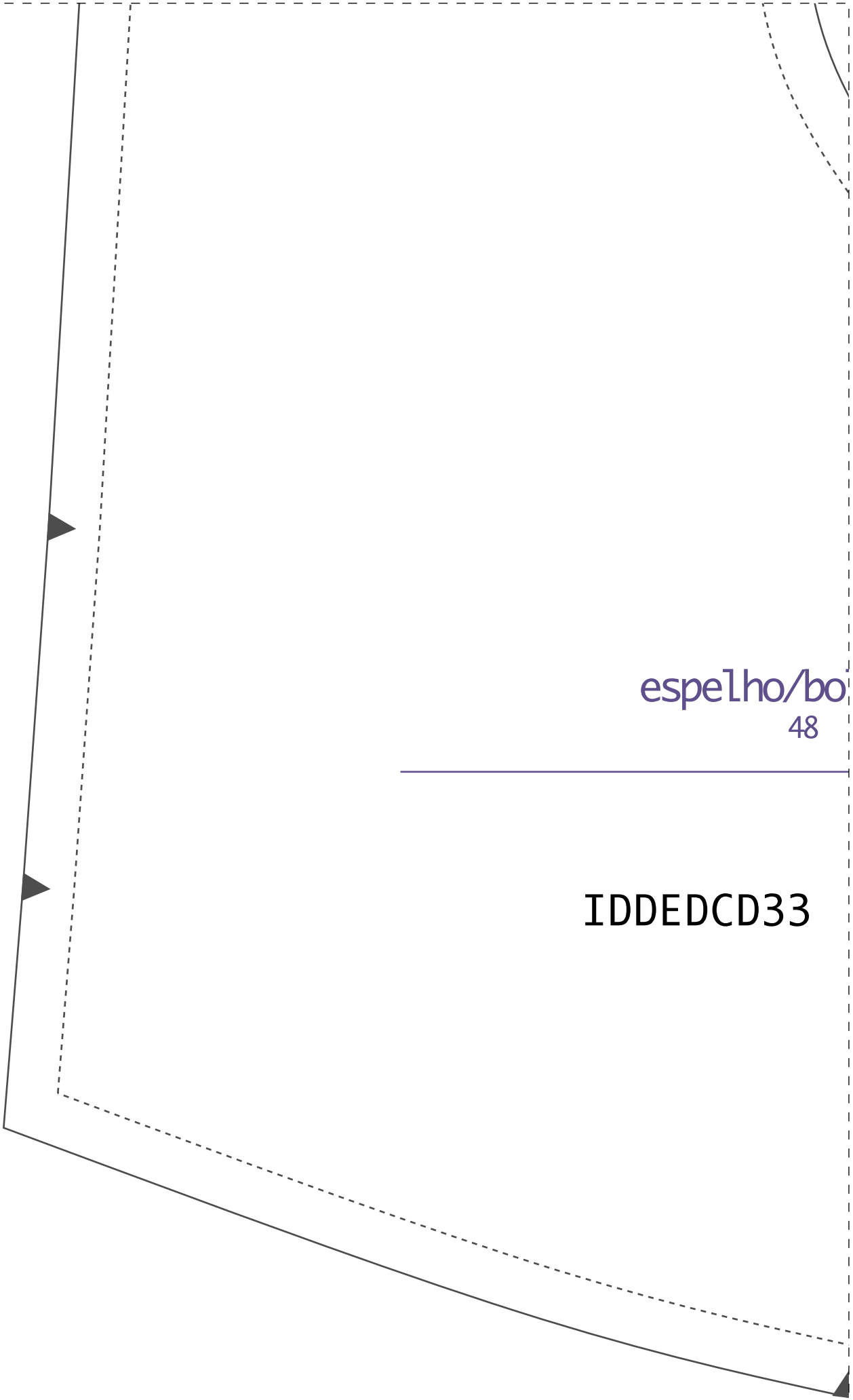

espelho/bo  
48

IDDED33



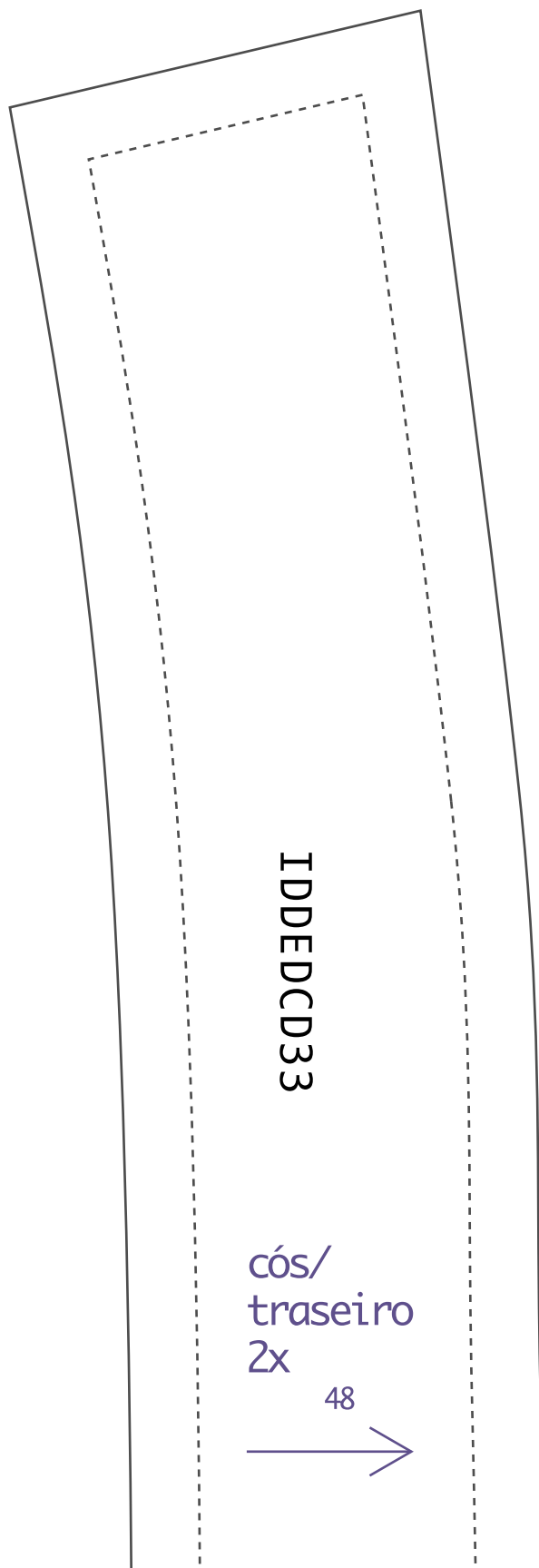

IDDEDCCD33

cós/  
traseiro  
2x

48



2-15

dobra

Iso 2x

