

Teste de impressão: ao imprimir seu molde, meça o quadrado que deverá ter a mesma medida informada (4cm), assim você se certificará que ele foi impresso no tamanho correto.

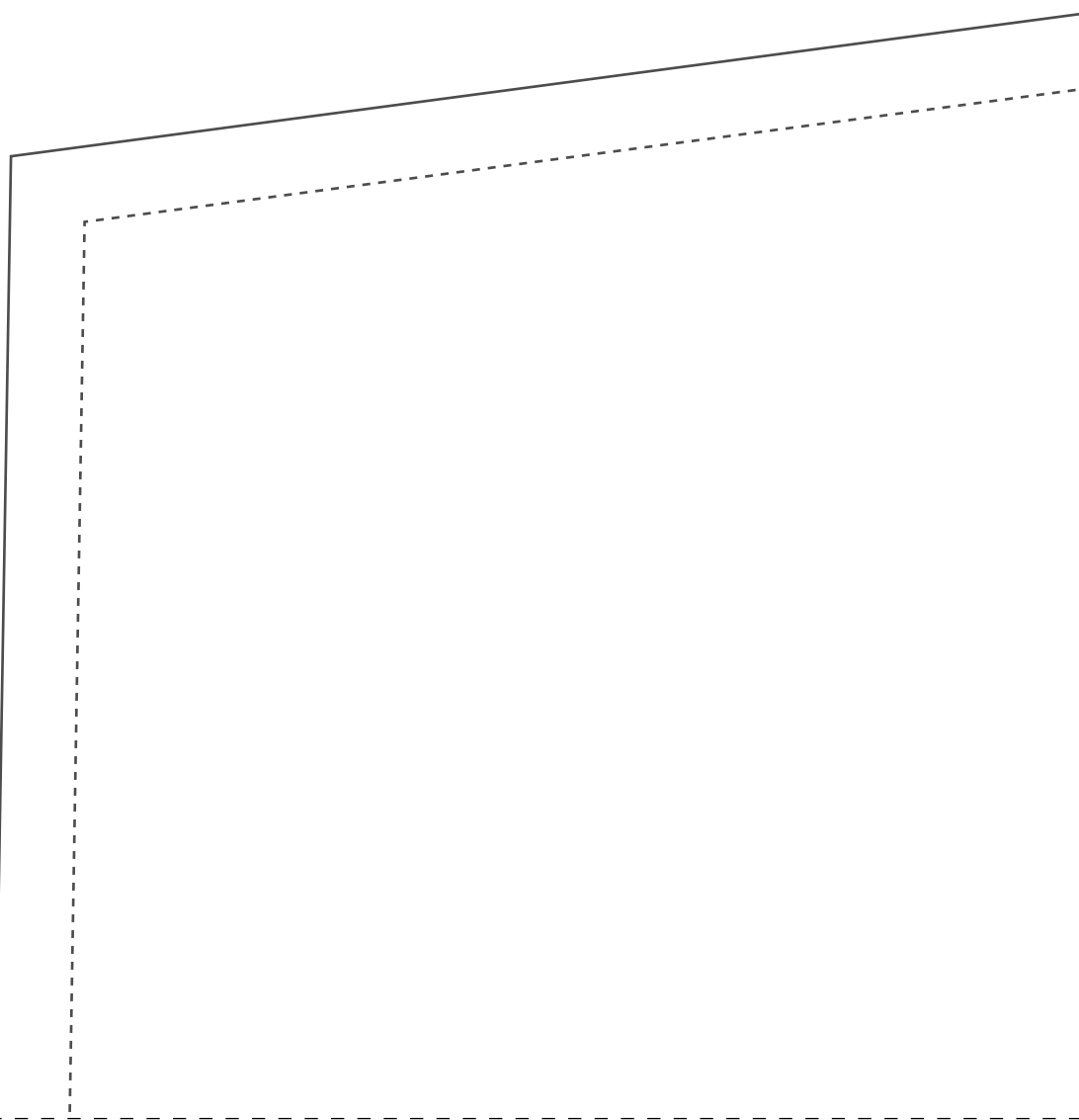

2-1

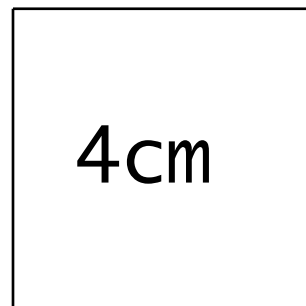
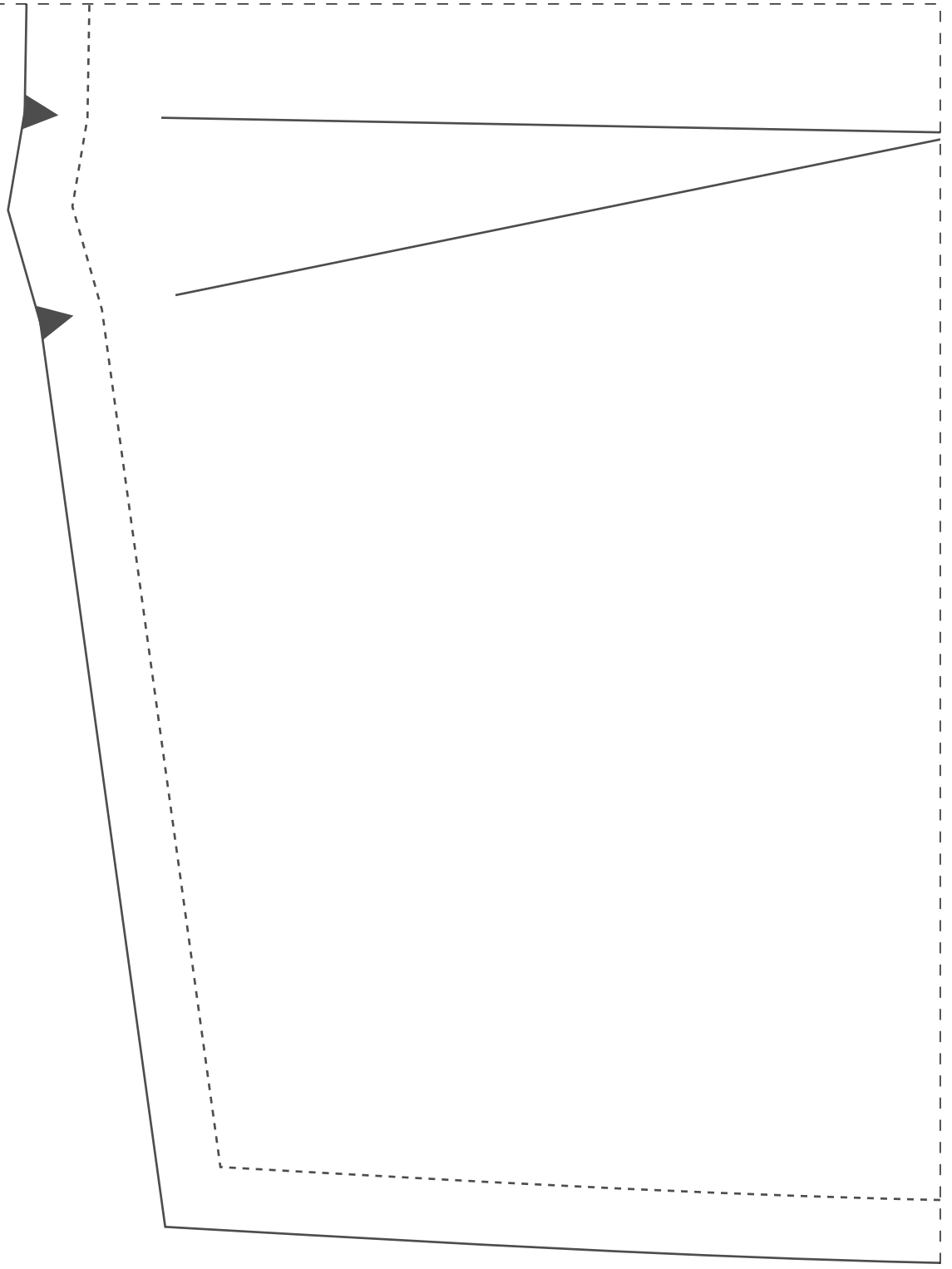

1-2

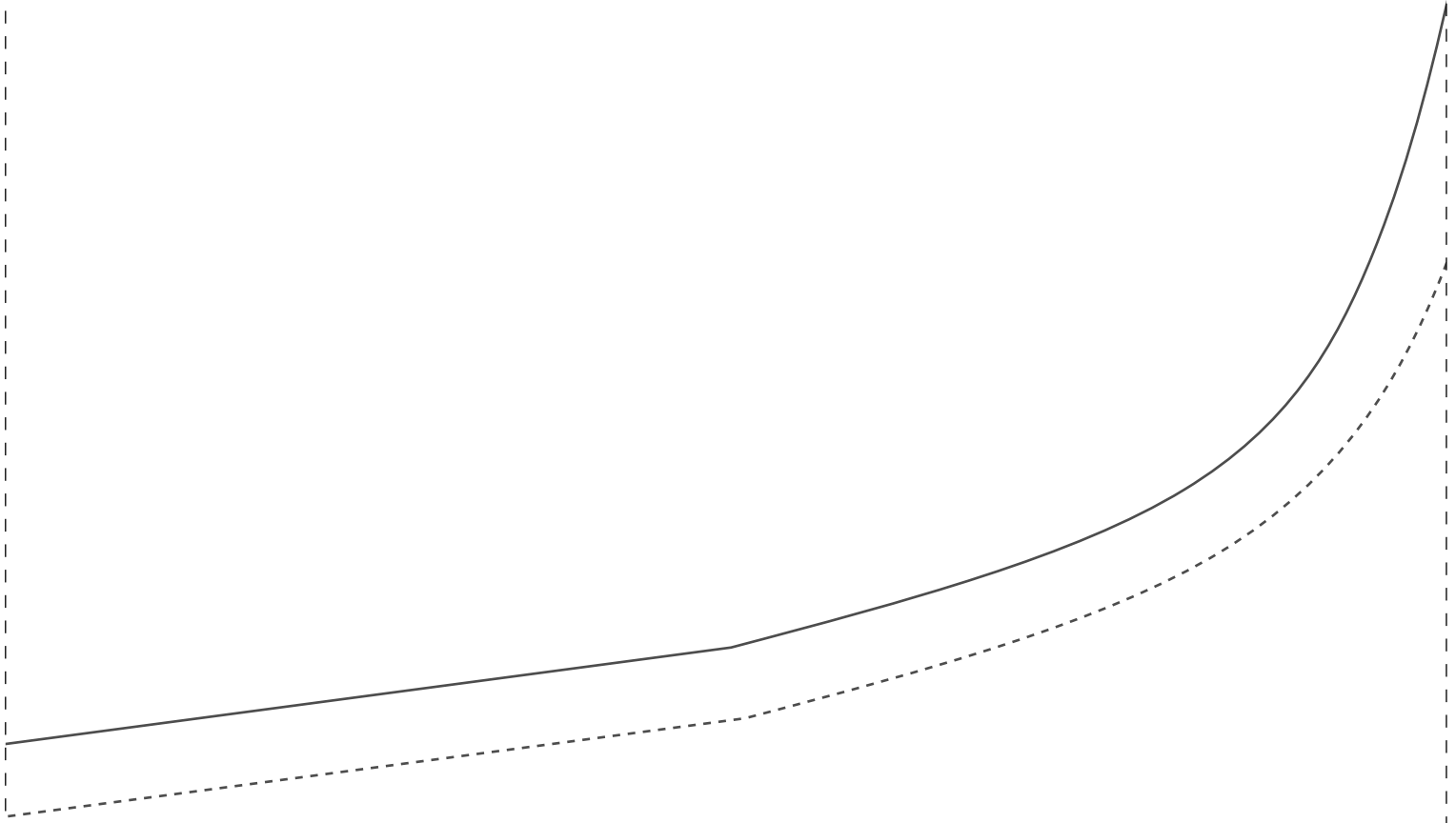



1-3

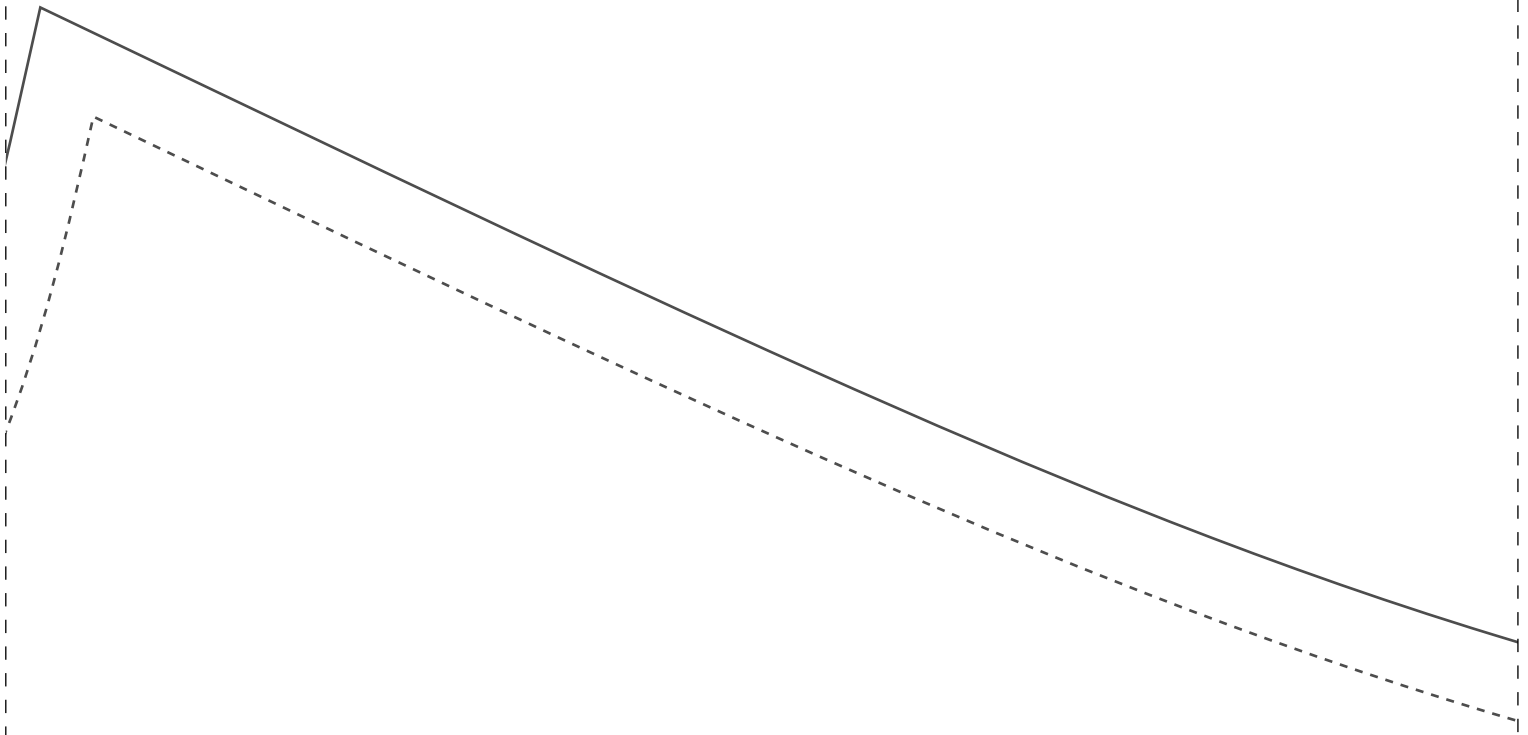

trace

Ficha Técnica:

- Tecido Plano 1,4m de largura
- Linho, gabardine, alfaiataria ou similares
- Bolso faca
- Cós entretelado (opcional)
- 1,6m para os tamanhos 36 ao 42
- 2m para os tamanhos 44 ao 54
- 1 zíper comum 15cm

1-4

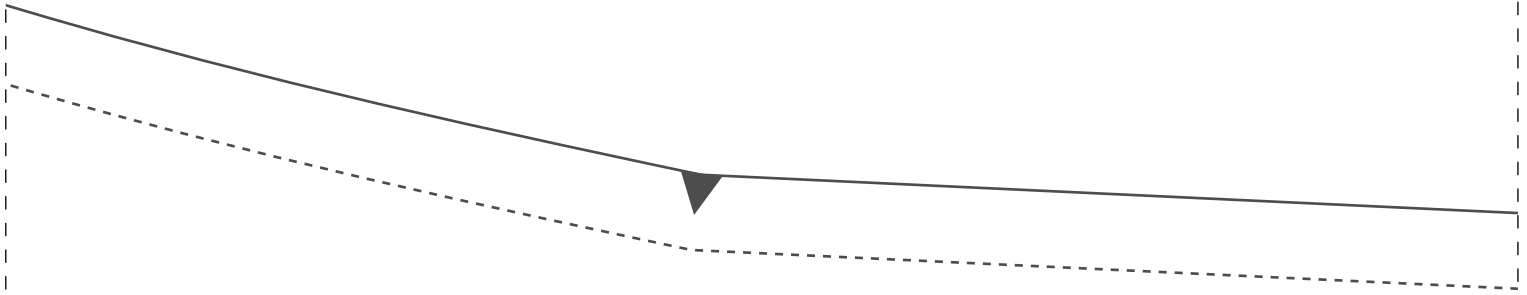

line 2x



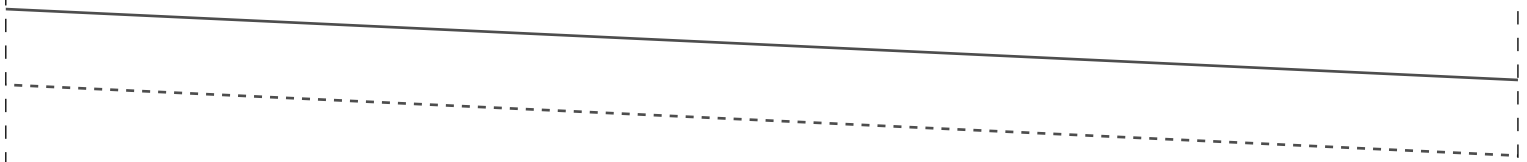

2-5



IDDED CD33

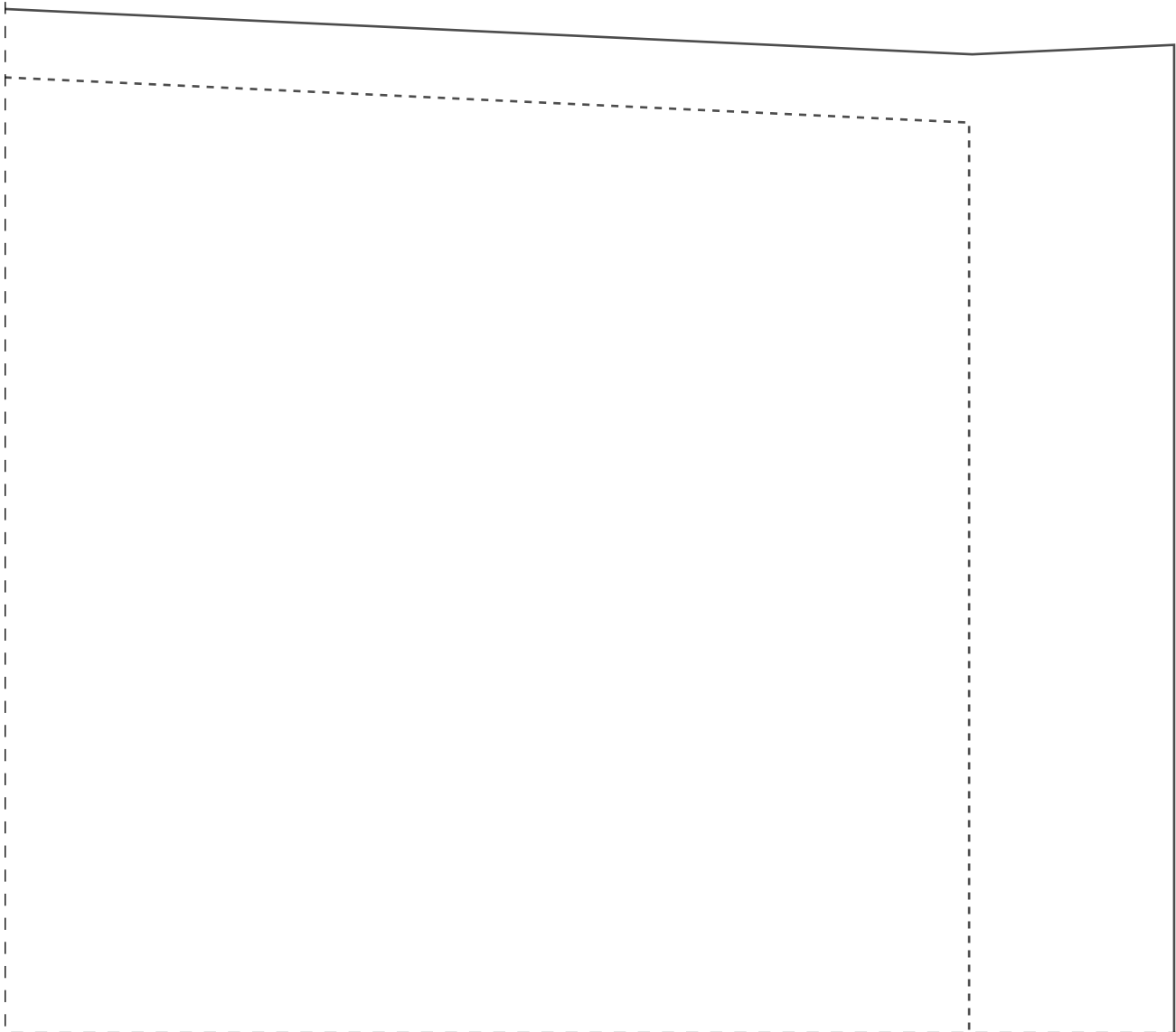

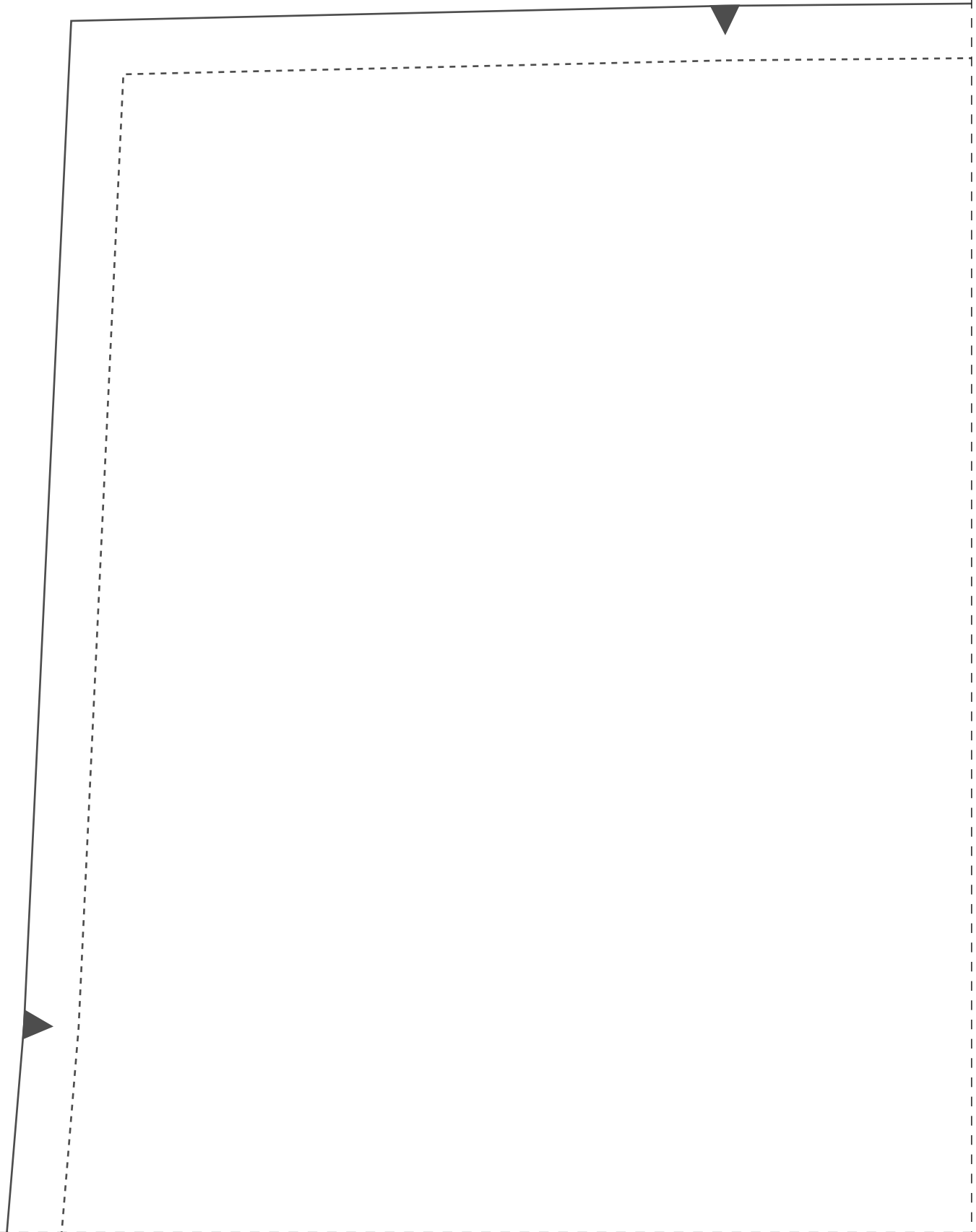

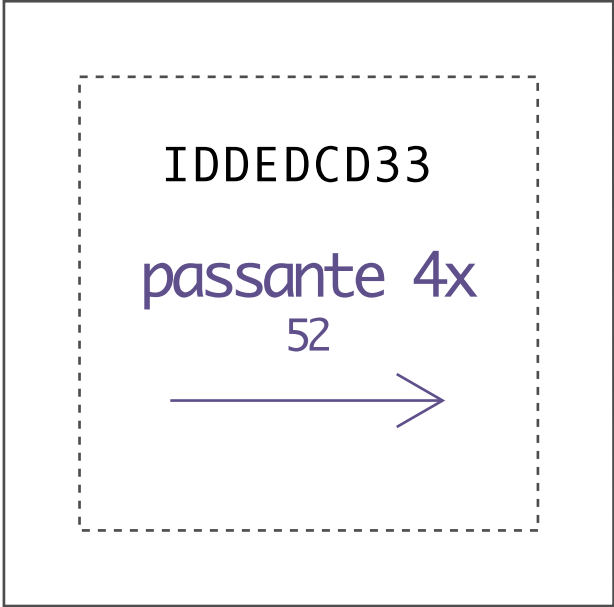
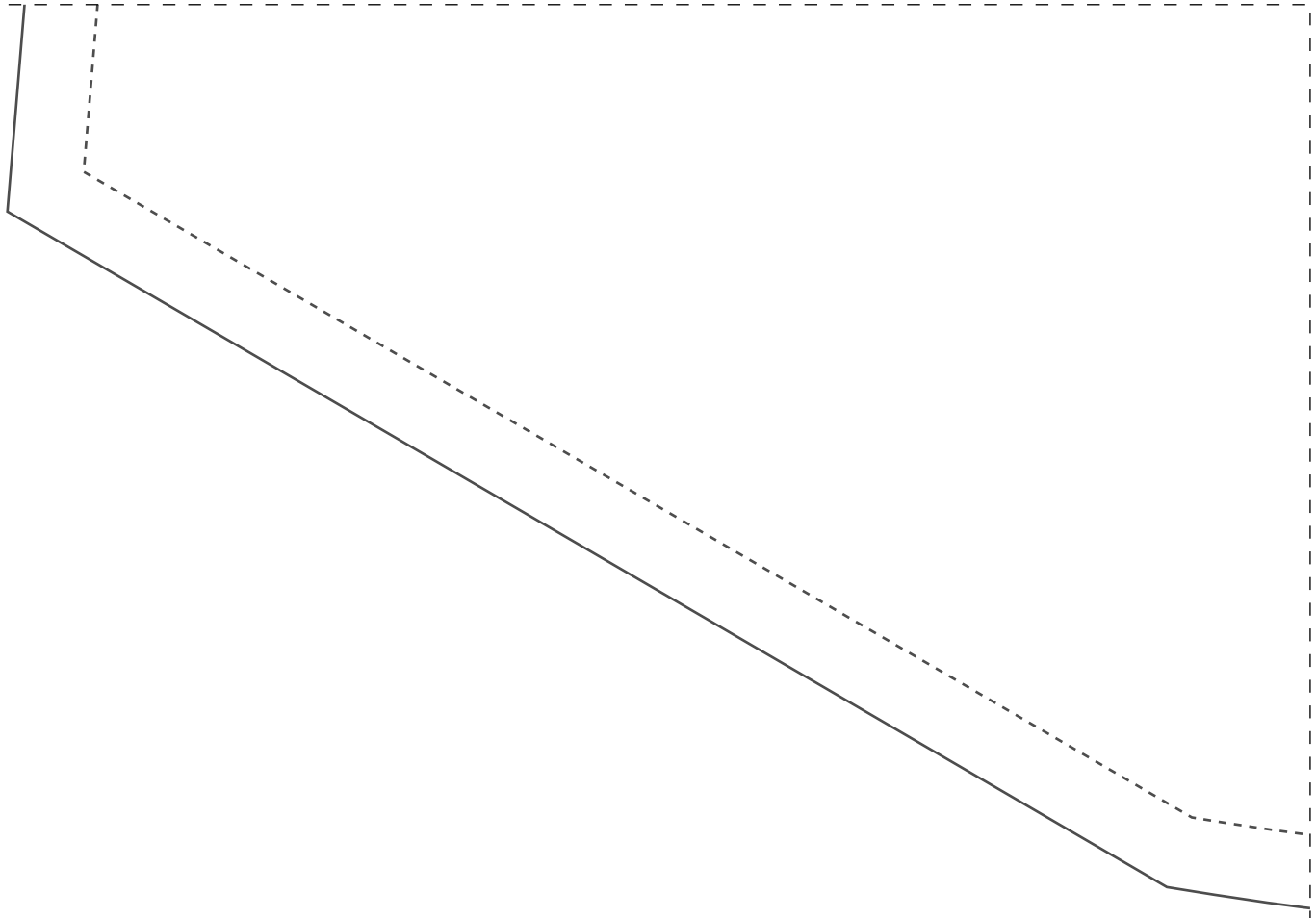

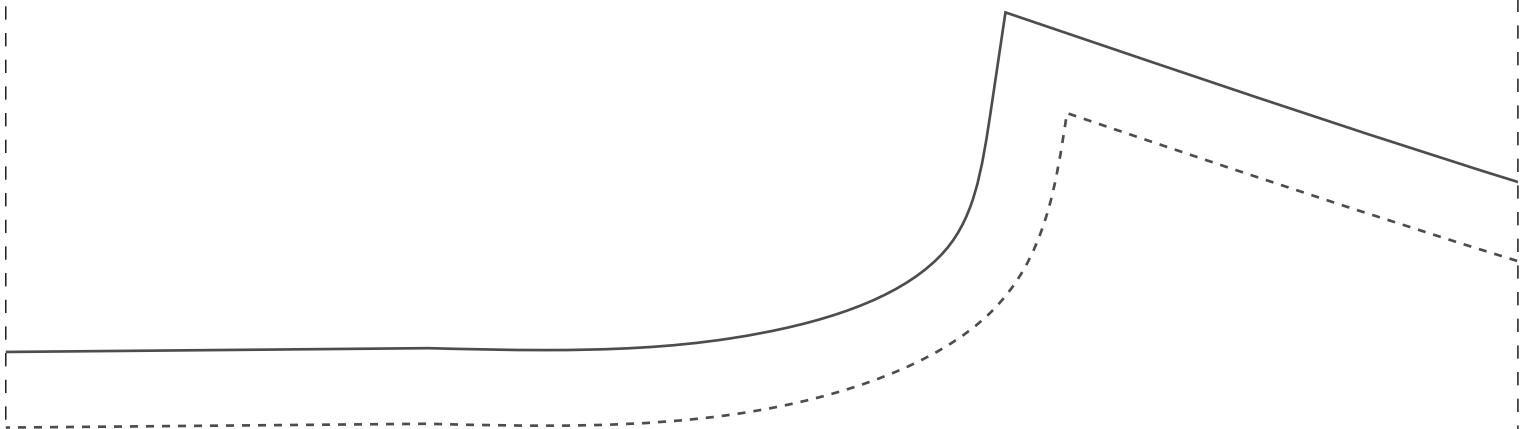

Instituto Diana Demar
Escola de Costurar
IDD Fashion Day
Calça Feminina Alfaia

PROIBIDA REVENDA

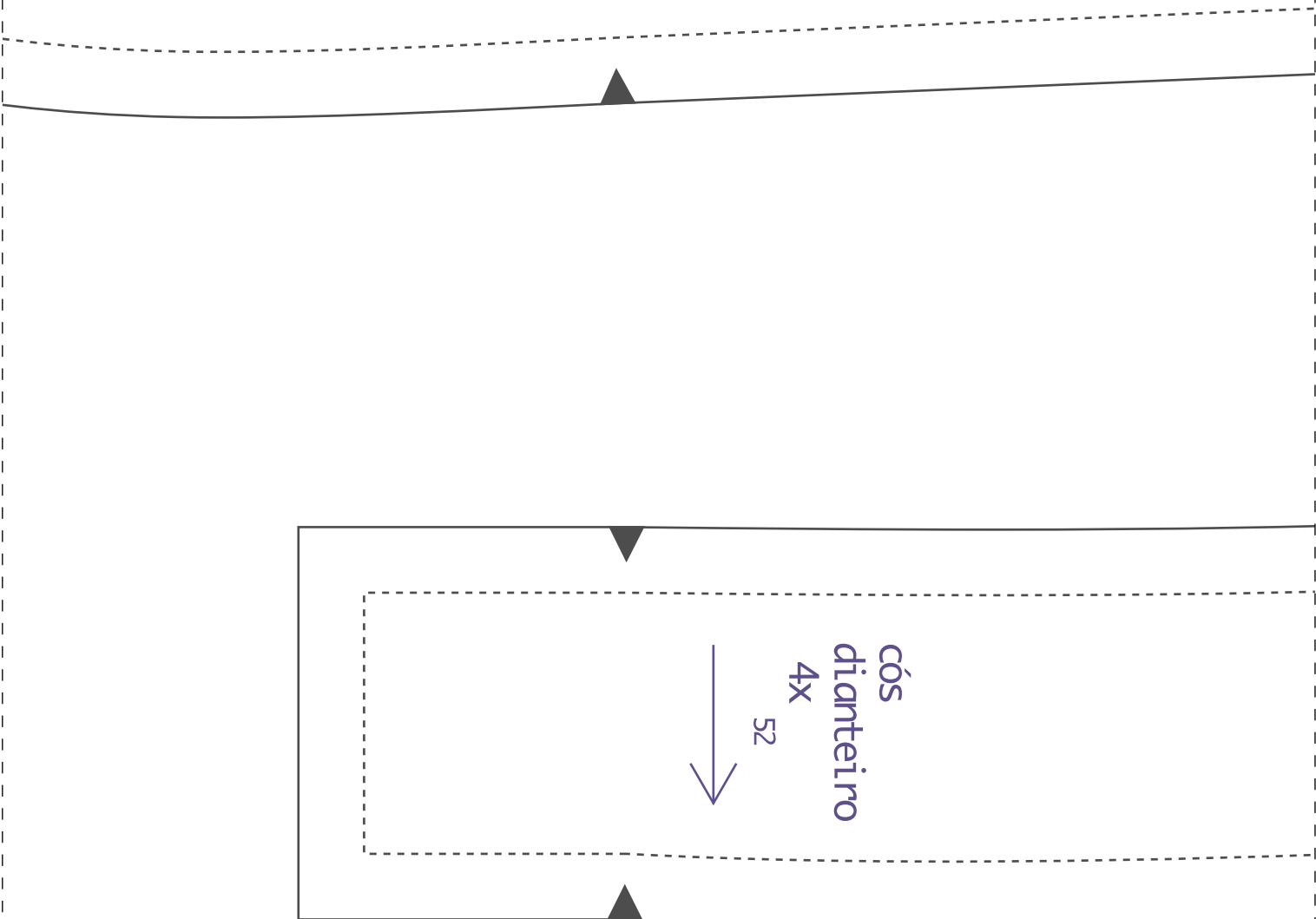

1-9

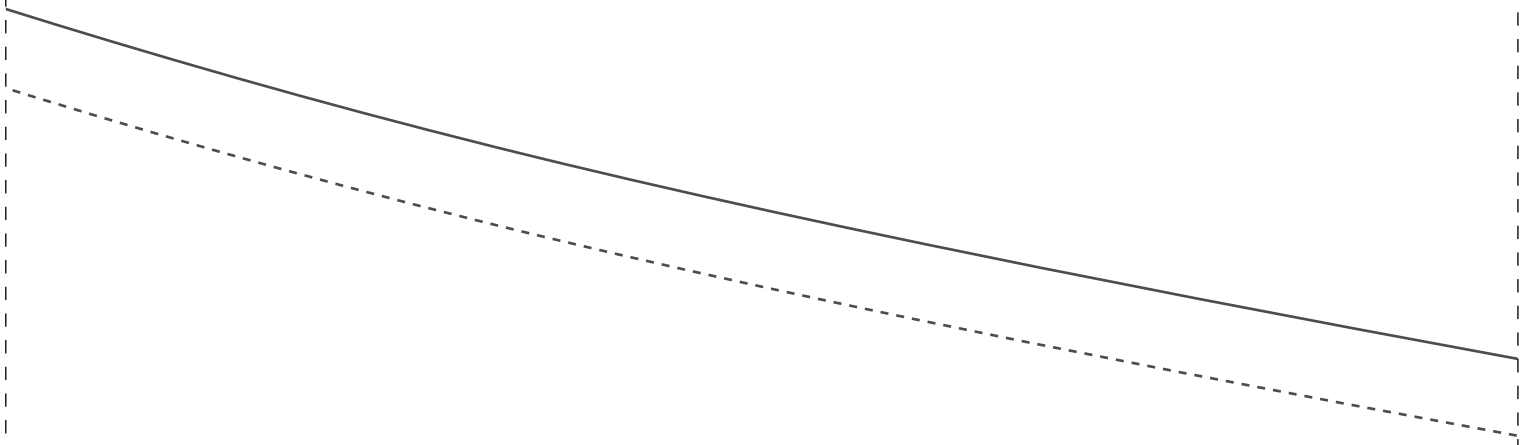

dianteiro 2x

52

2-9

chi

taria

IDDED CD33

1-10



IDDED CD33

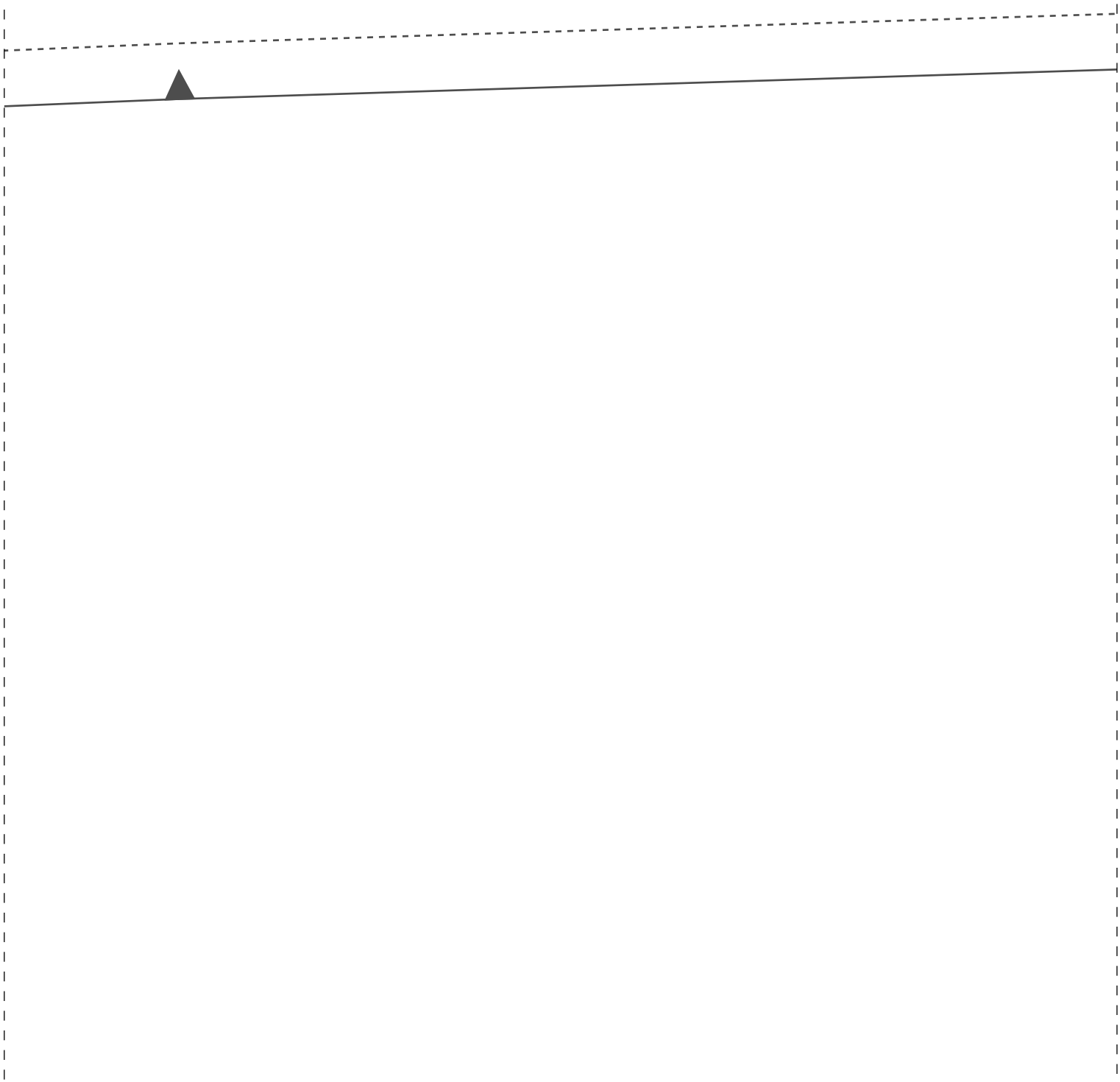

1-11

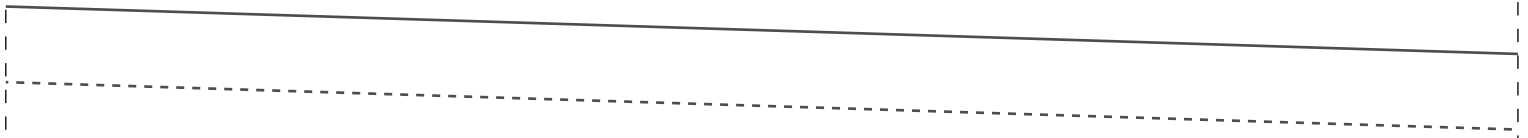

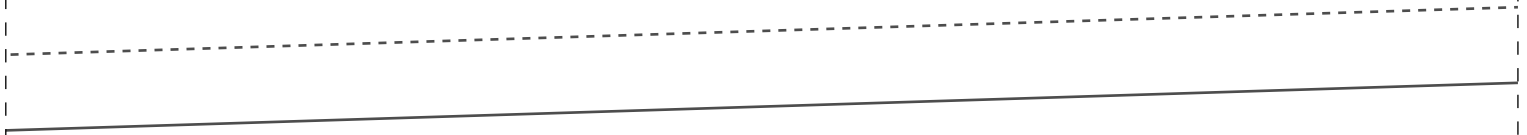

2-12

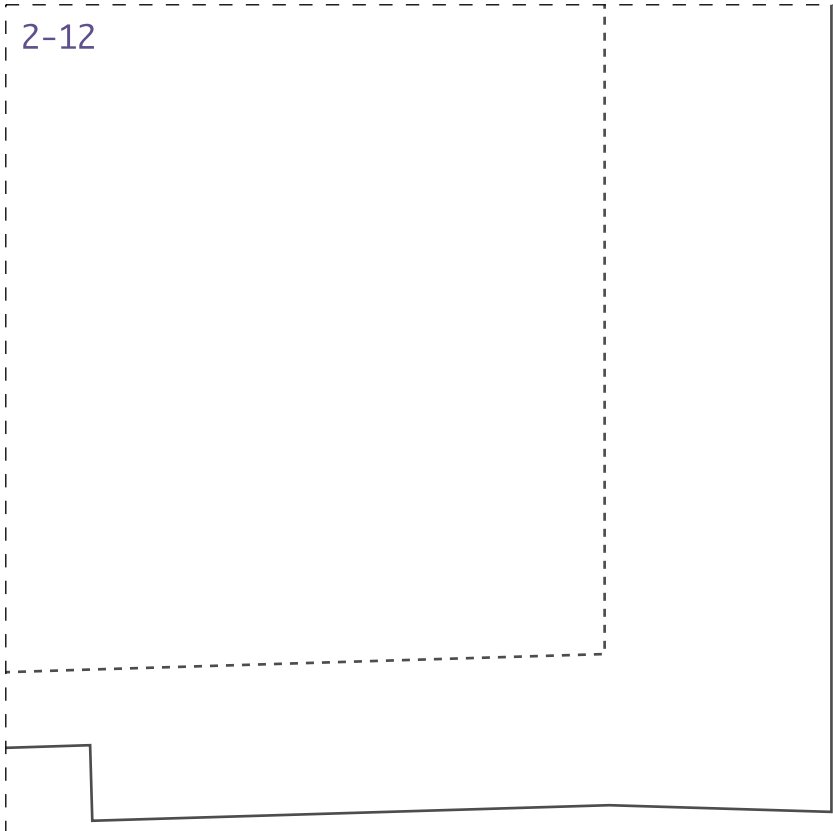
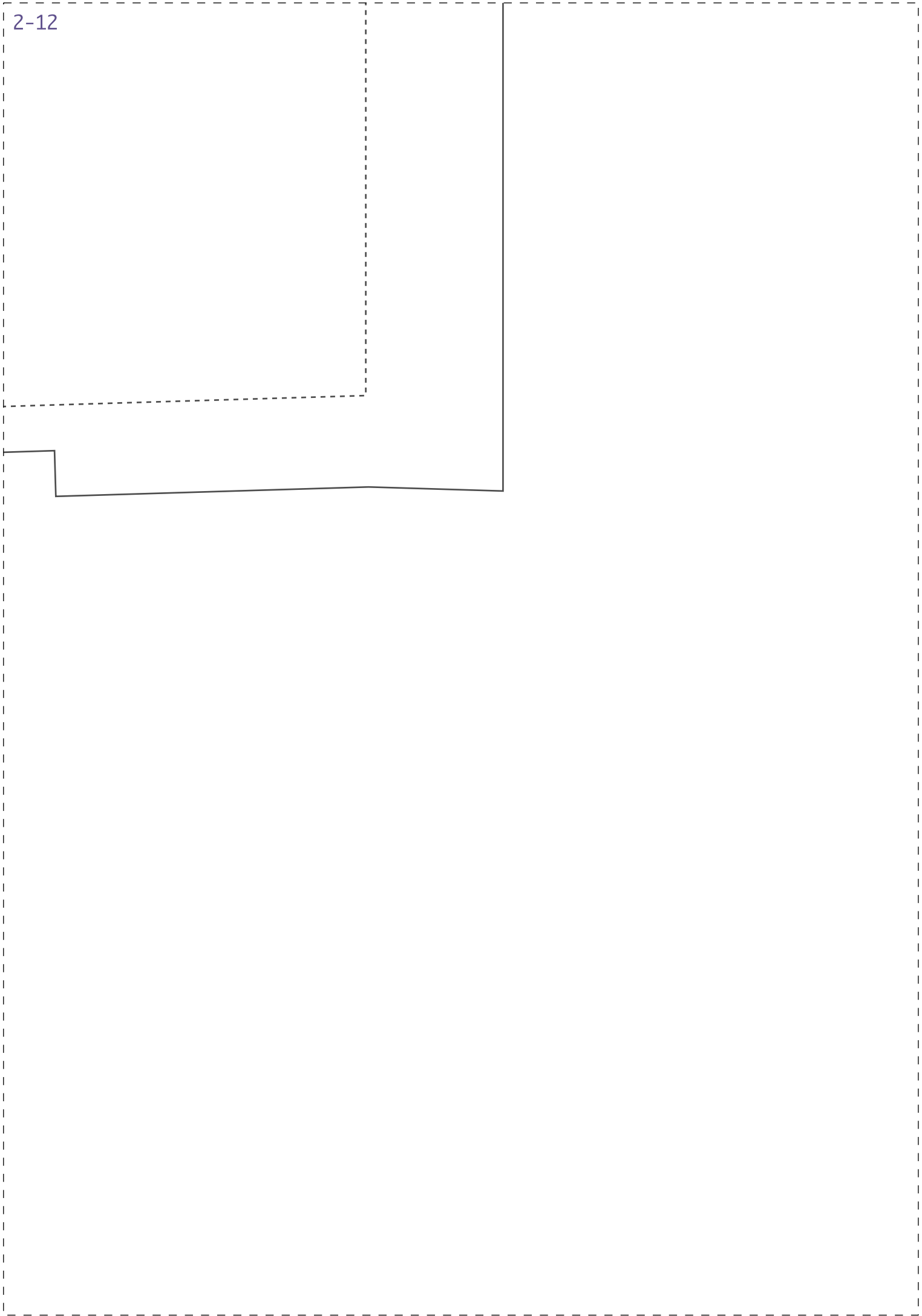

1-13

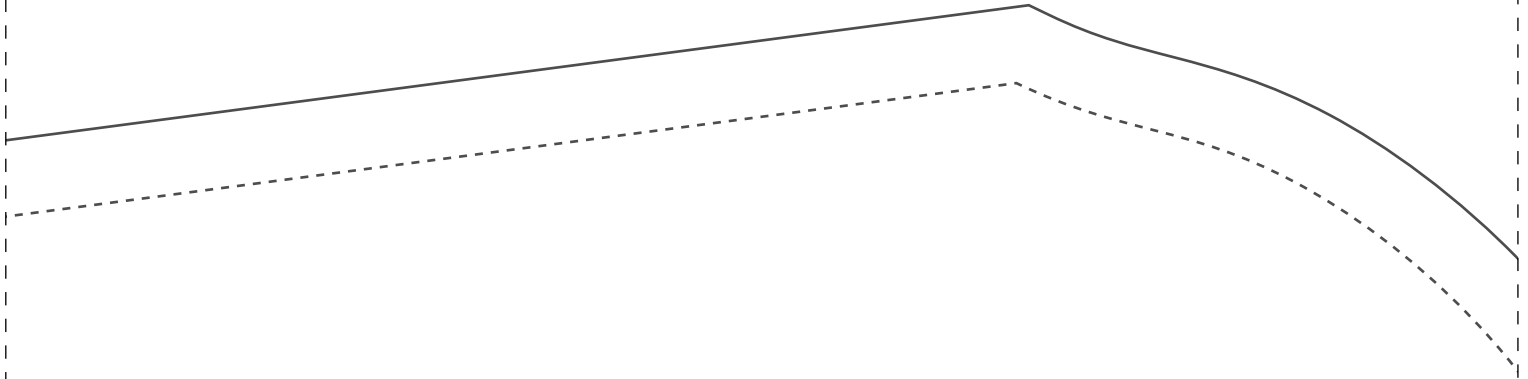

bolso 2x
52



IDDED CD33

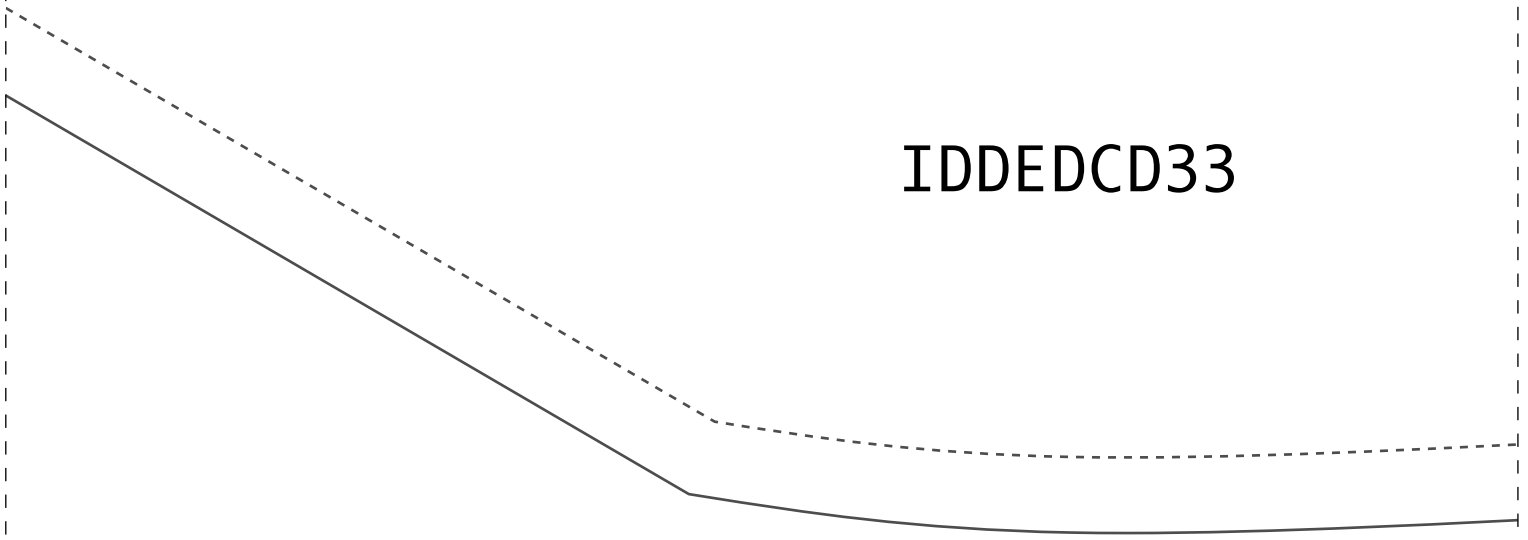



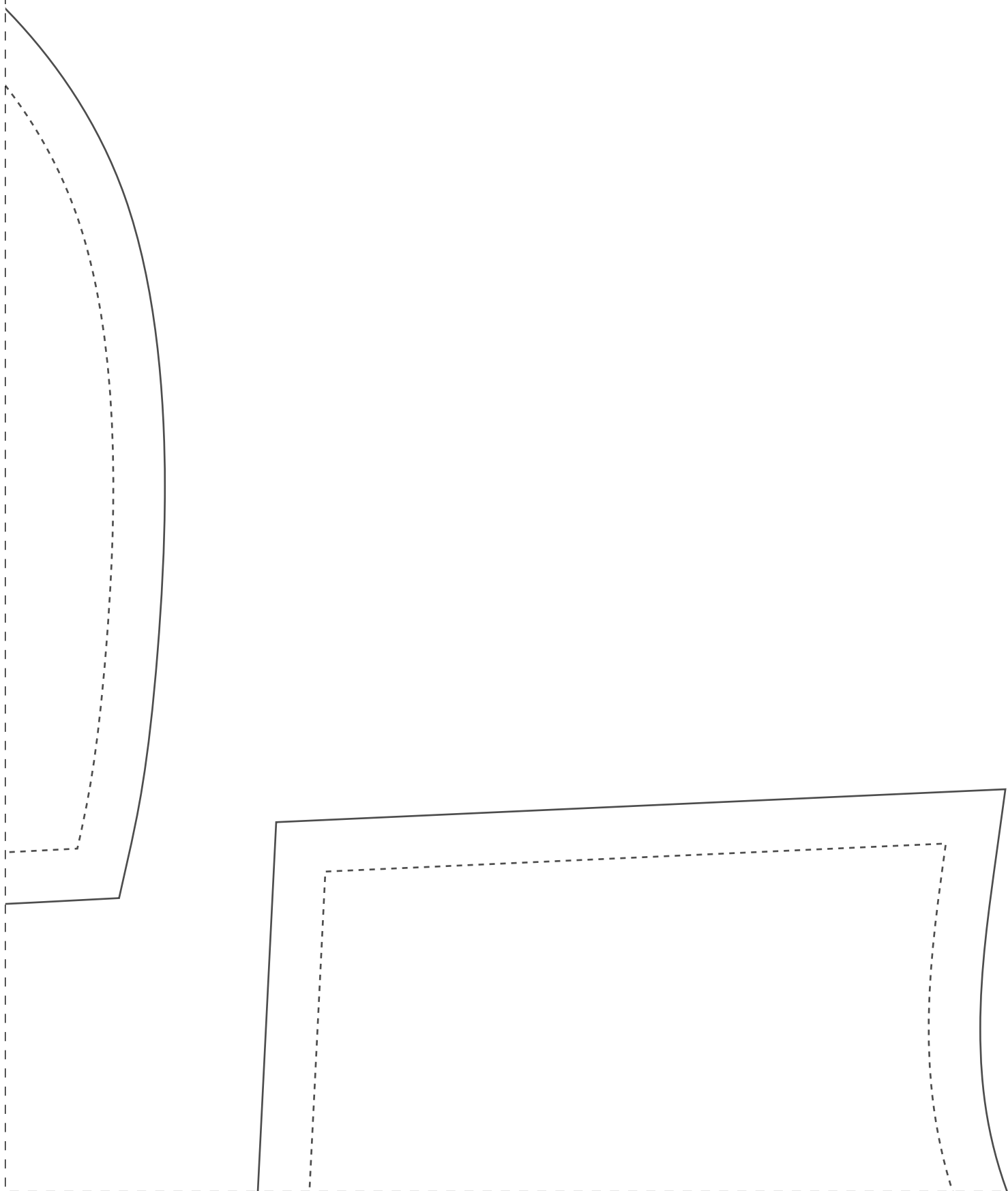

2-14

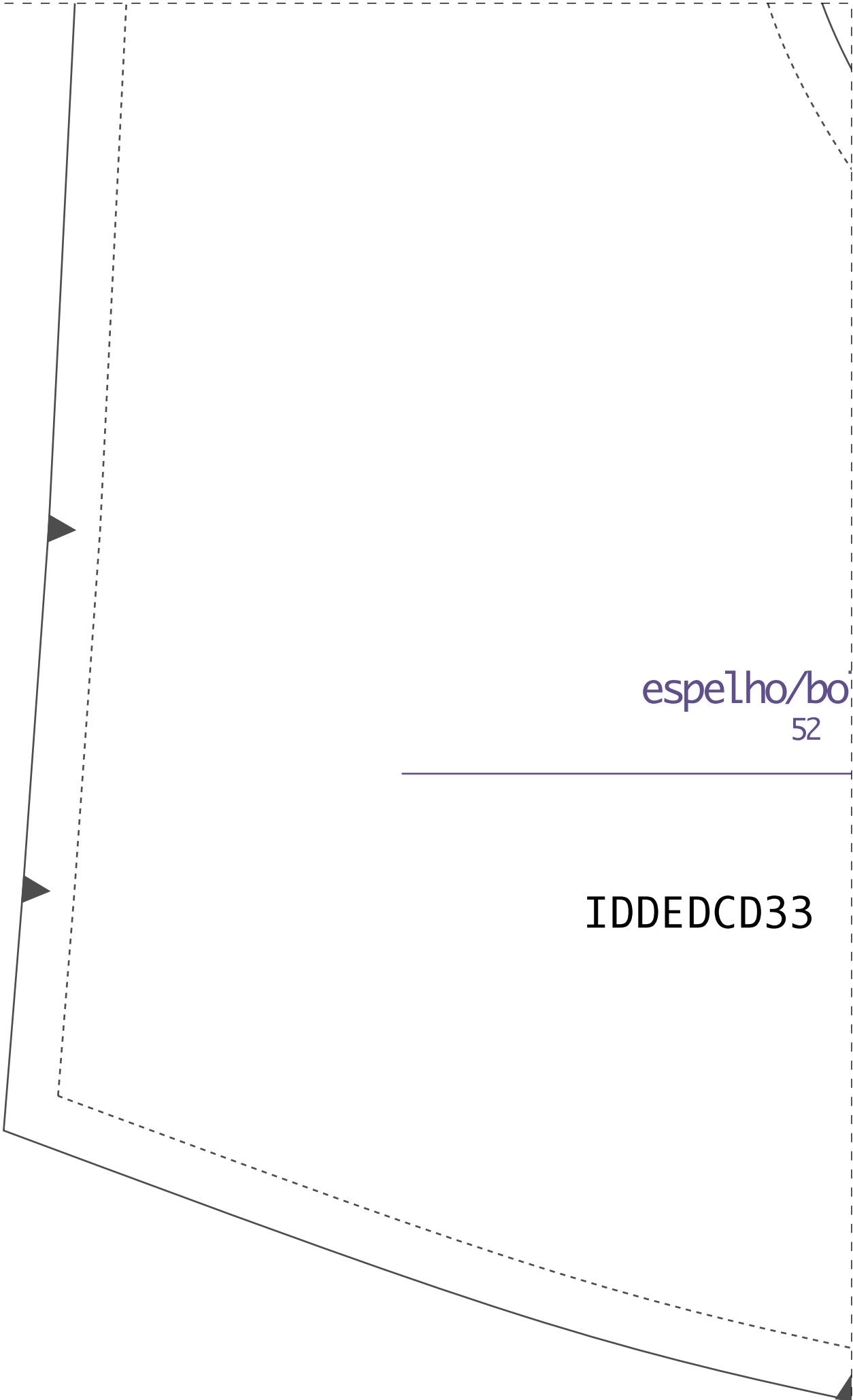

espelho/bo
52

IDDED CD33

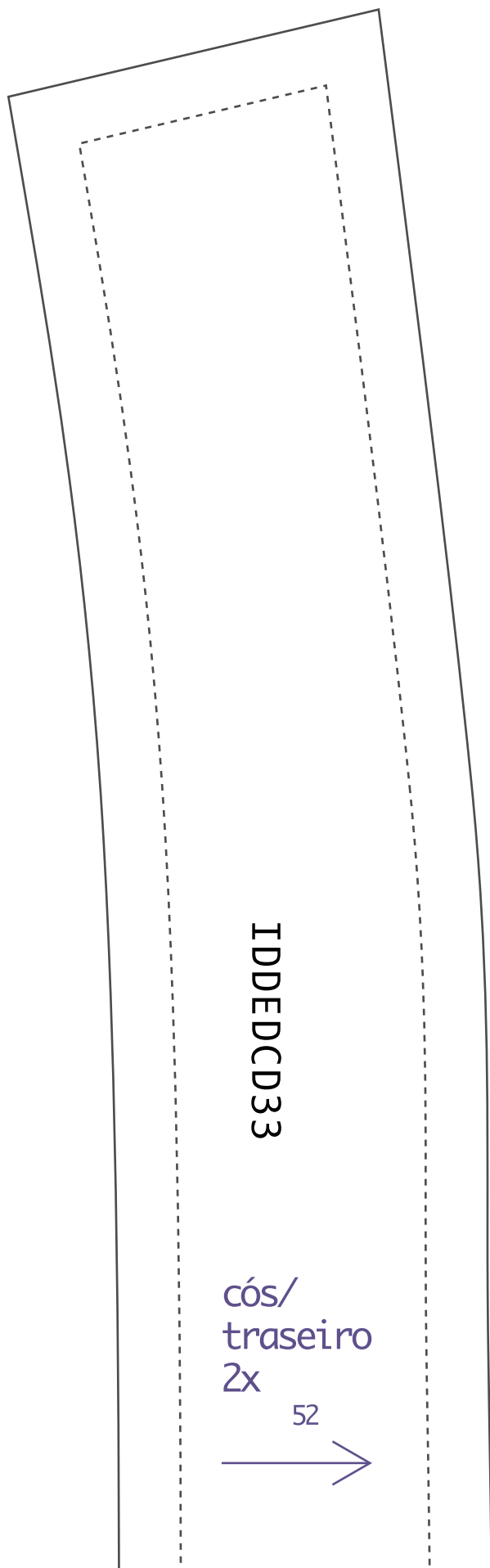

IDDEDCCD33

cós/
traseiro
2x

52



2-15

dobra

1so 2x

