

Teste de impressão: ao imprimir seu molde, meça o quadrado que deverá ter a mesma medida informada (4cm), assim você se certificará que ele foi impresso no tamanho correto.

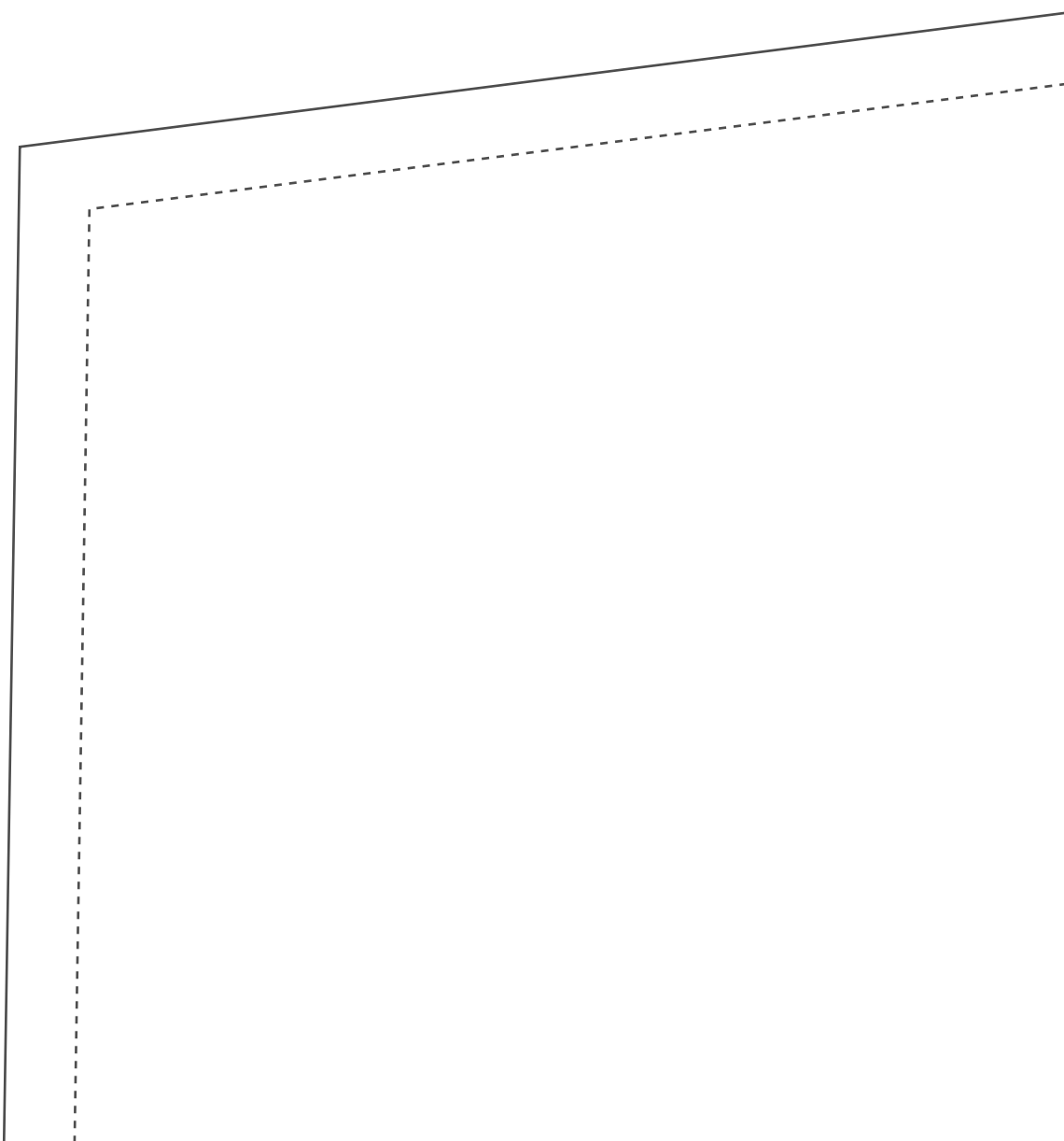

2-1

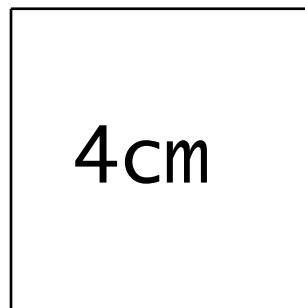
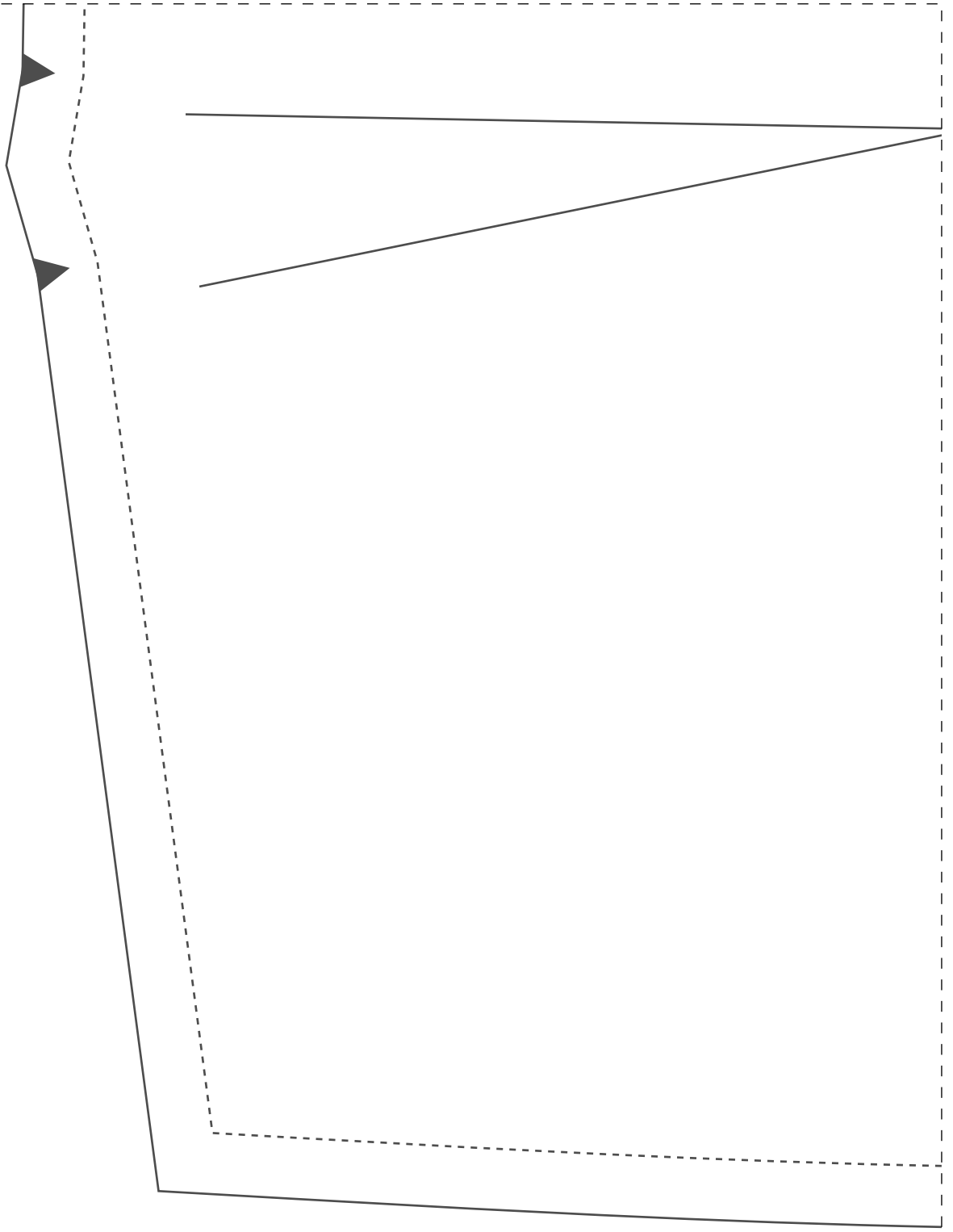

1-2

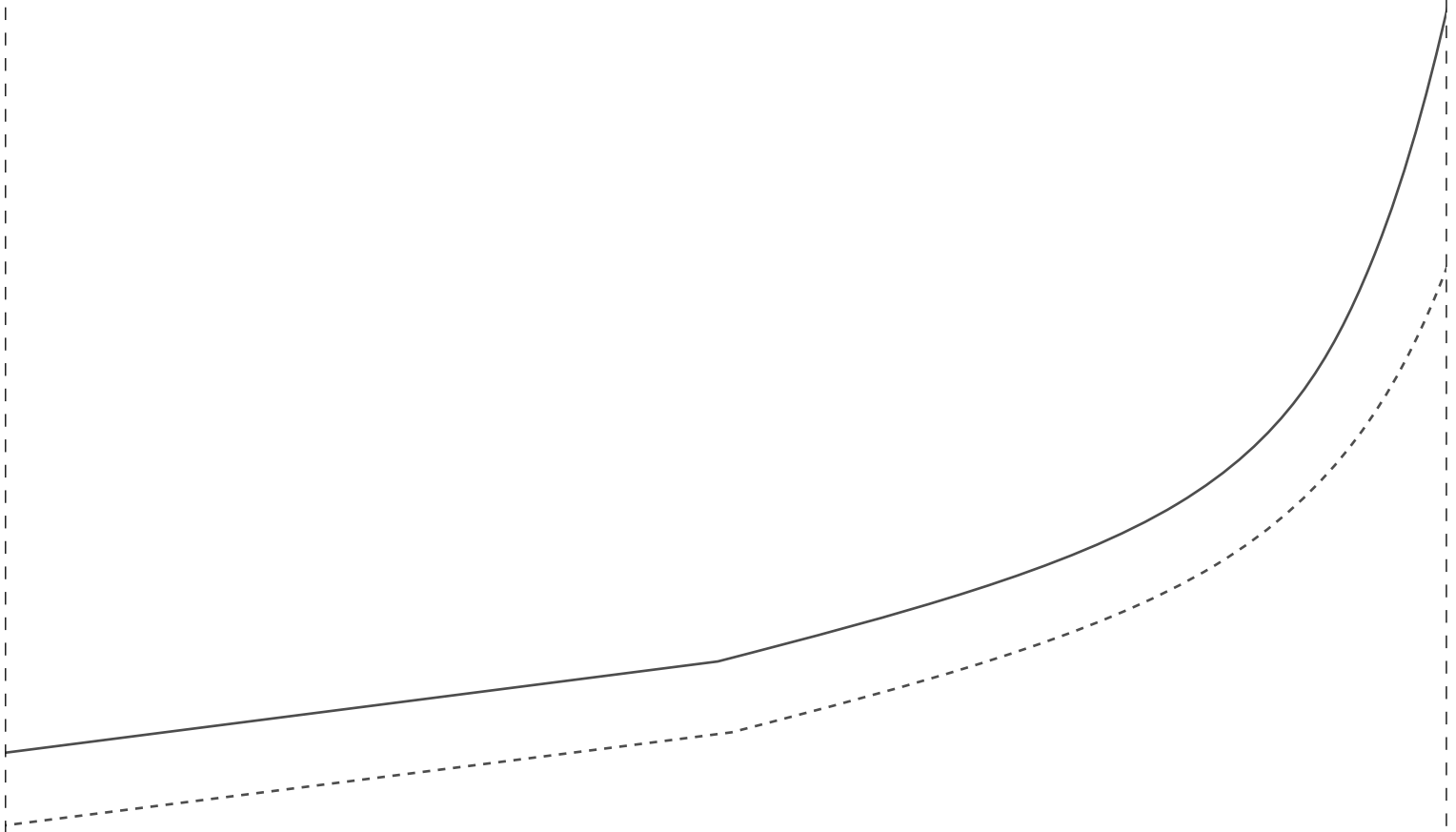

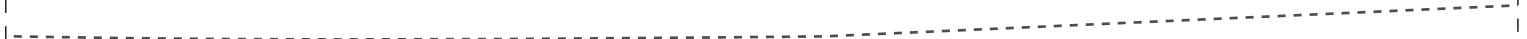

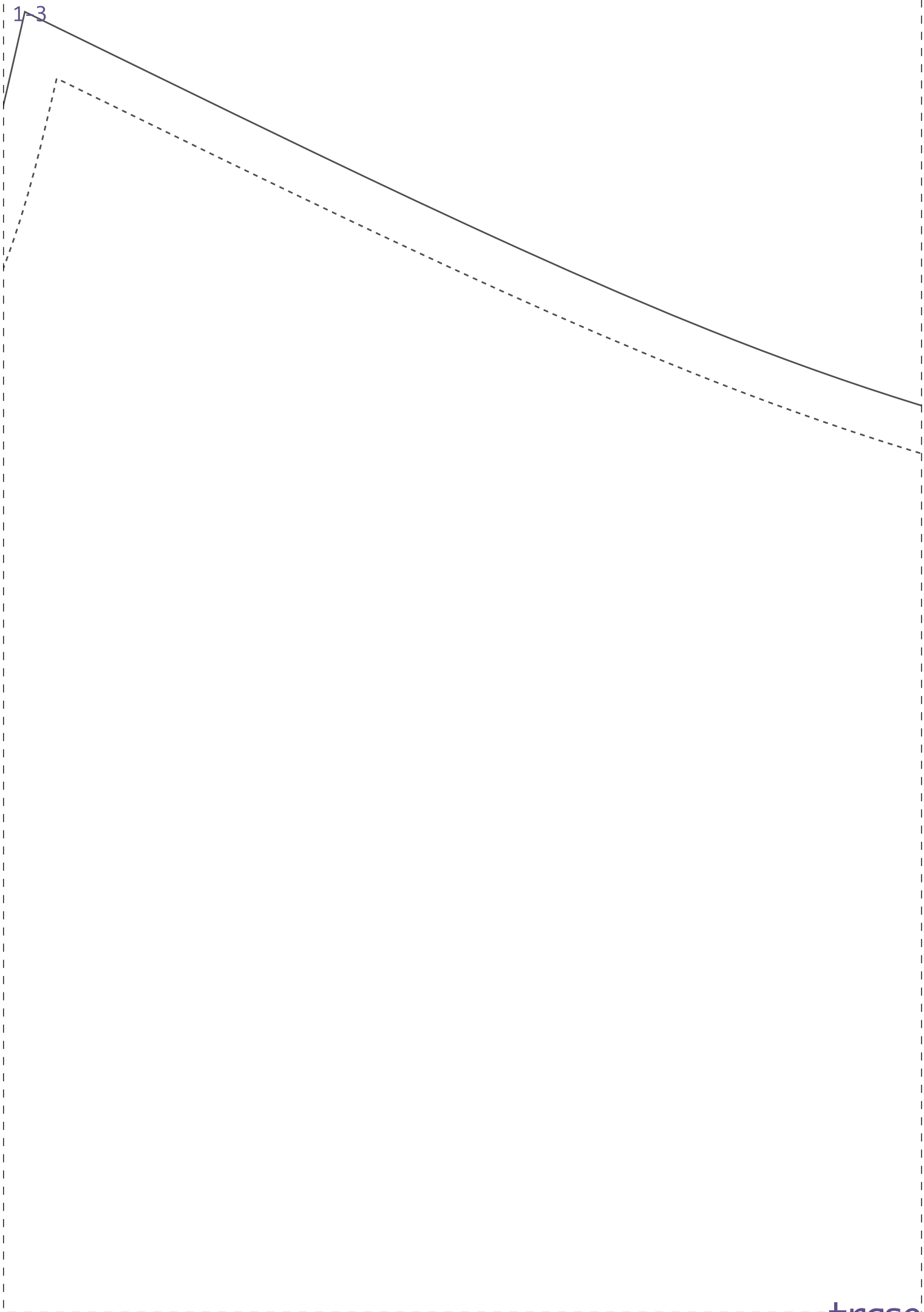

Ficha Técnica:

- Tecido Plano 1,4m de largura
- Linho, gabardine, alfaiataria ou similares
- Bolso faca
- Cós entretelado (opcional)
- 1,6m para os tamanhos 36 ao 42
- 2m para os tamanhos 44 ao 54
- 1 zíper comum 15cm

1-4

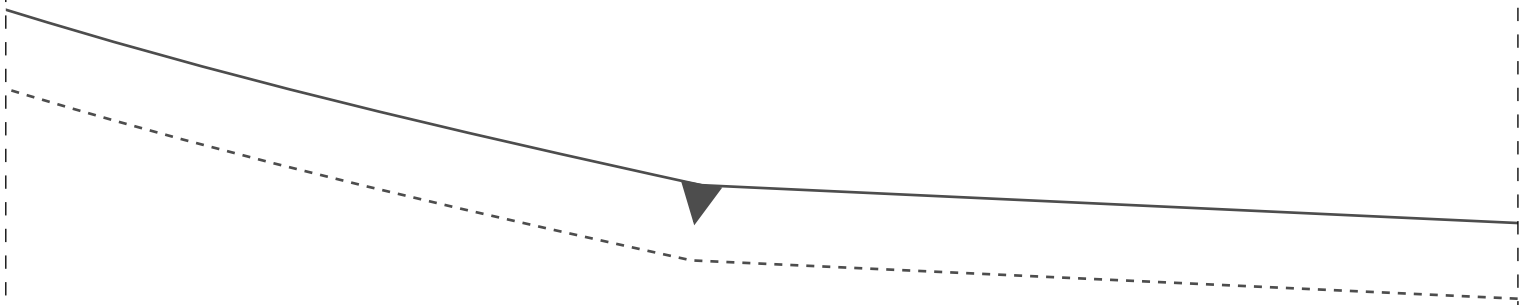

line 2x



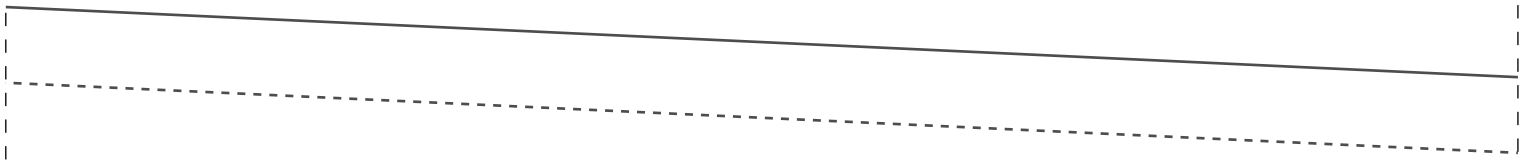

2-5



IDDED CD33



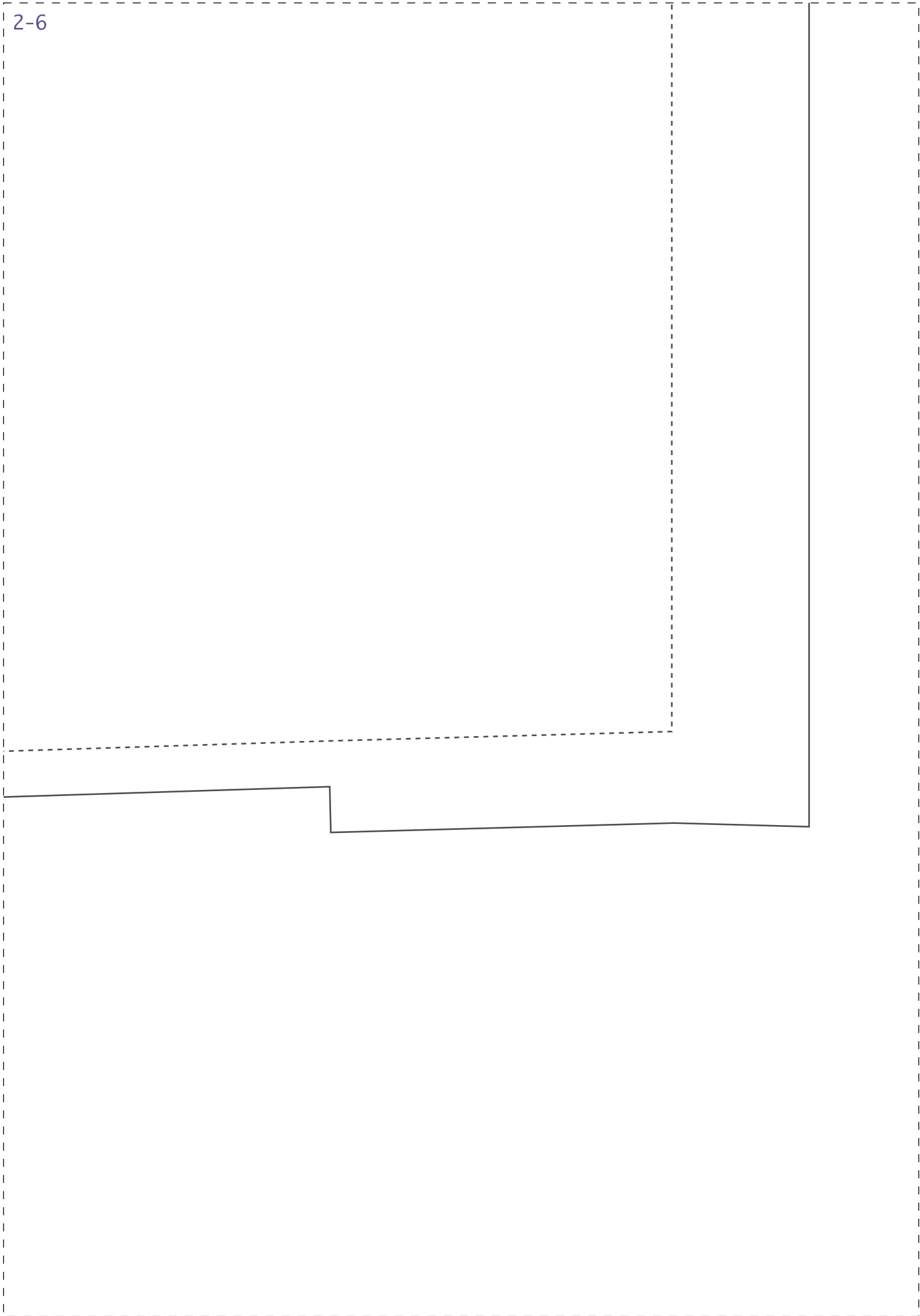

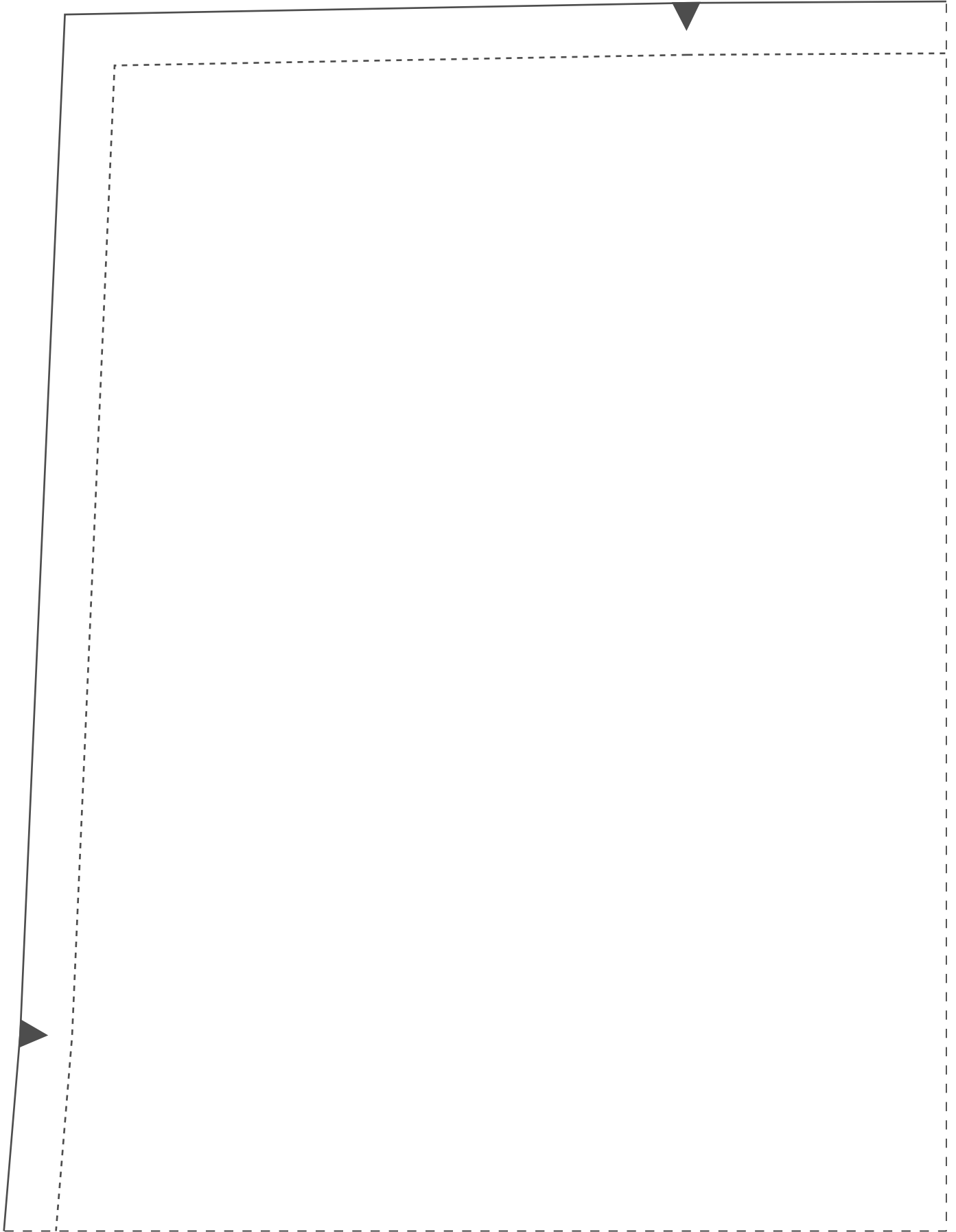

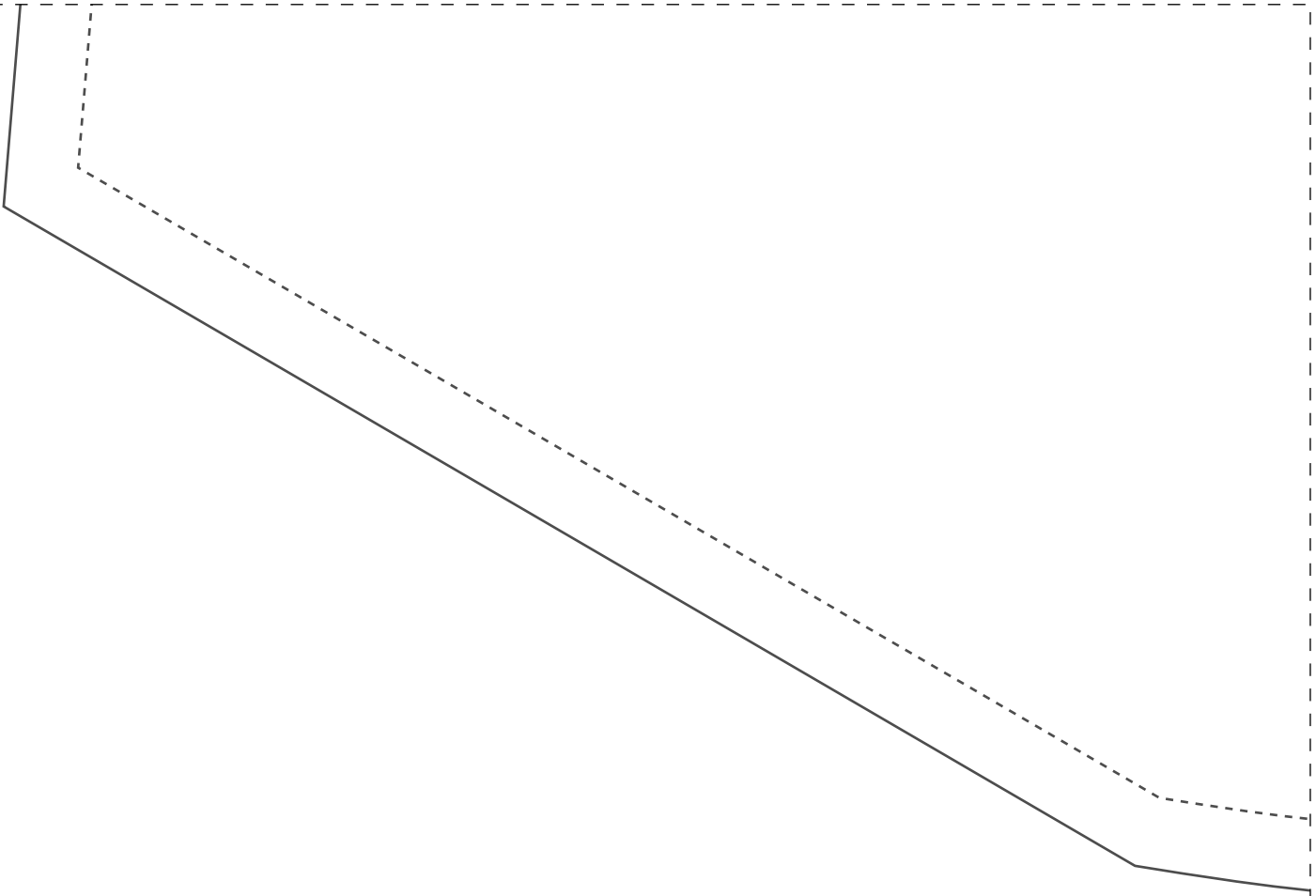

IDDED CD33

passante 4x
54

The complex block contains a dashed rectangular border. Inside this border, the text "IDDED CD33" is centered at the top. Below it, the text "passante 4x" is centered, with the number "54" centered underneath. At the bottom of the dashed box, there is a right-pointing arrow.

1-8

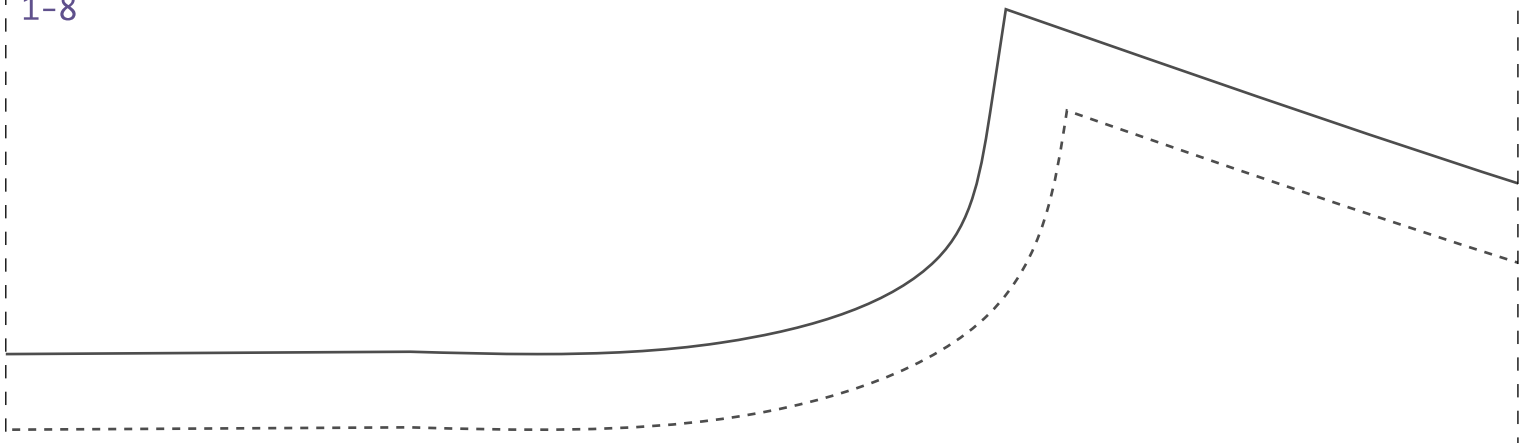

Instituto Diana Demar
Escola de Costurar
IDD Fashion Day
Calça Feminina Alfaia

PROIBIDA REVENDA

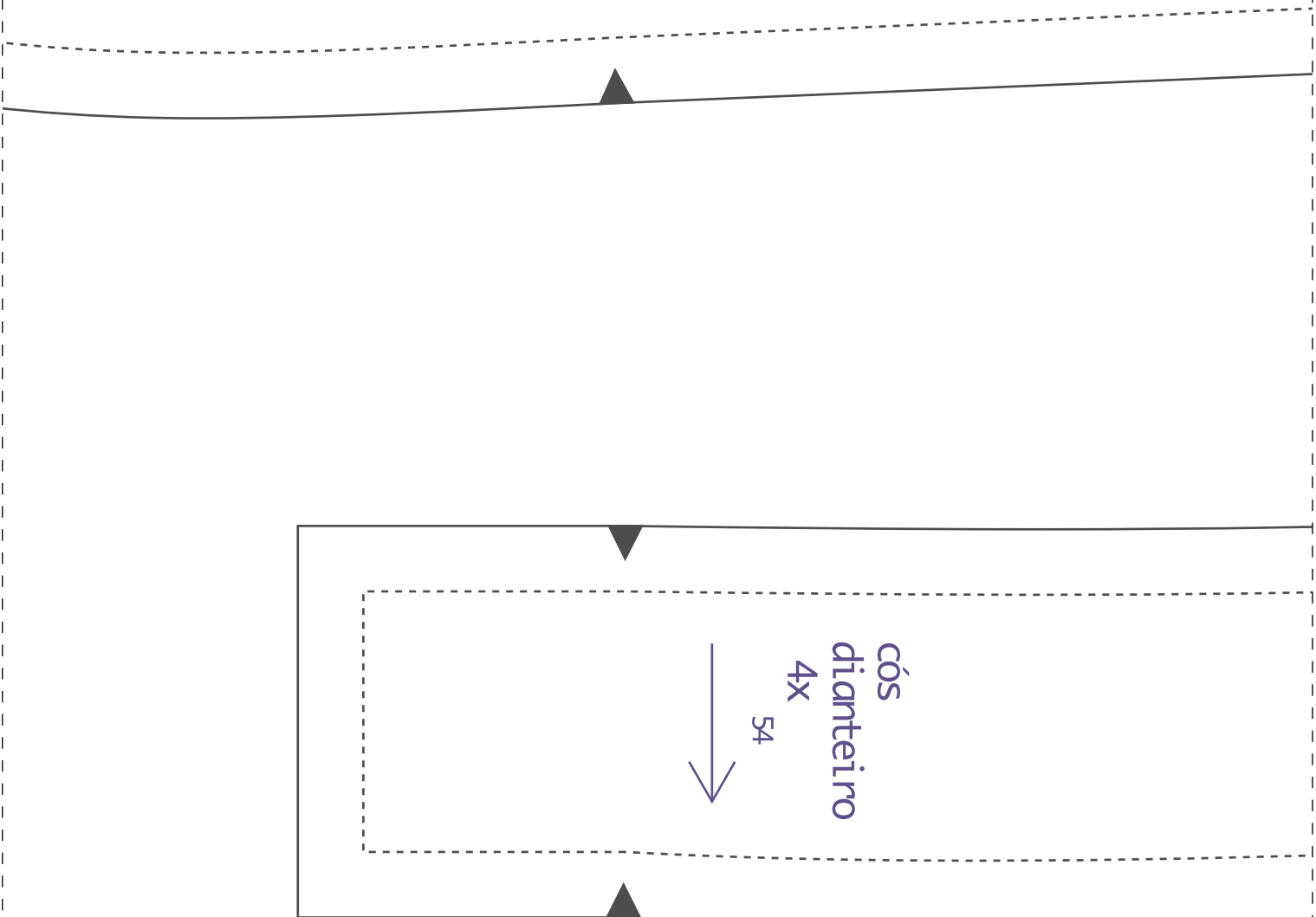

1-9

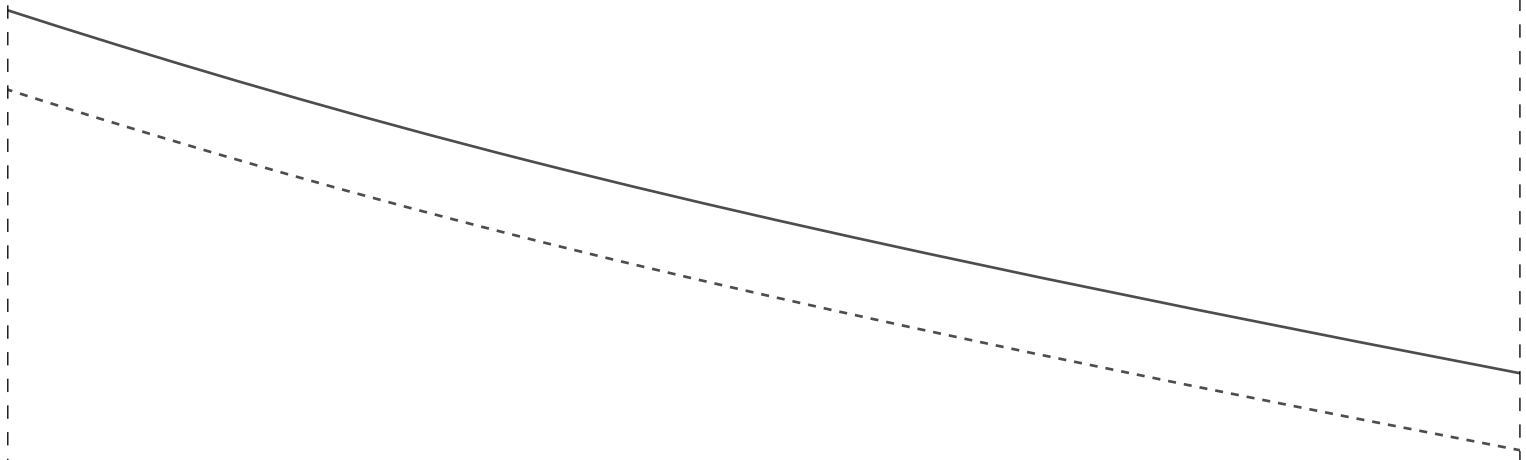

dianteiro 2x

54



chi

taria

IDDED CD33

1-10

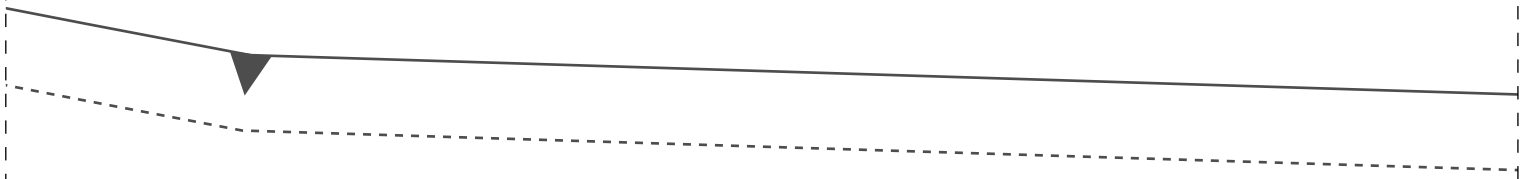

IDDED CD33

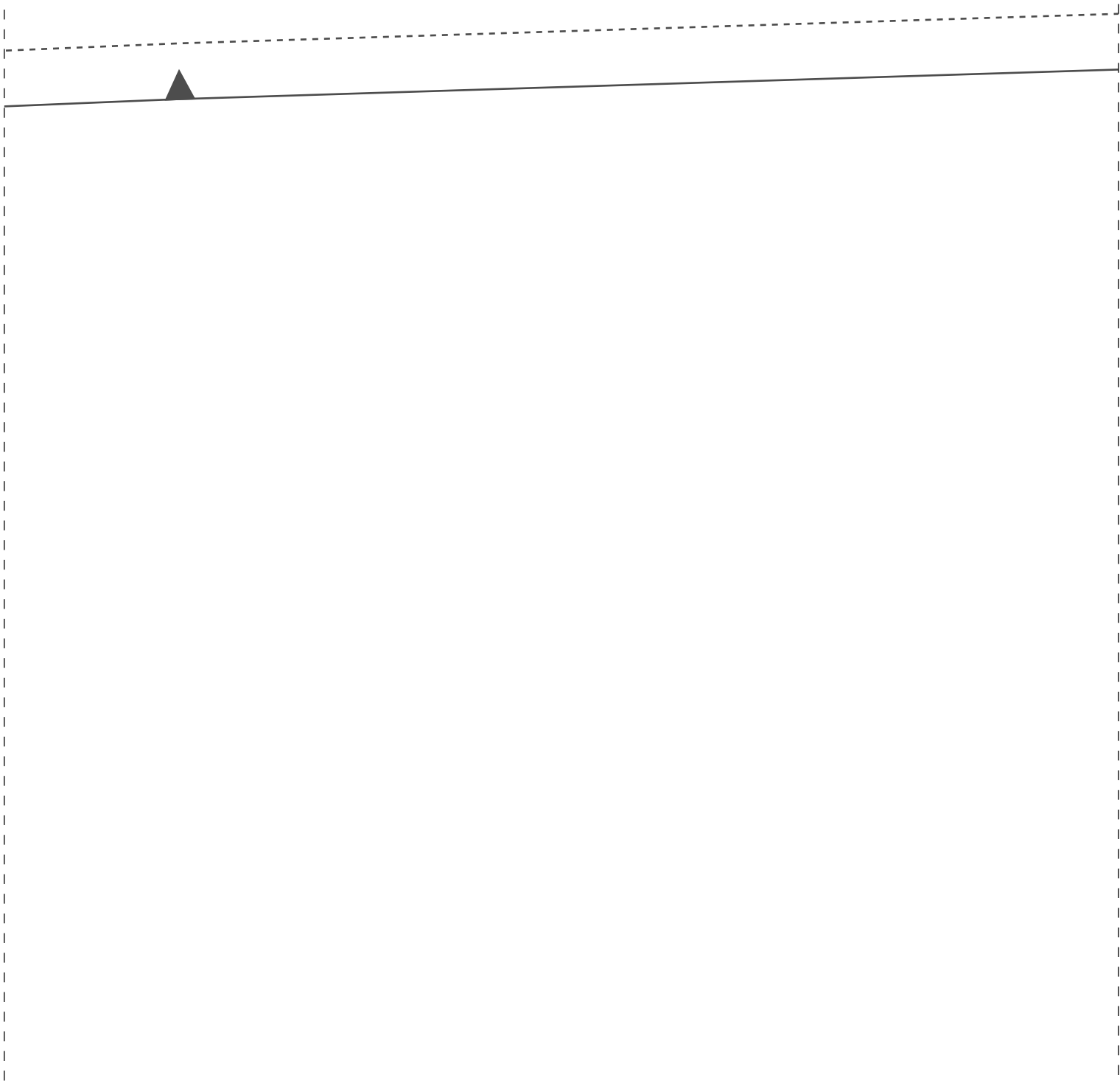

1-11

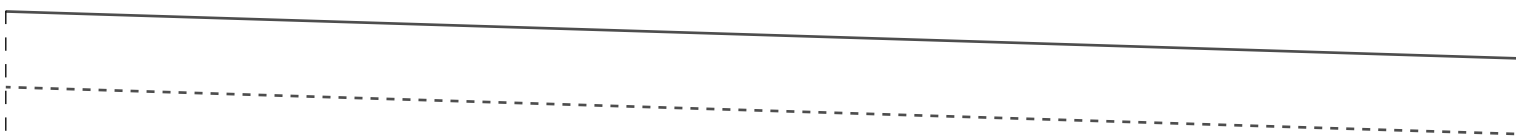



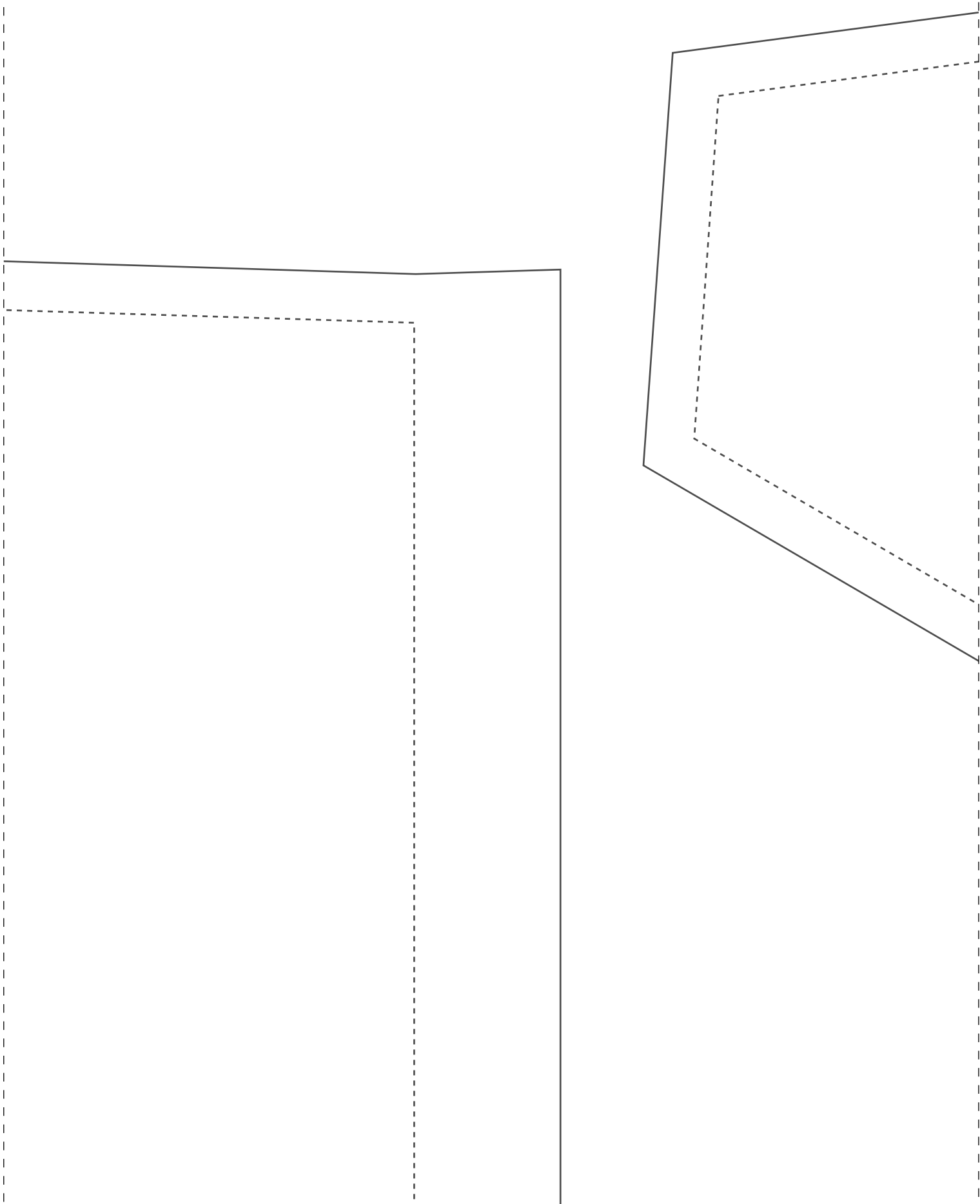

1-13

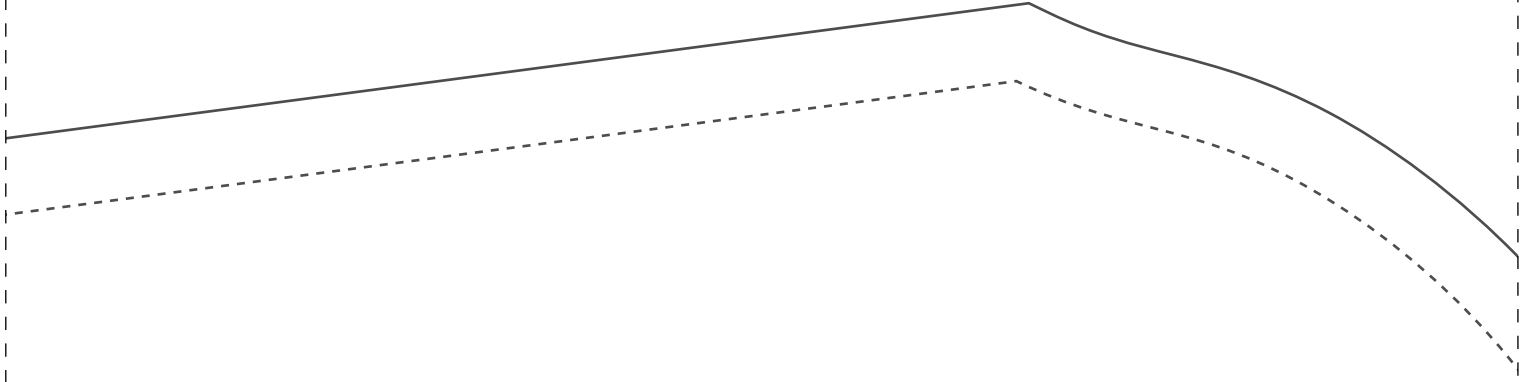

bolso 2x
54



IDDED CD33

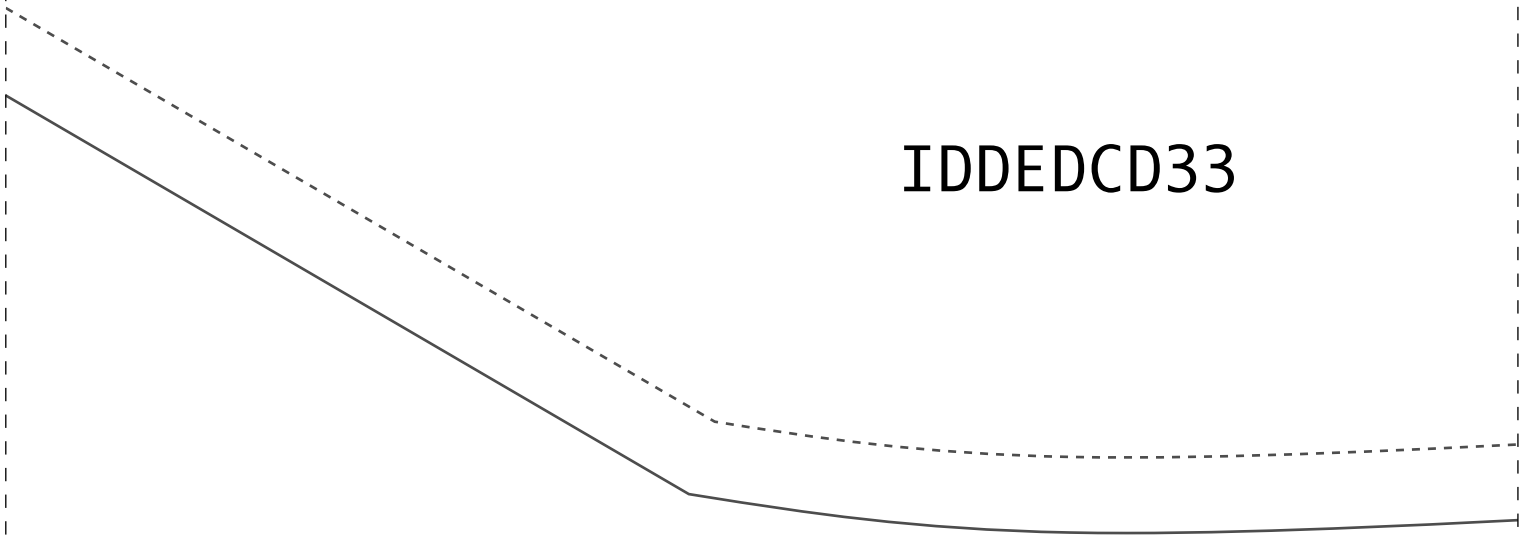



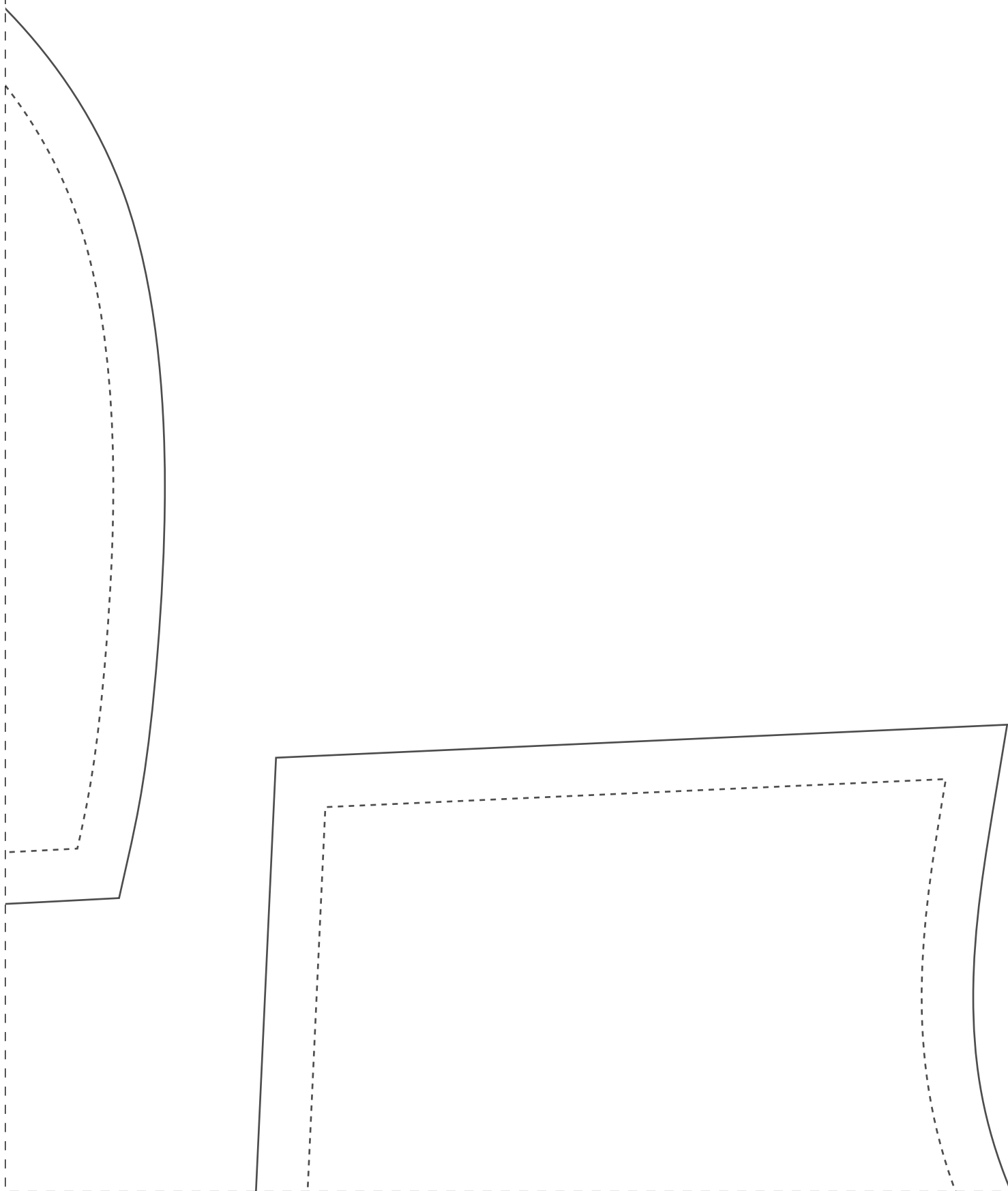

2-14

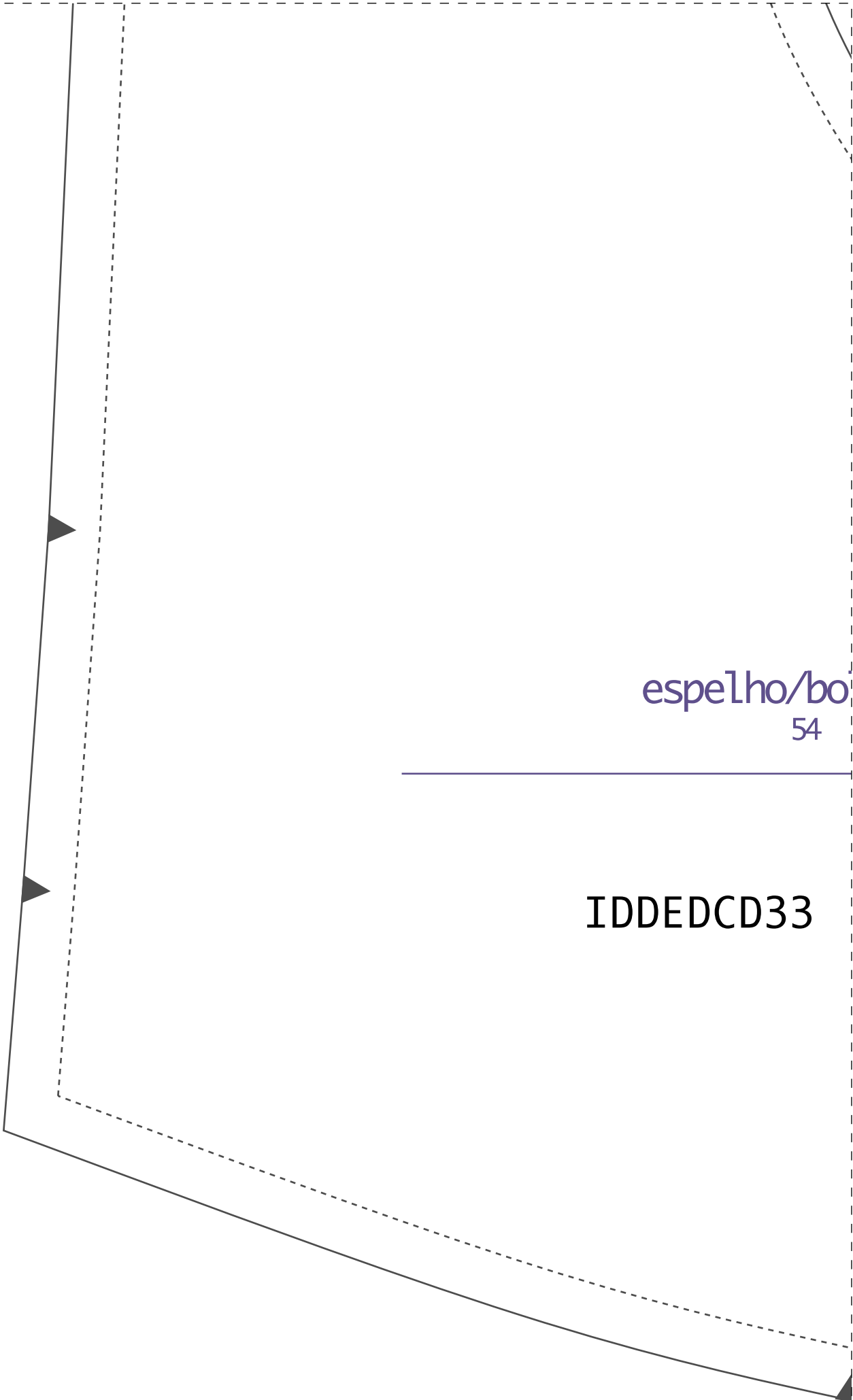

espelho/bo
54

IDDED CD33

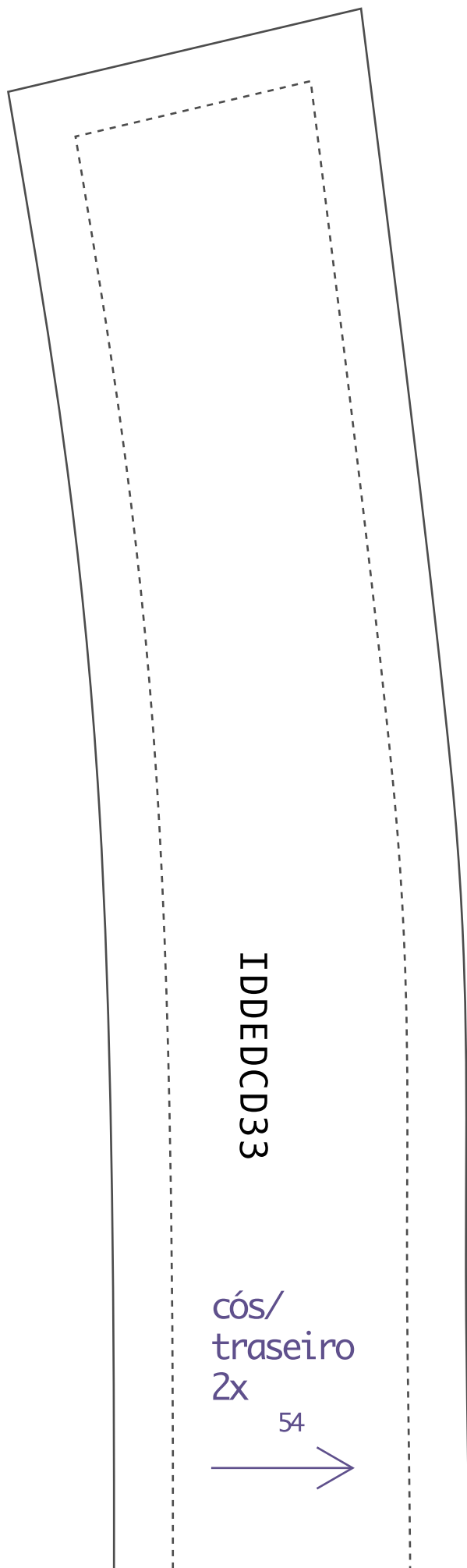

IDDEDCCD33

cós/
traseiro
2x

54



2-15

dobra

Iso 2x

