

1-1

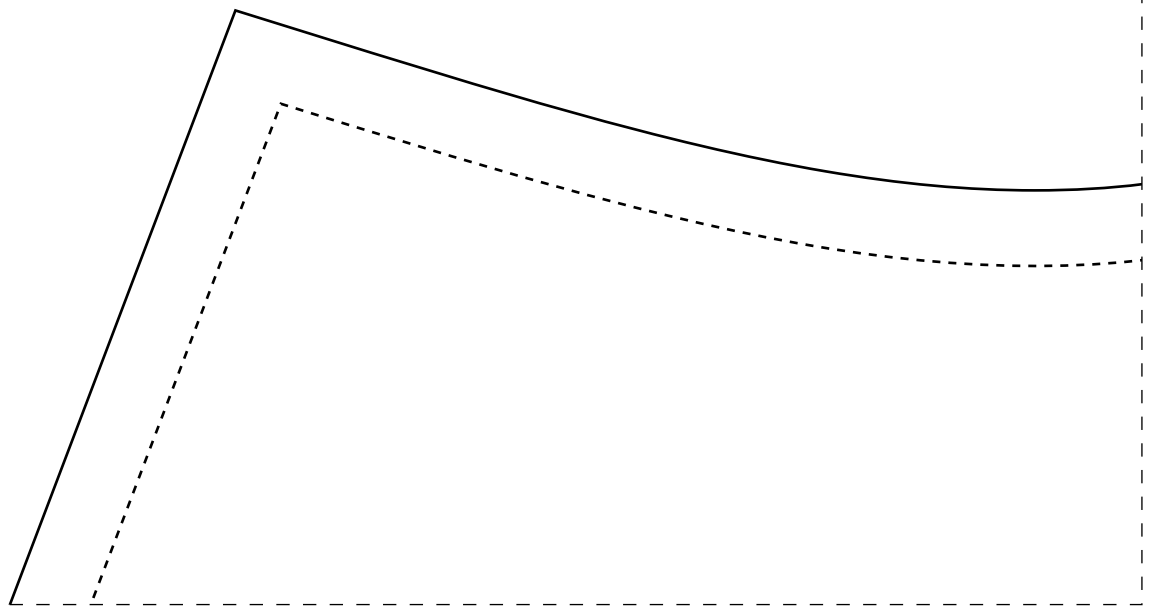

2-1

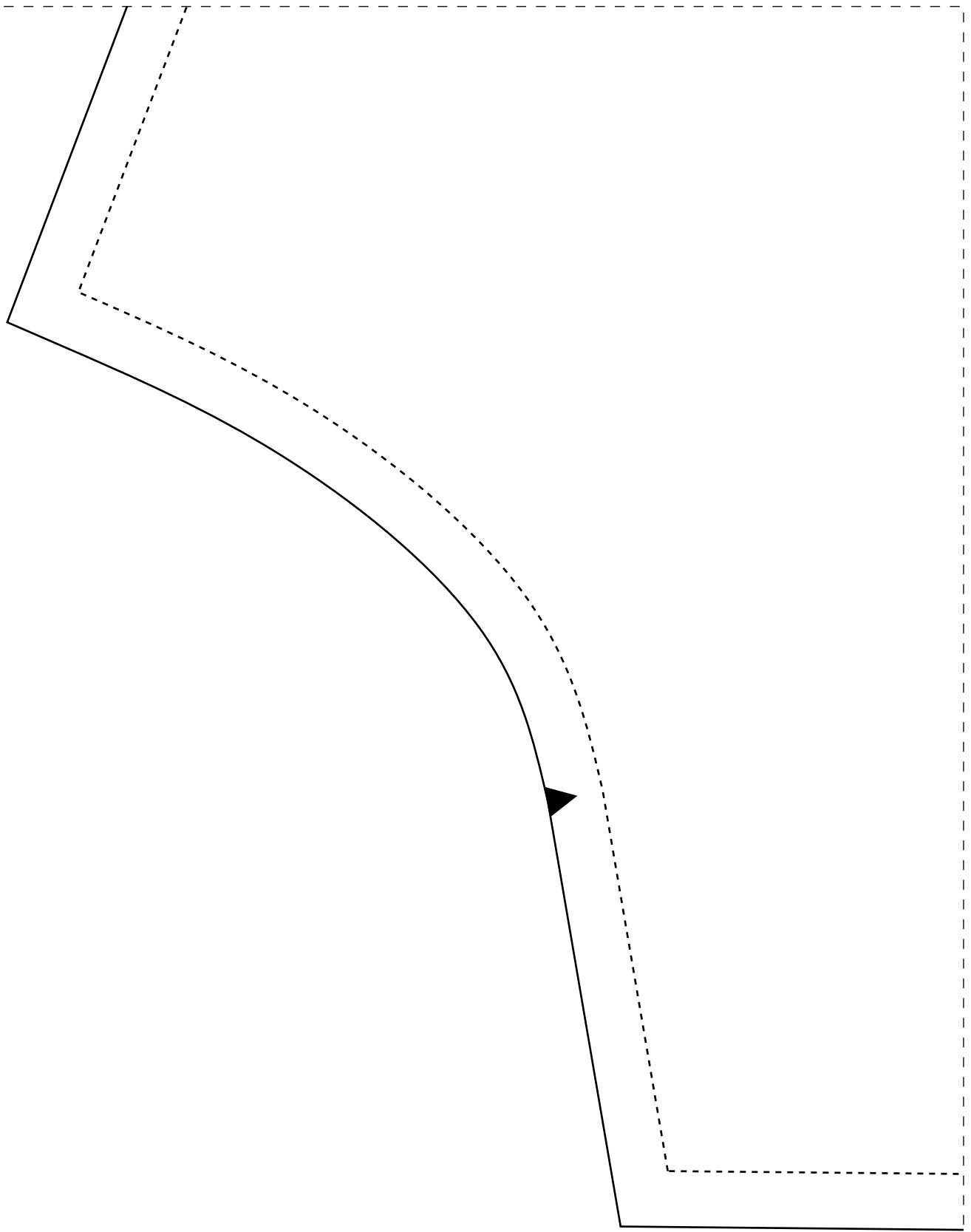

dobra

IDDED CD34

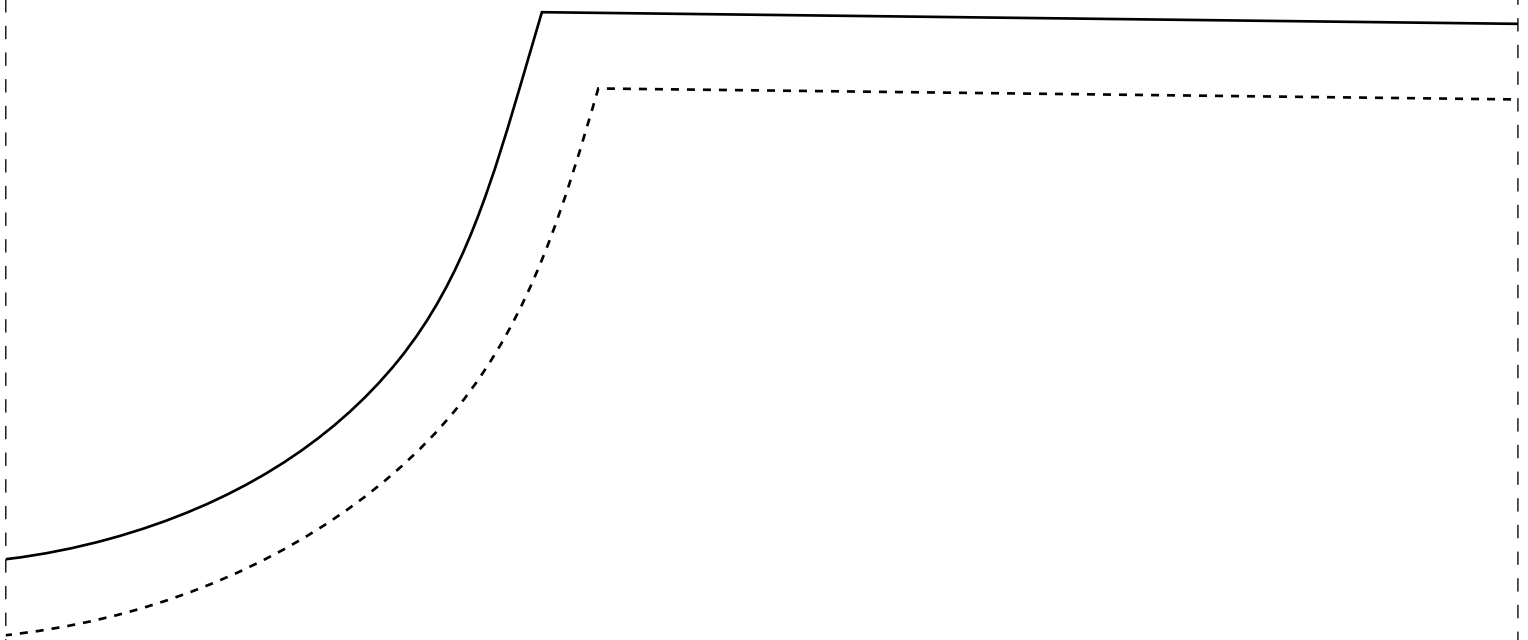

Instituto D
Escola de C
IDD Fashion
Colete Femi

PROIBIDA RE





2-3

iana Demarchi
osturar
Day
nino Alfaiataria

VENDA

frente 2x
42

cinto 2x
42

1-4

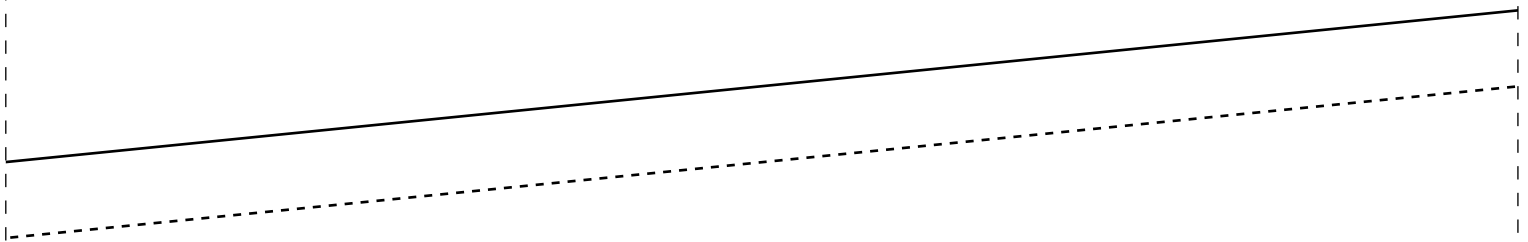

IDDED CD34

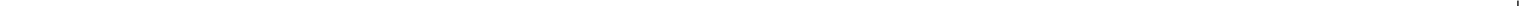

3-4

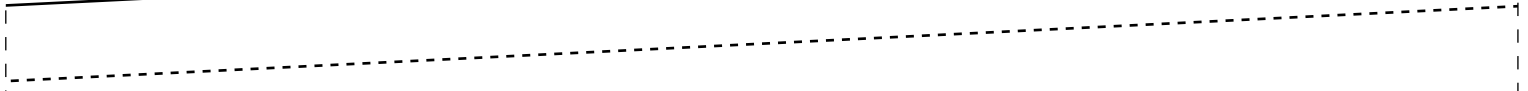

1-5

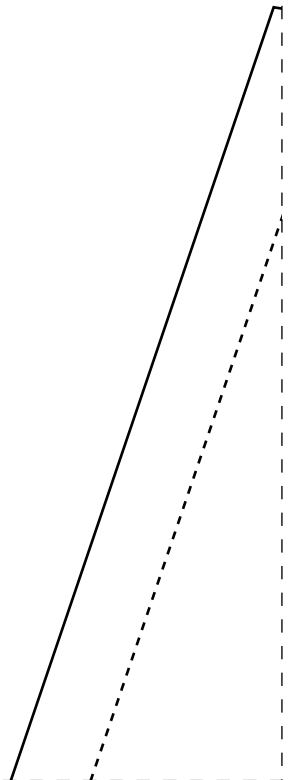
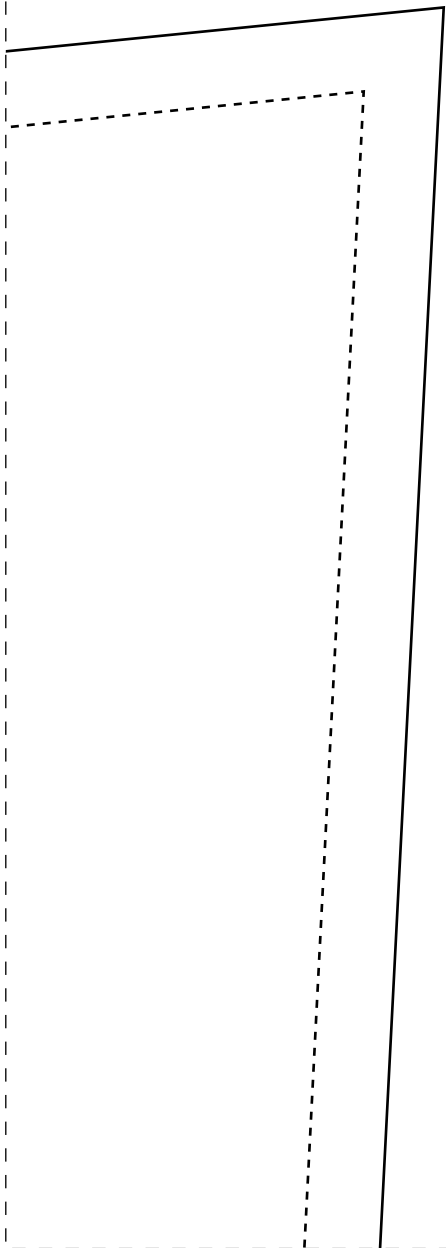

2-5

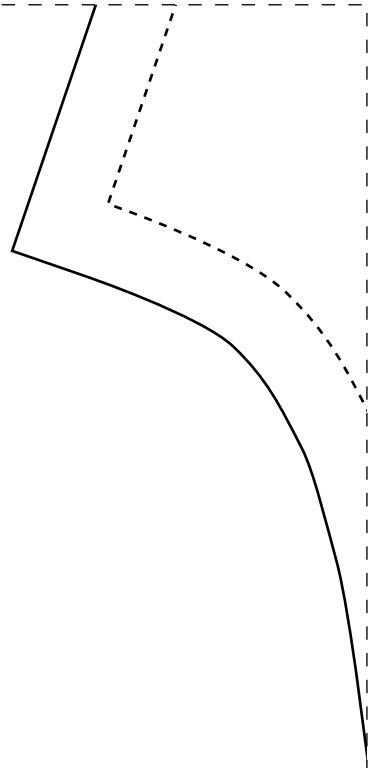

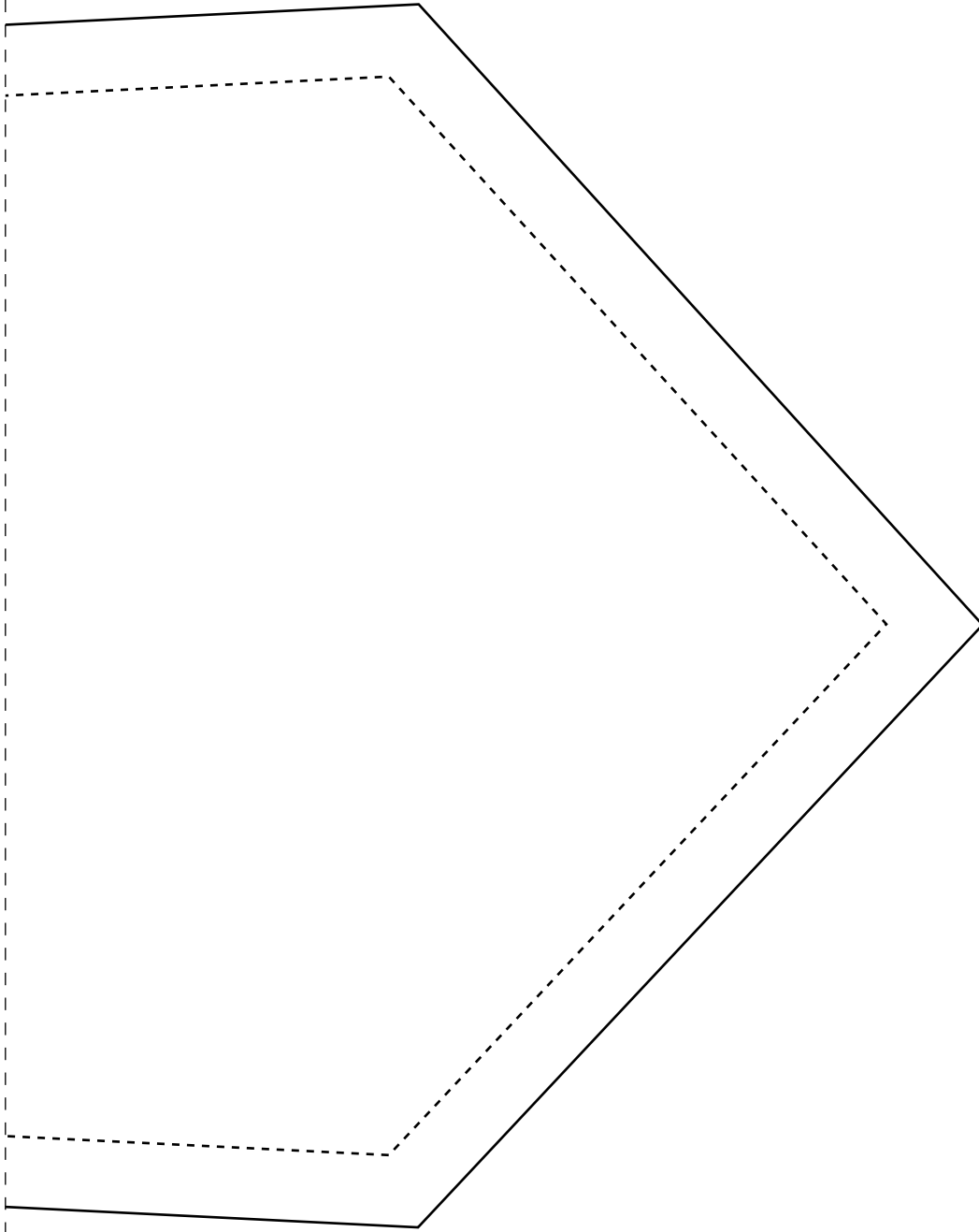

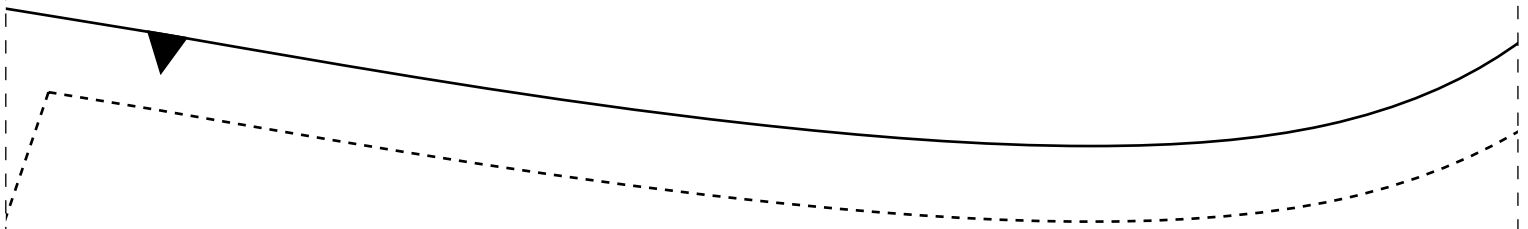

dobra

IDDED CD34

gola 2x



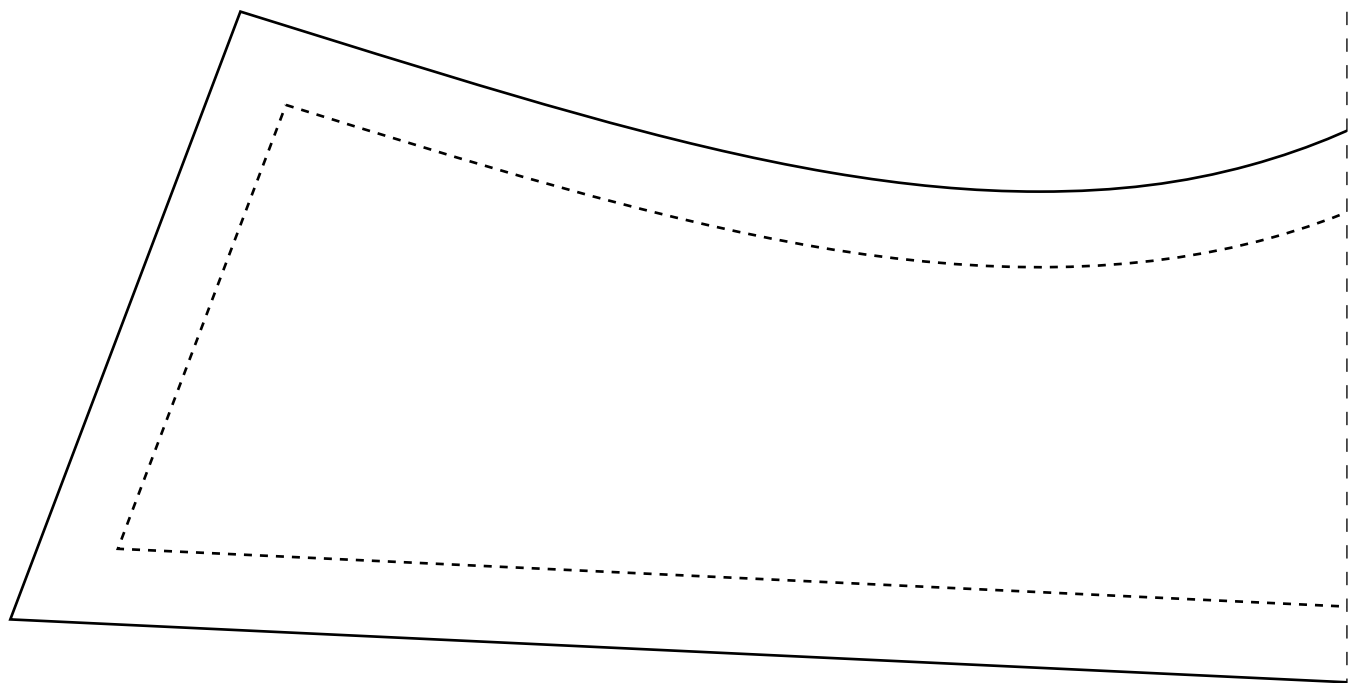

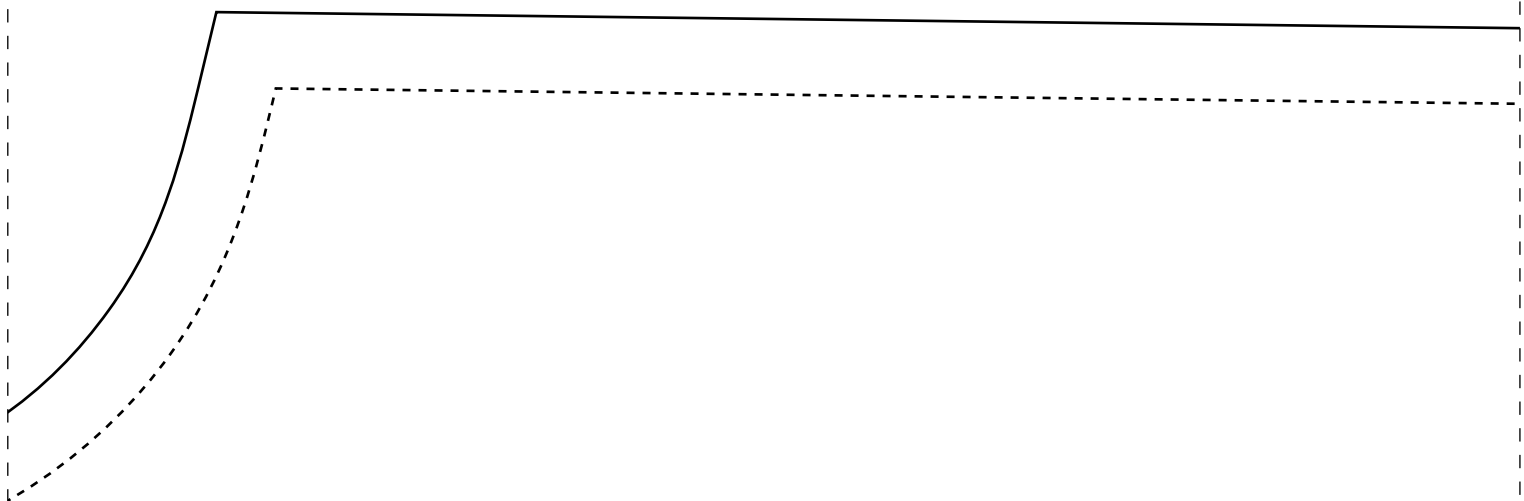

FICHA TÉCNICA:

TECIDO PLANO COM 1,4m DE LA

-Linho, gabardine, alfaiate
ou similares

-Limpeza da peça com forro

-1,9m para os tamanhos 36 e

-2,3m para os tamanhos 44 e

-Forro: 1m para todos os t

2-7

costas 2x
42

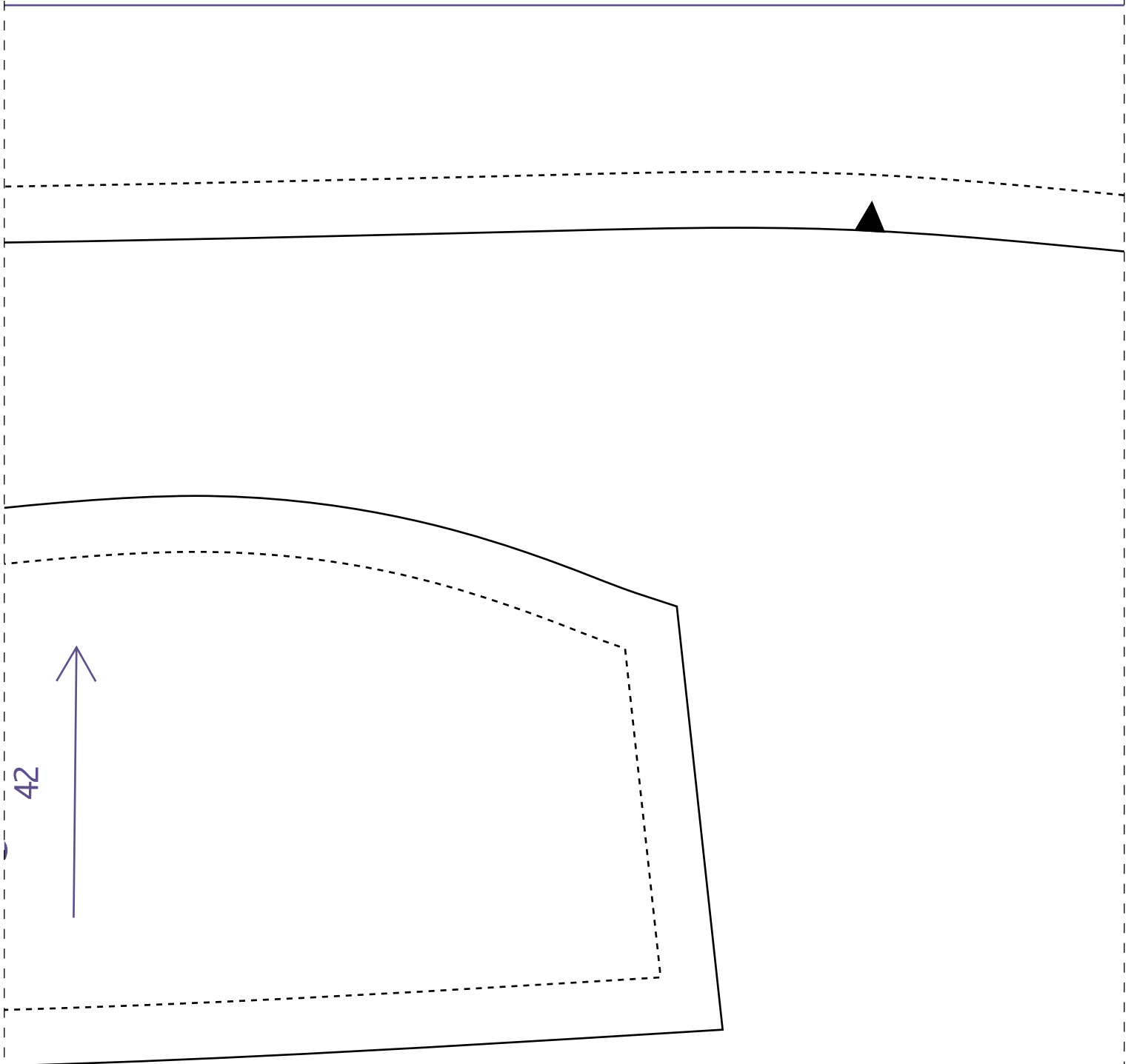

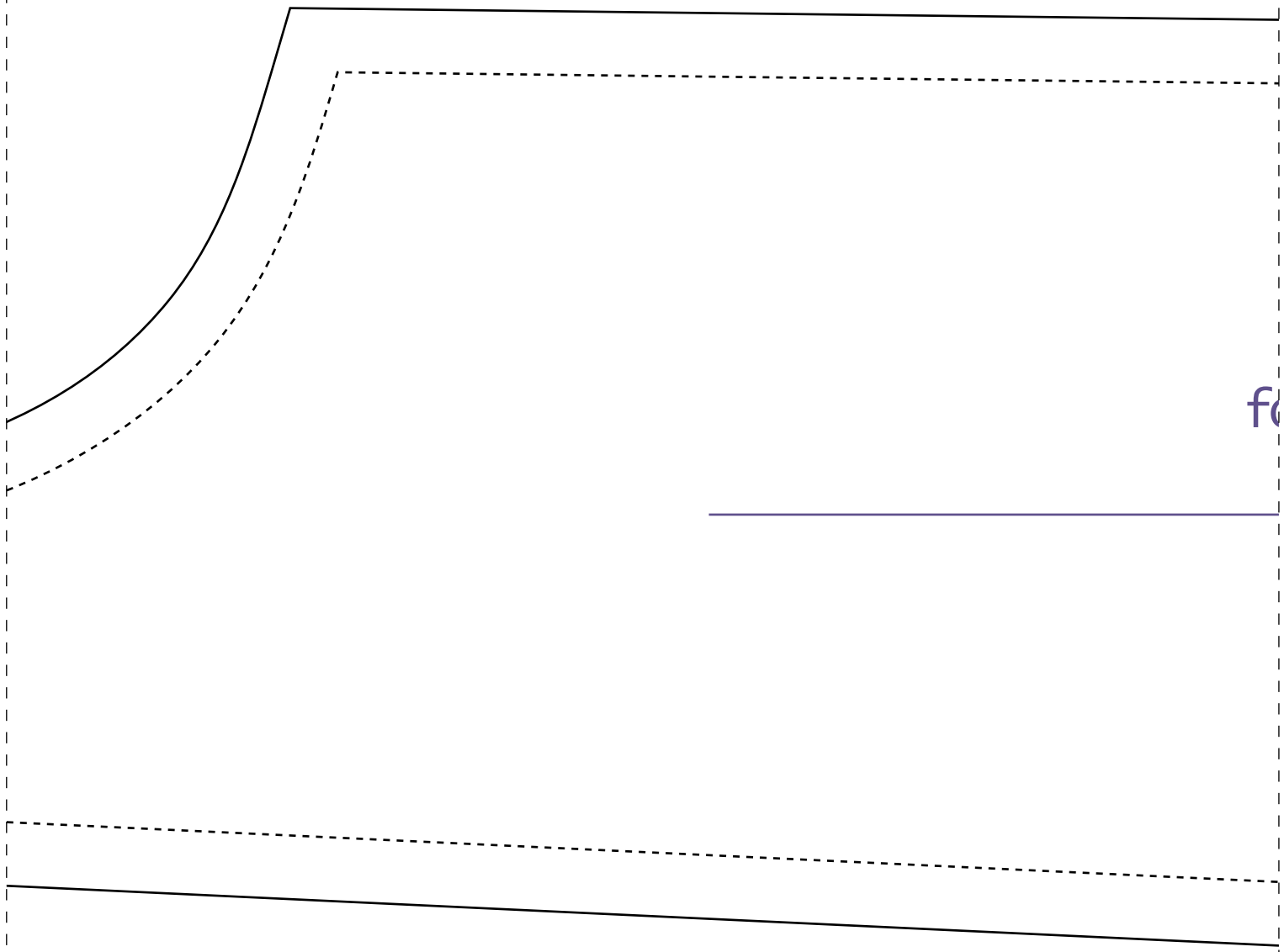

fo

1-8

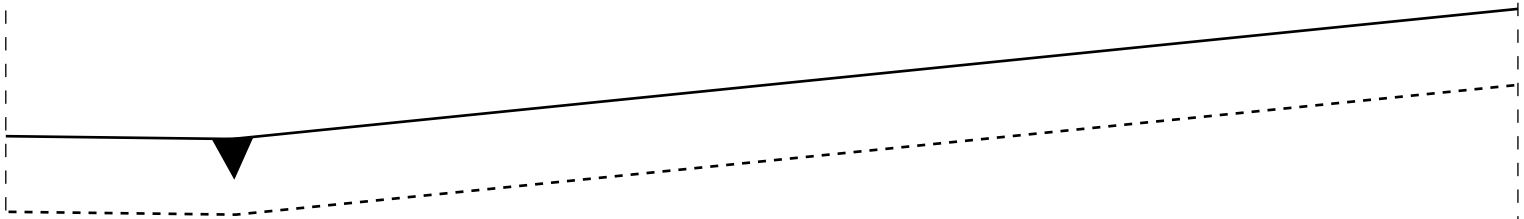

ARGURA
aria

ao 42
ao 54
manhos

IDDED CD34

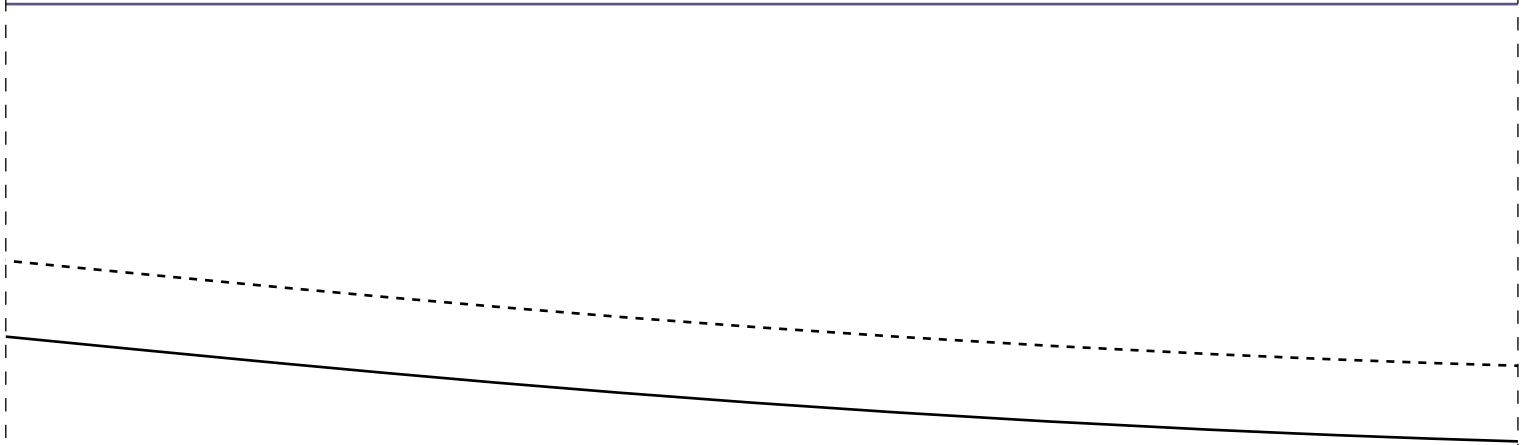

3-8

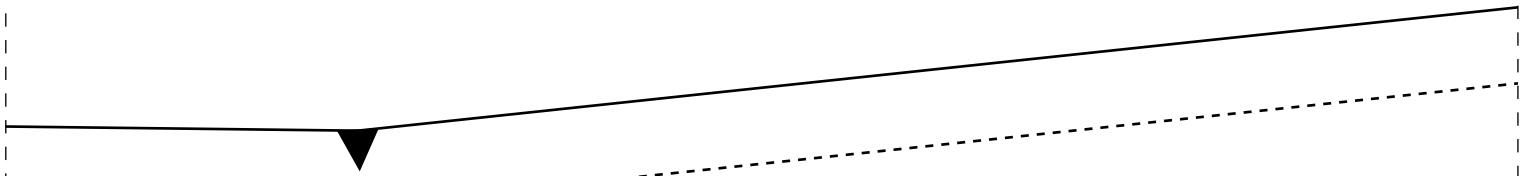

porro/frente 2x
42

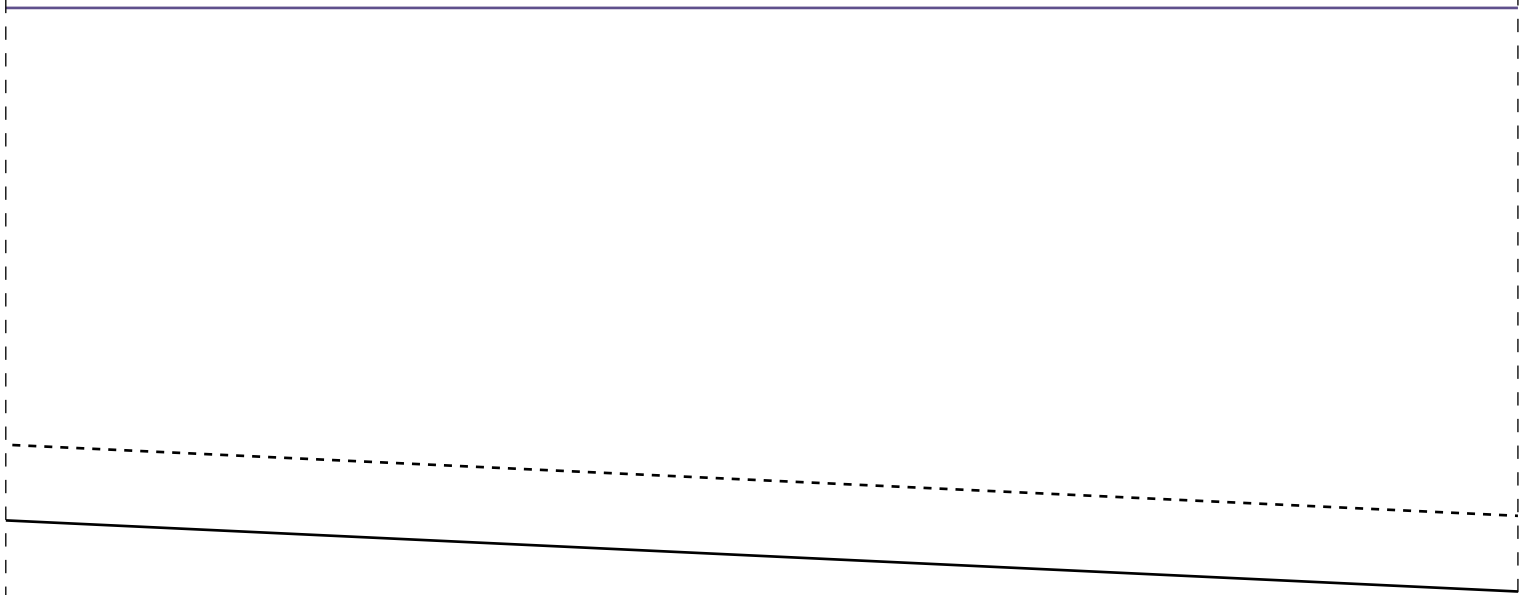

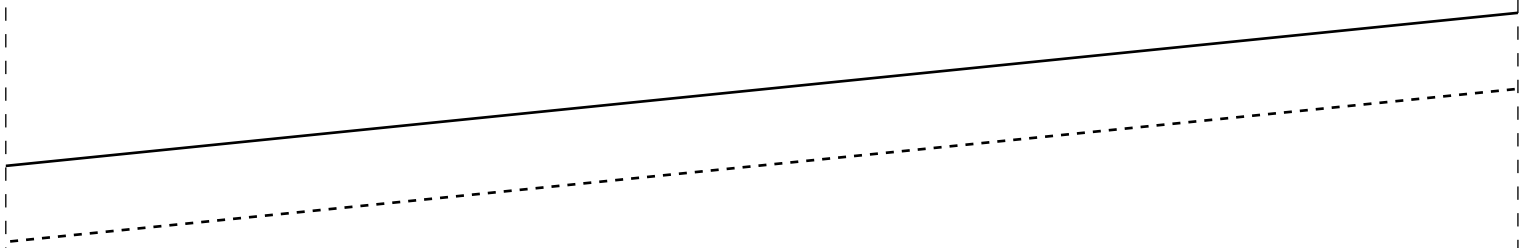

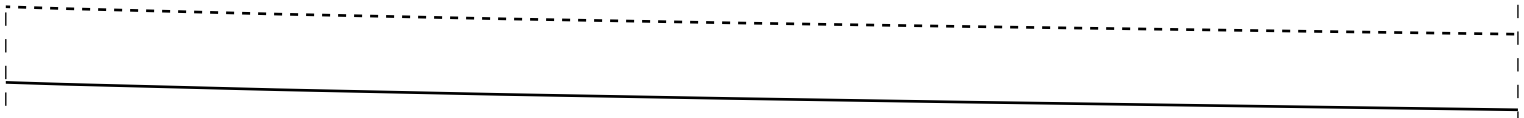

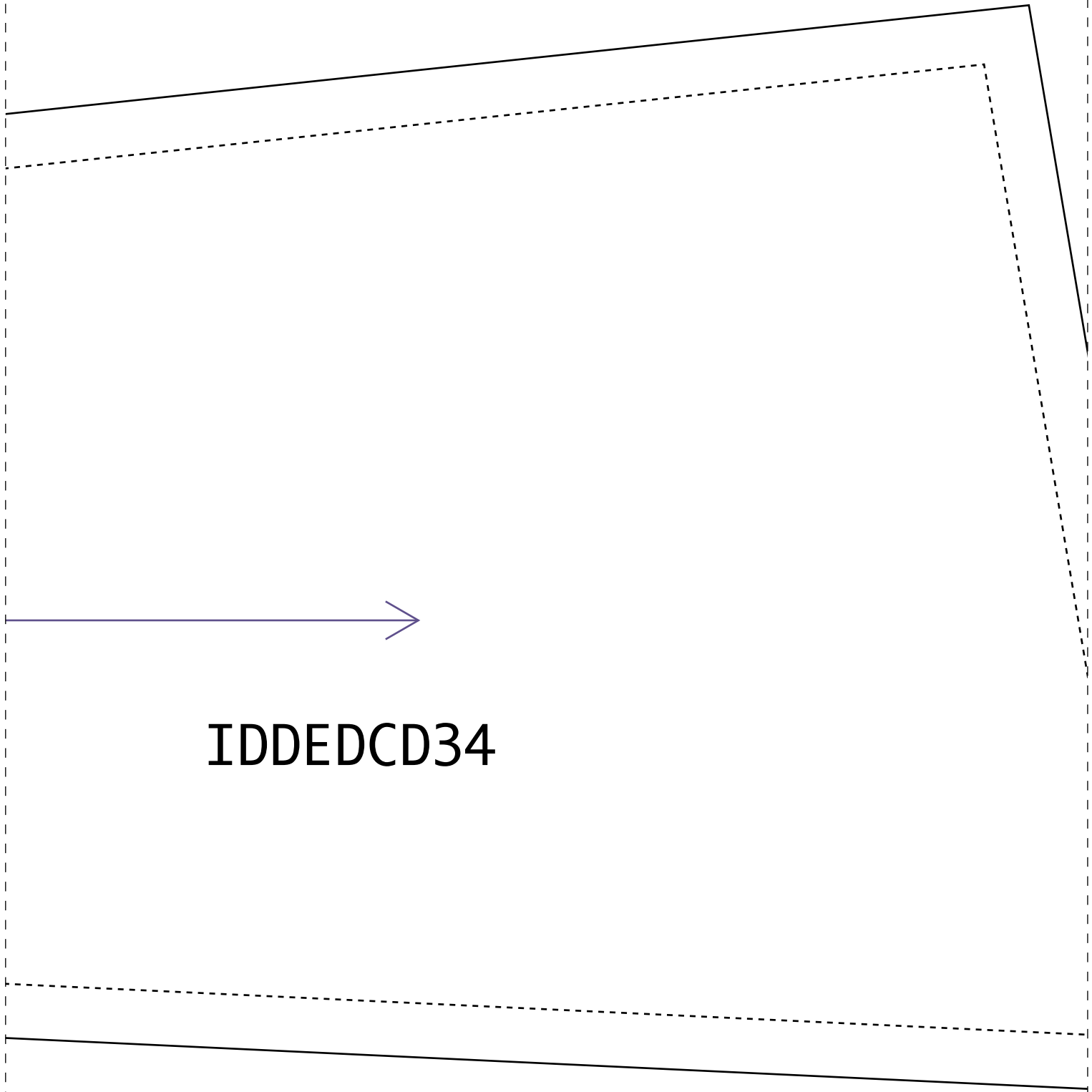

IDDED CD34

1-10

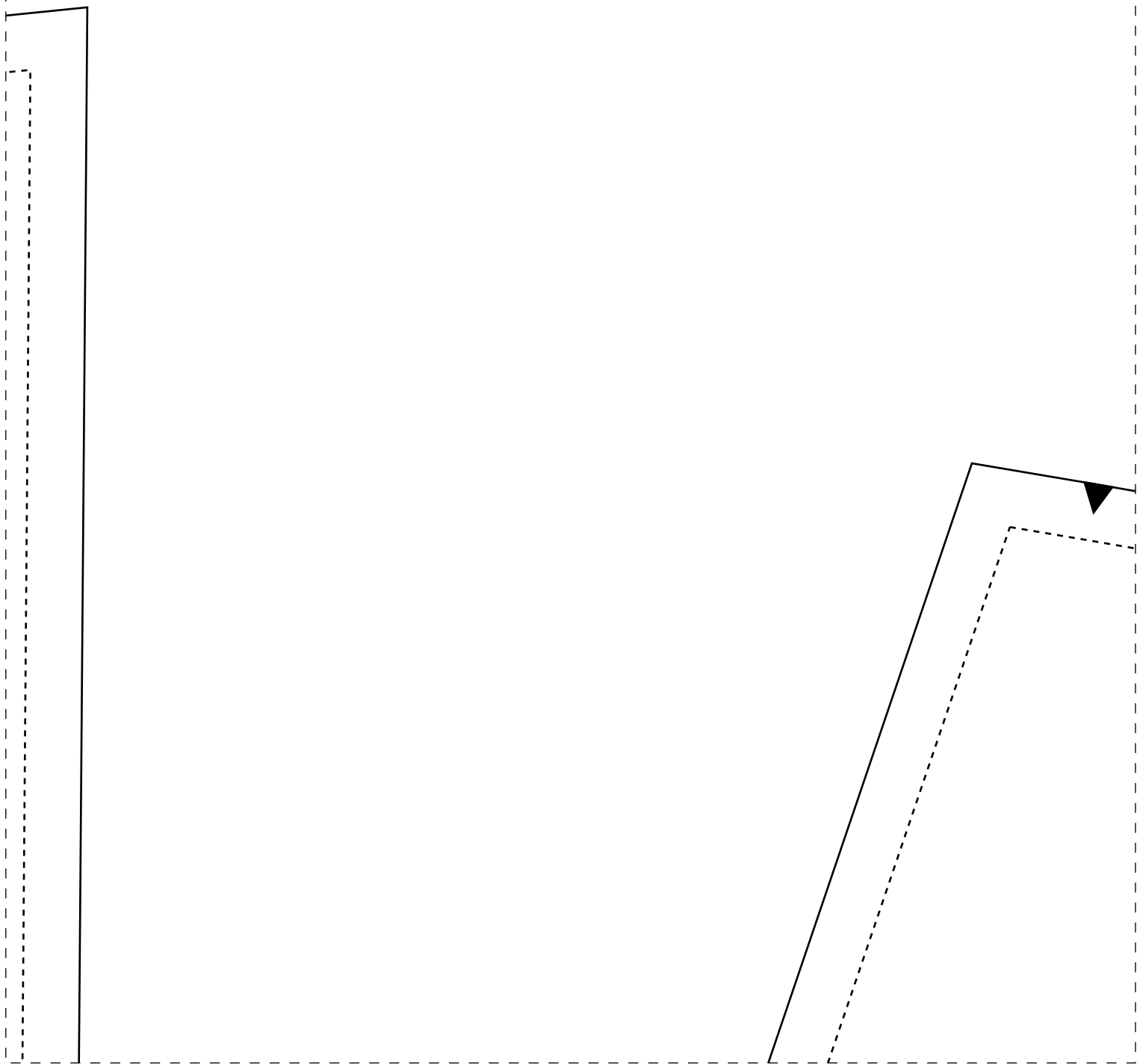

3-10

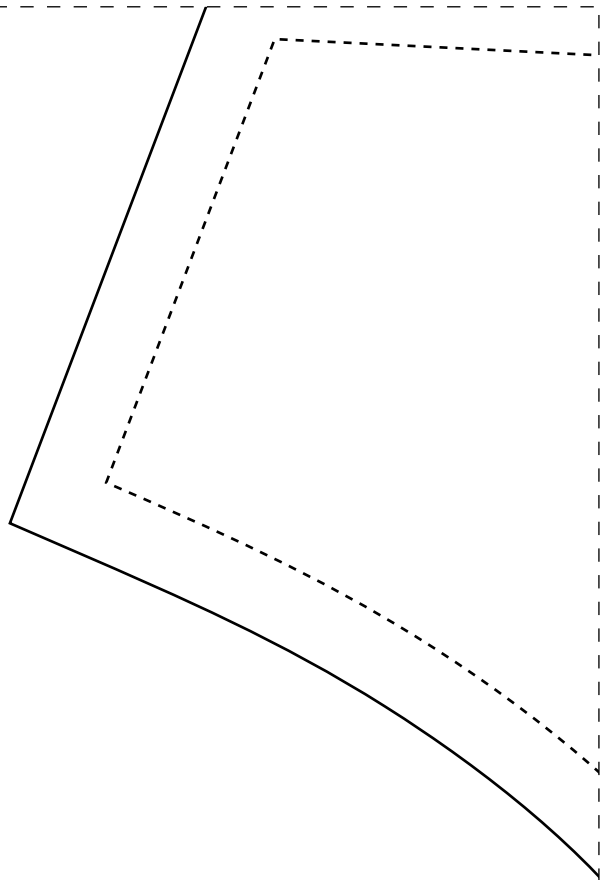
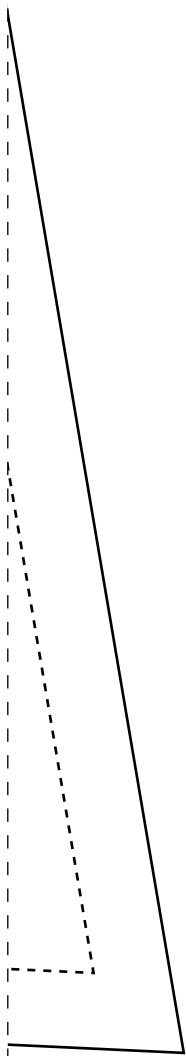

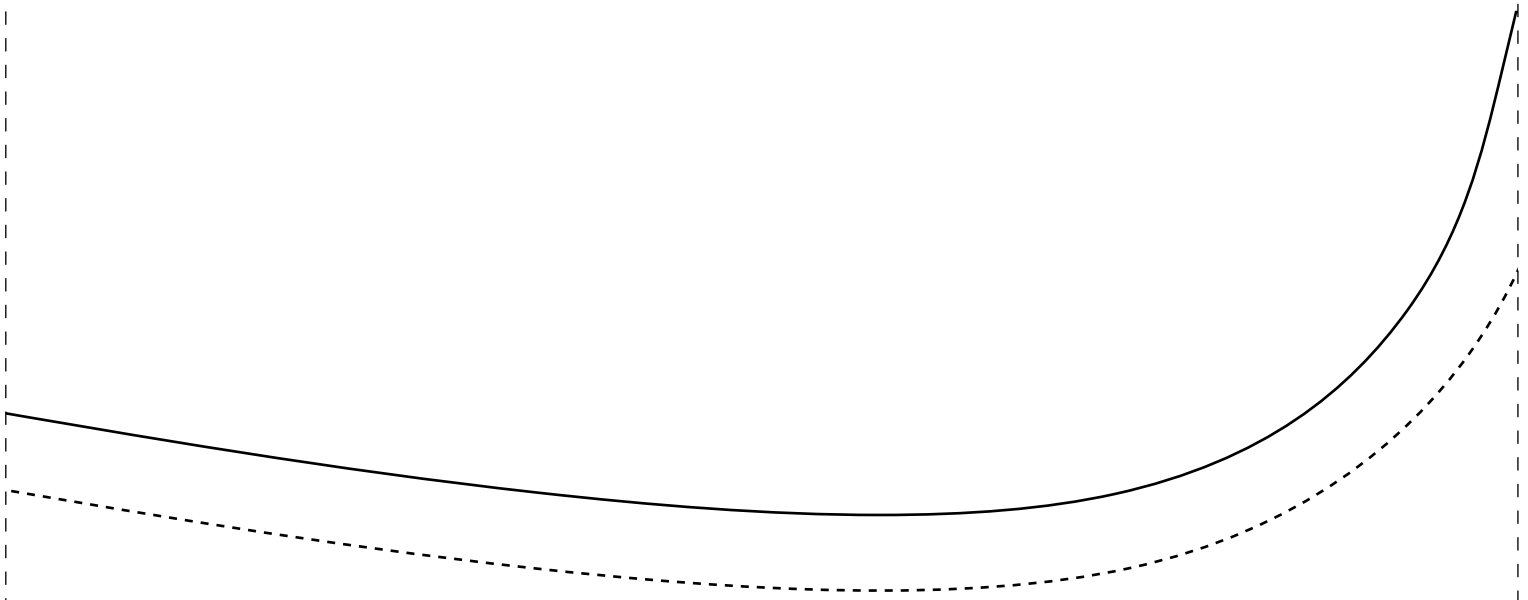



3-11

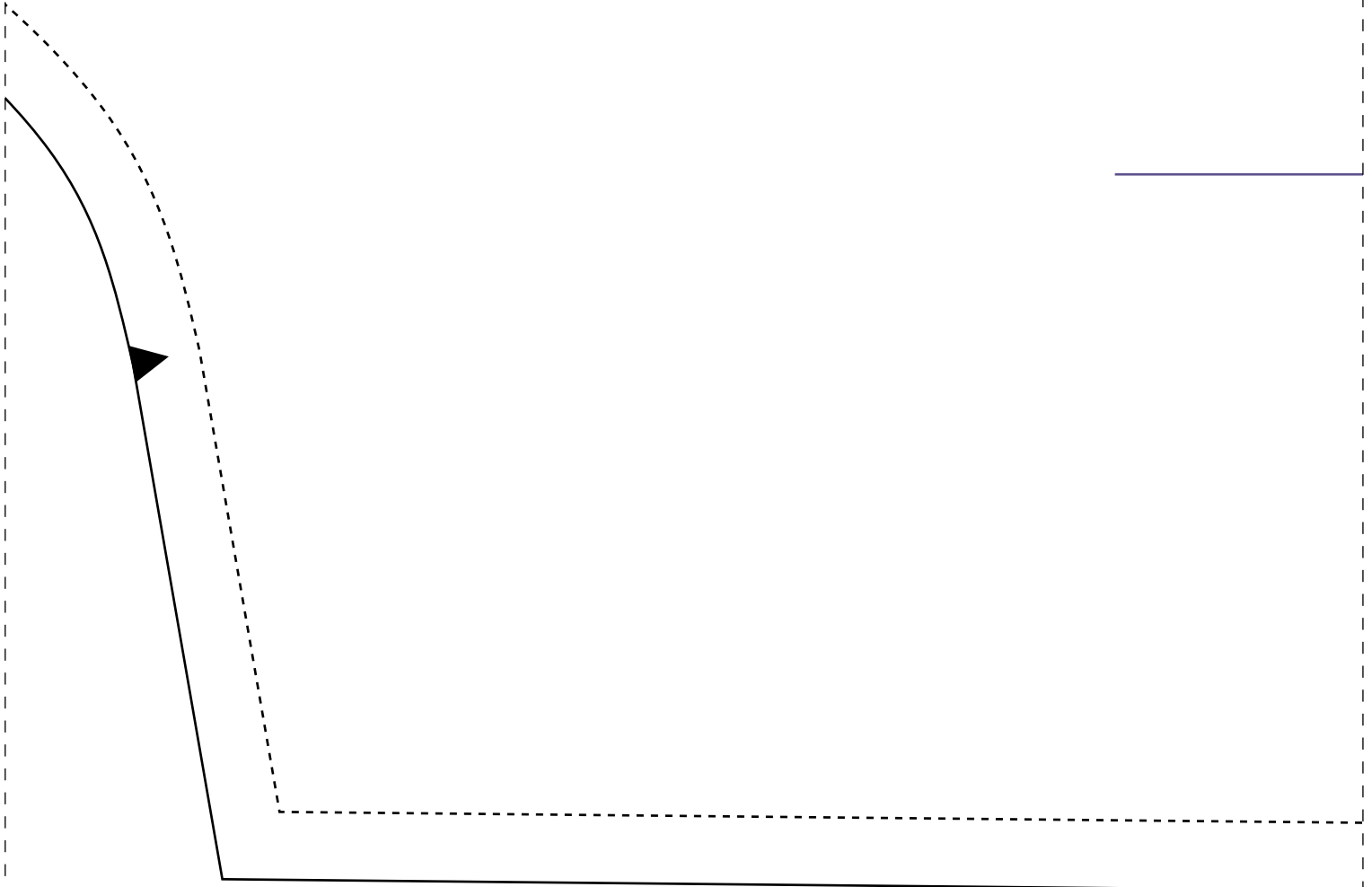

Instituto Diana Demarchi
Escola de Costurar
IDD Fashion Day
Colete Feminino Alfaiataria

PROIBIDA REVENDA

forro/costas 2x
42

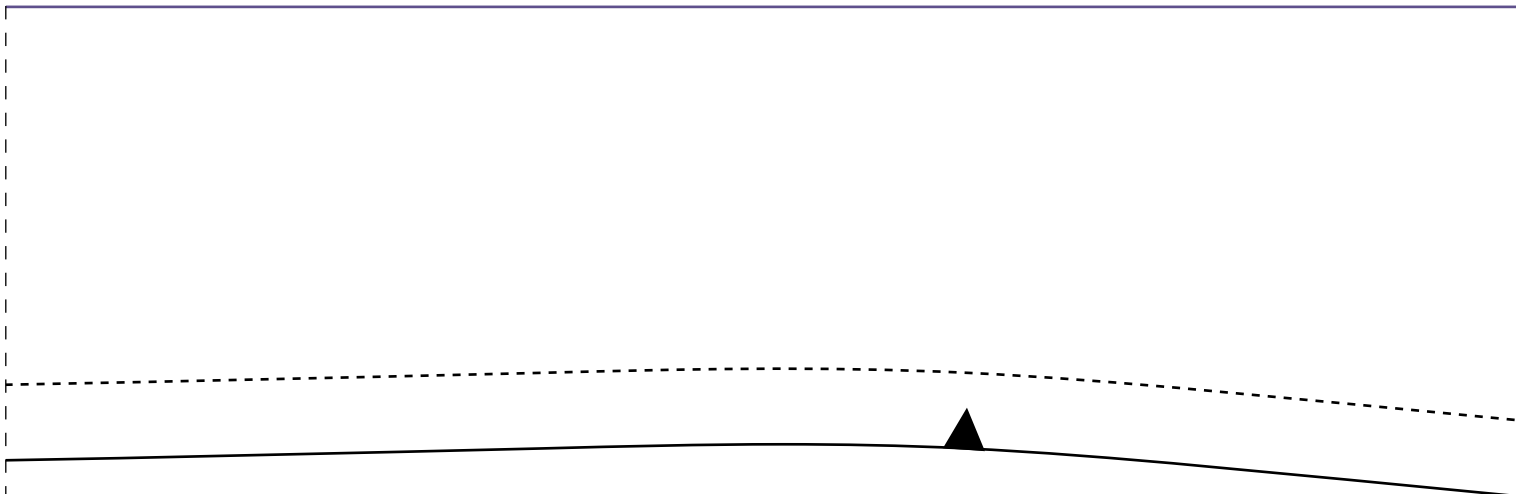

revel/frente 2x
42



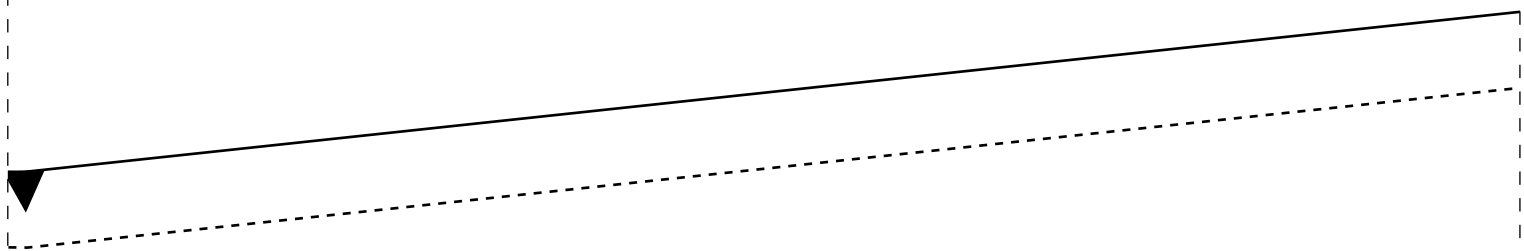

IDDED CD34

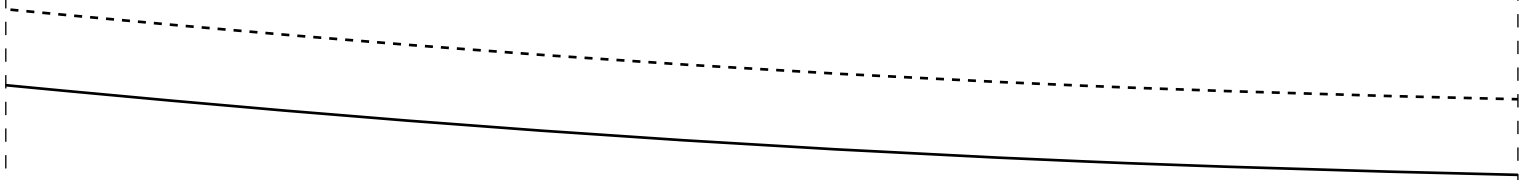

IDDED CD34



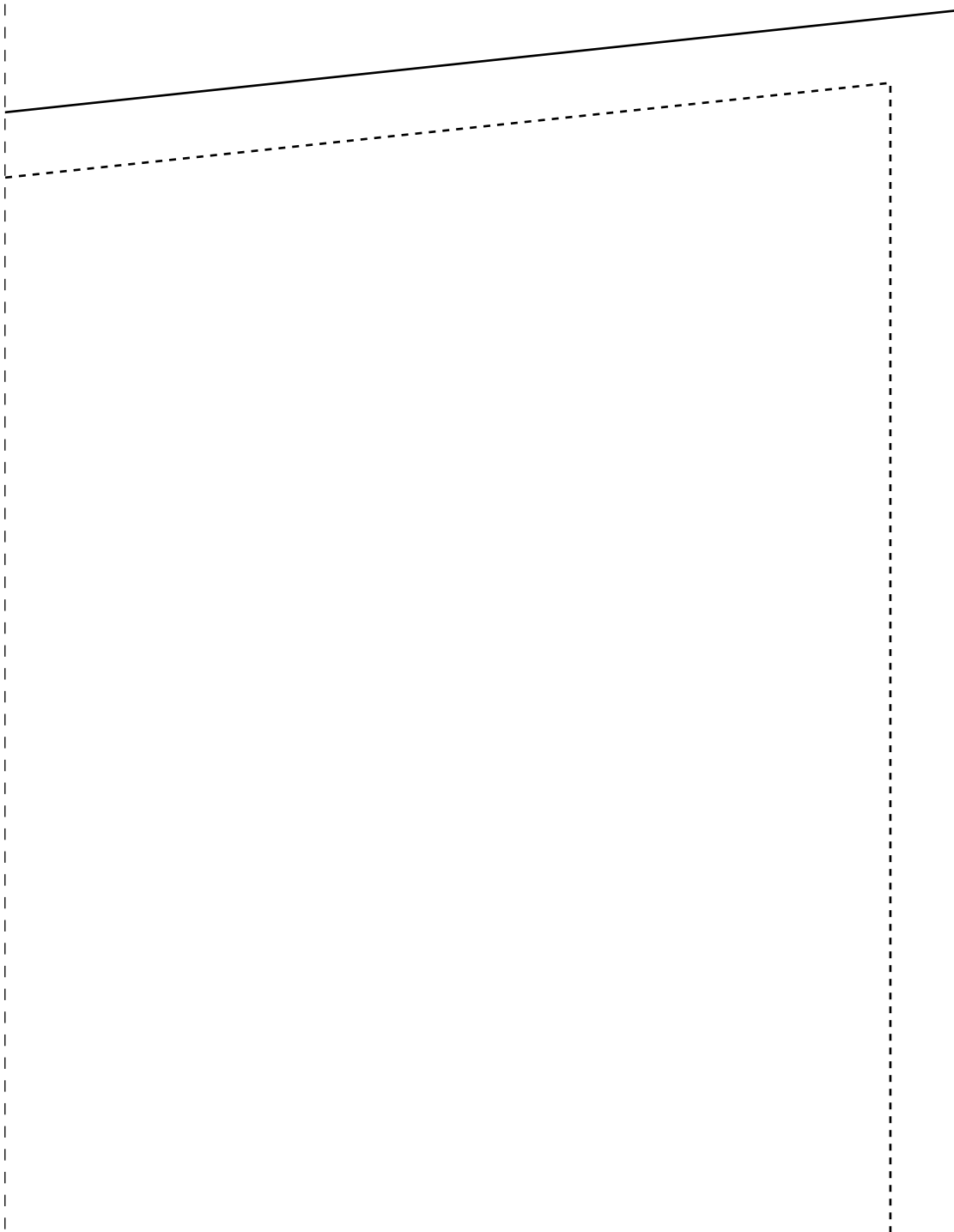

-

