

1-1

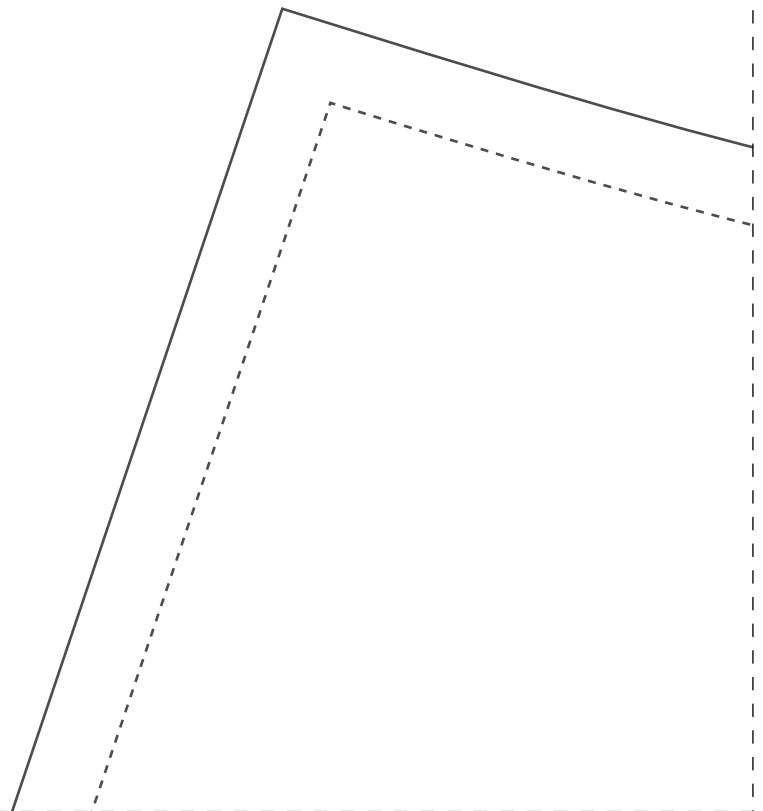

2-1

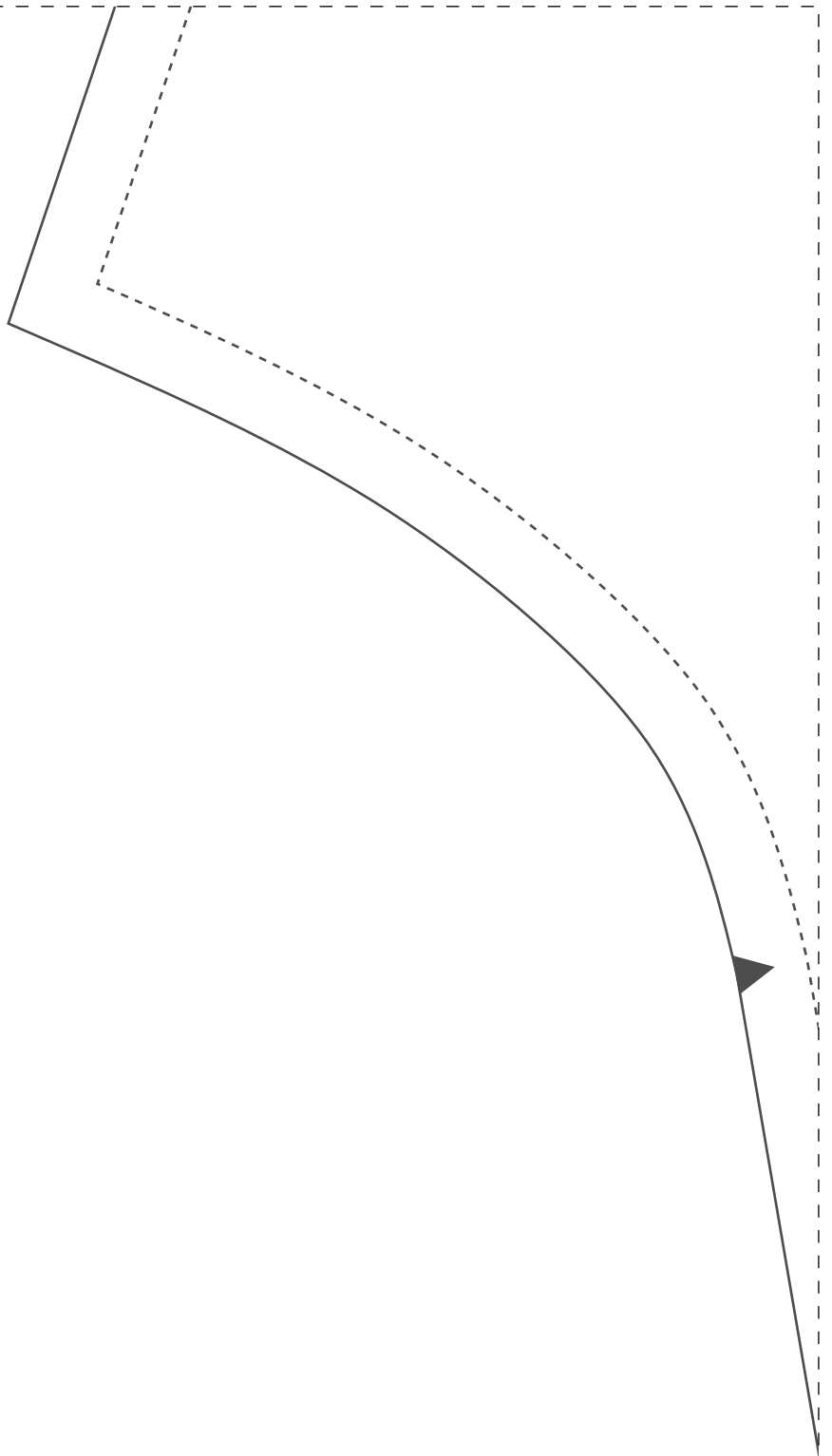

dobra

**IDDED CD34**

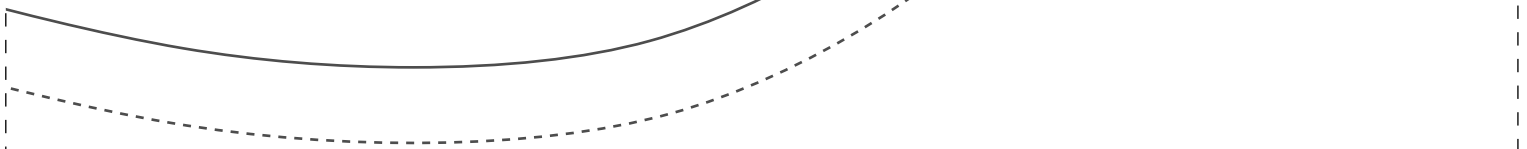

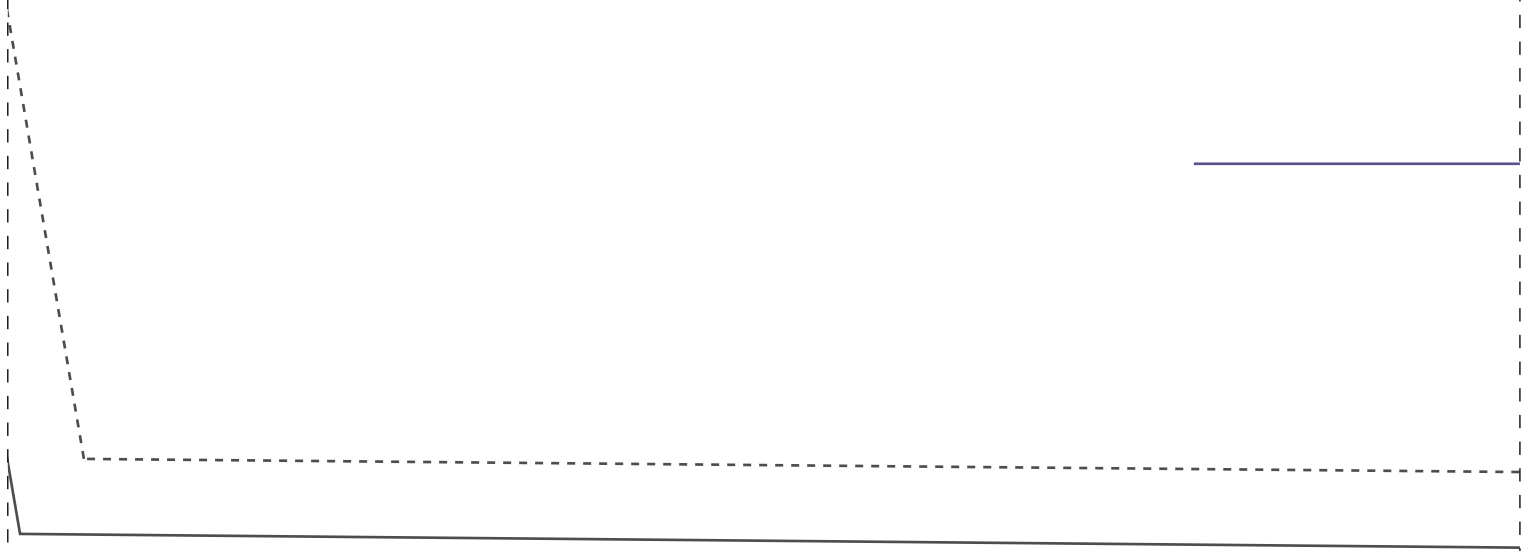

---

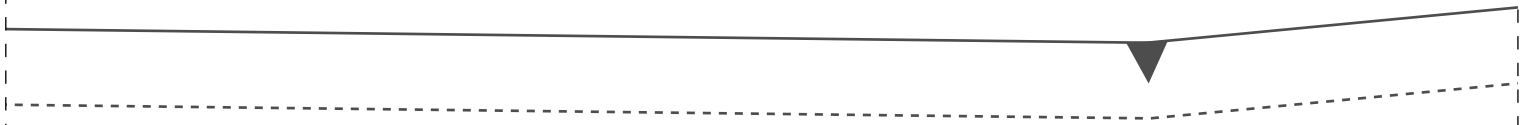

Instituto Diana Demarchi  
Escola de Costurar  
IDD Fashion Day  
Colete Feminino Alfaiataria

PROIBIDA REVENDA

frente 2x

46





cinto 2x  
46

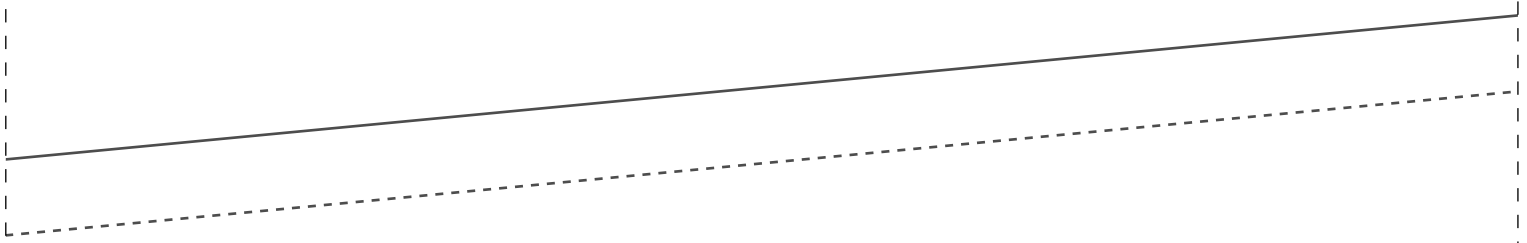

IDDED CD34





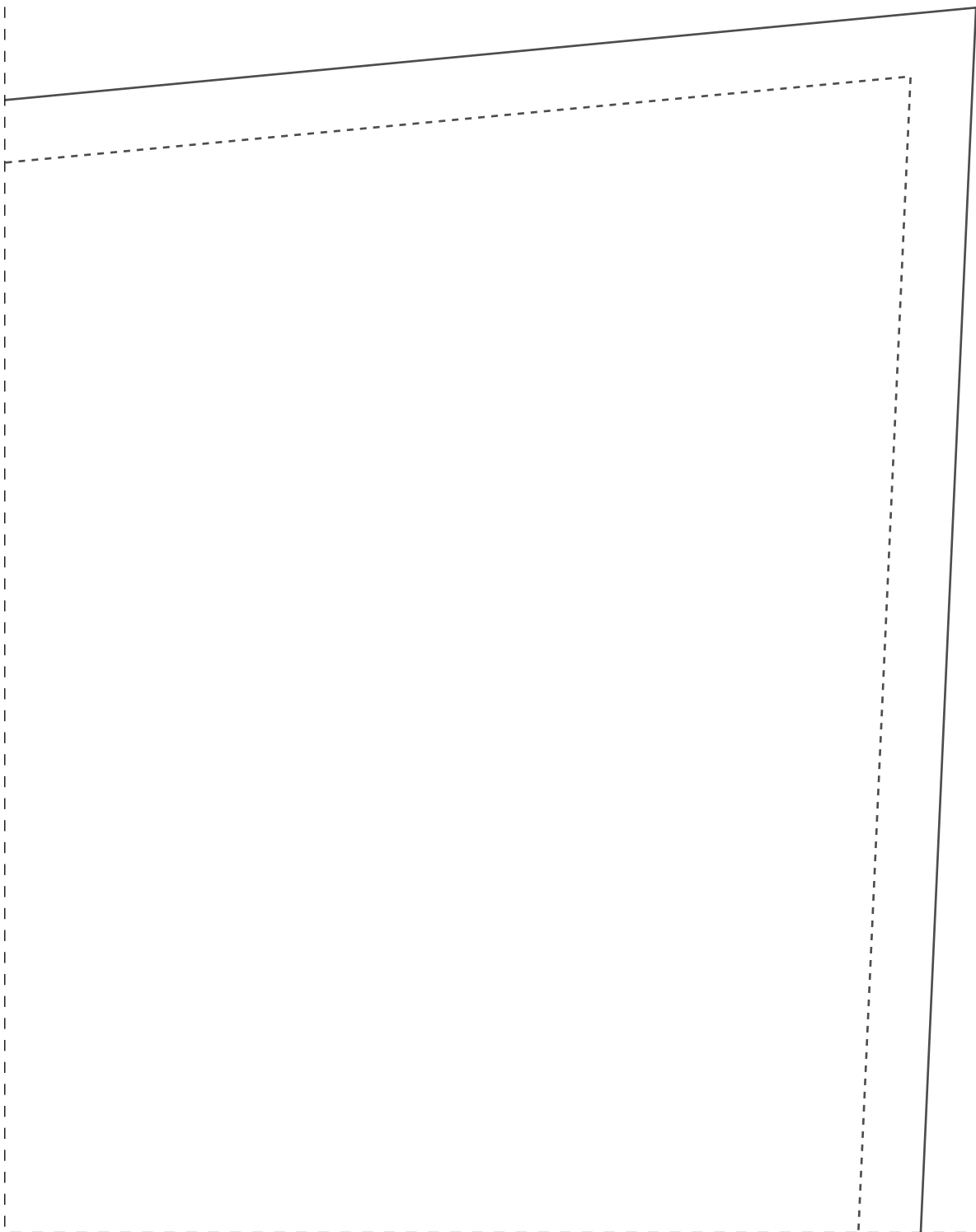

2-5



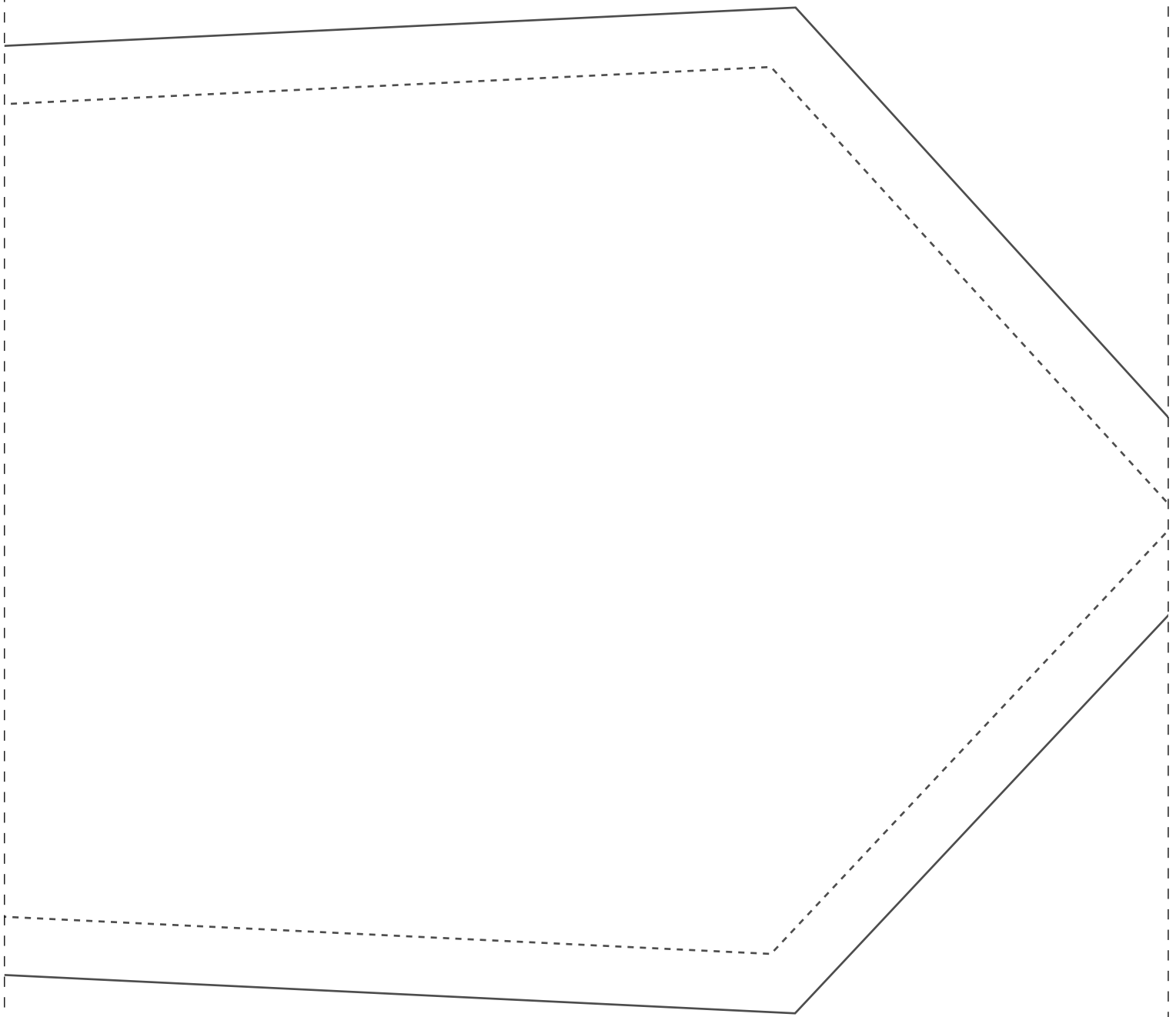

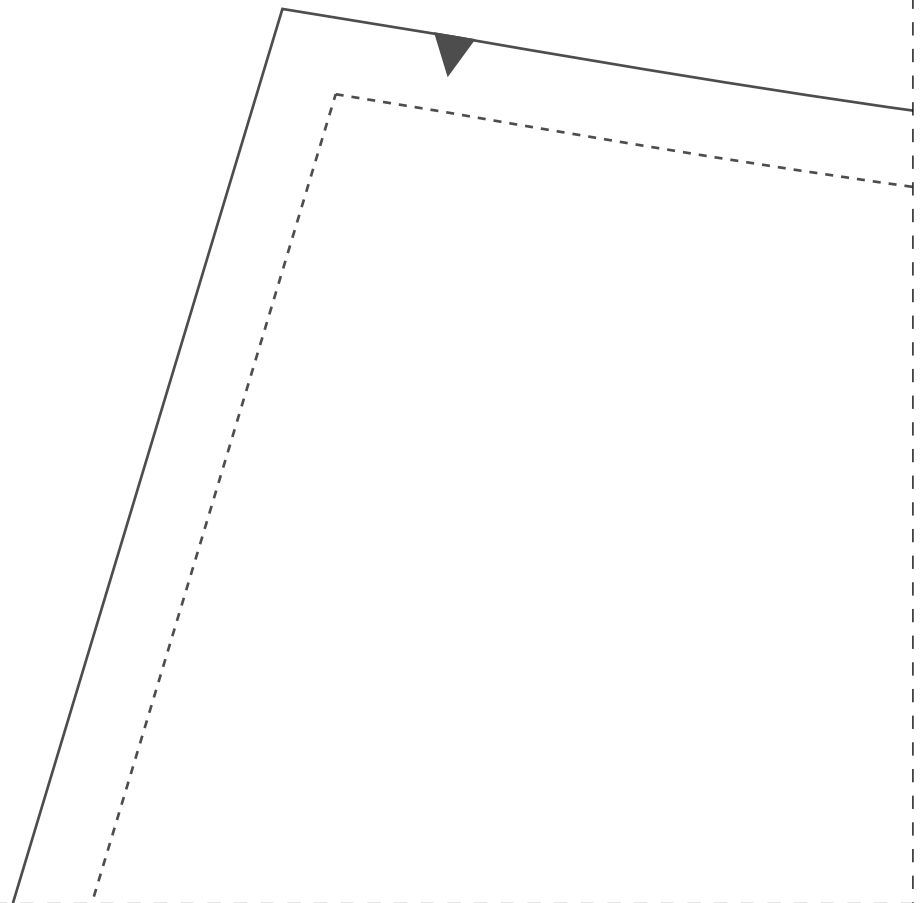



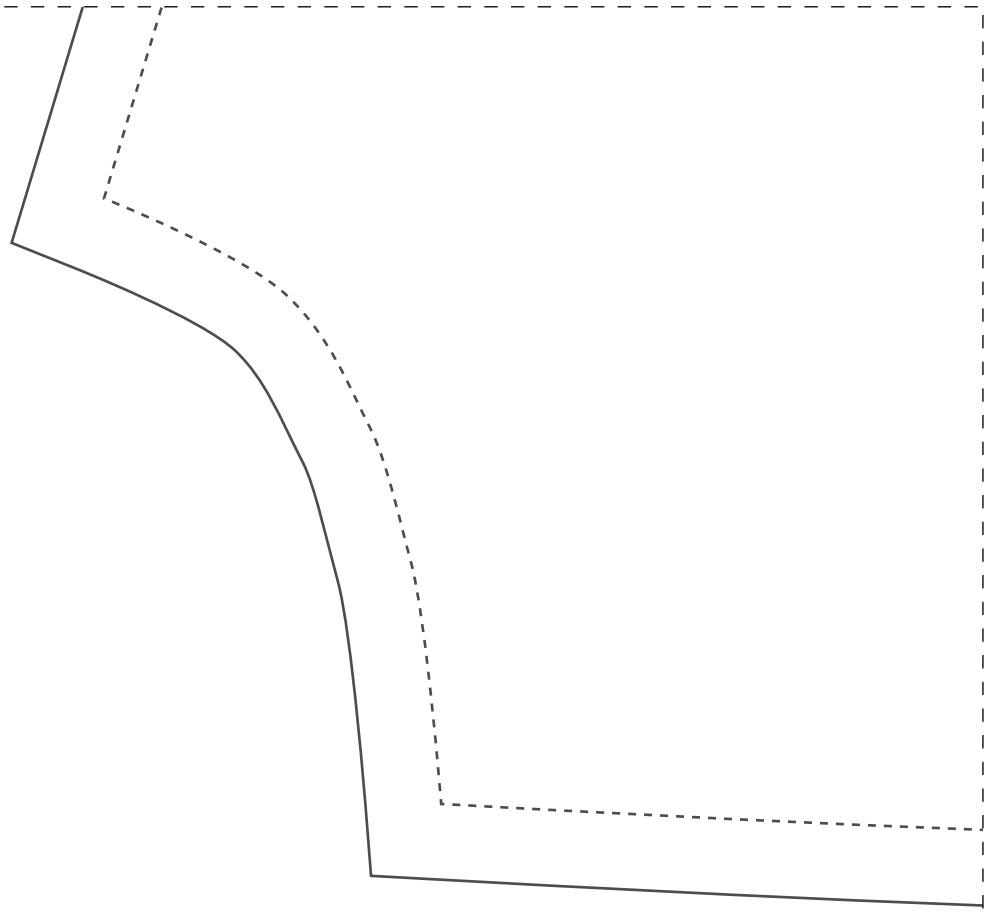

dobra

**IDDED CD34**

gola 2x

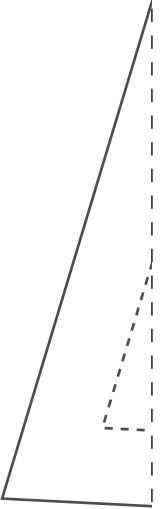
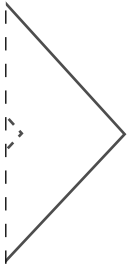

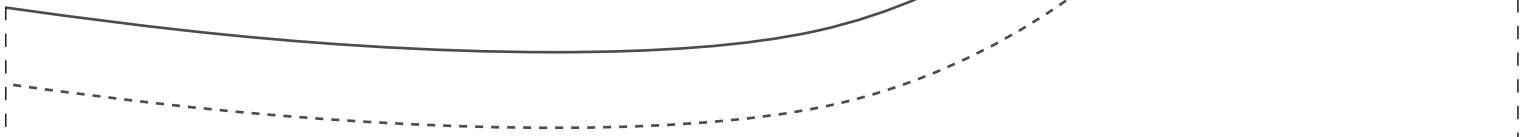

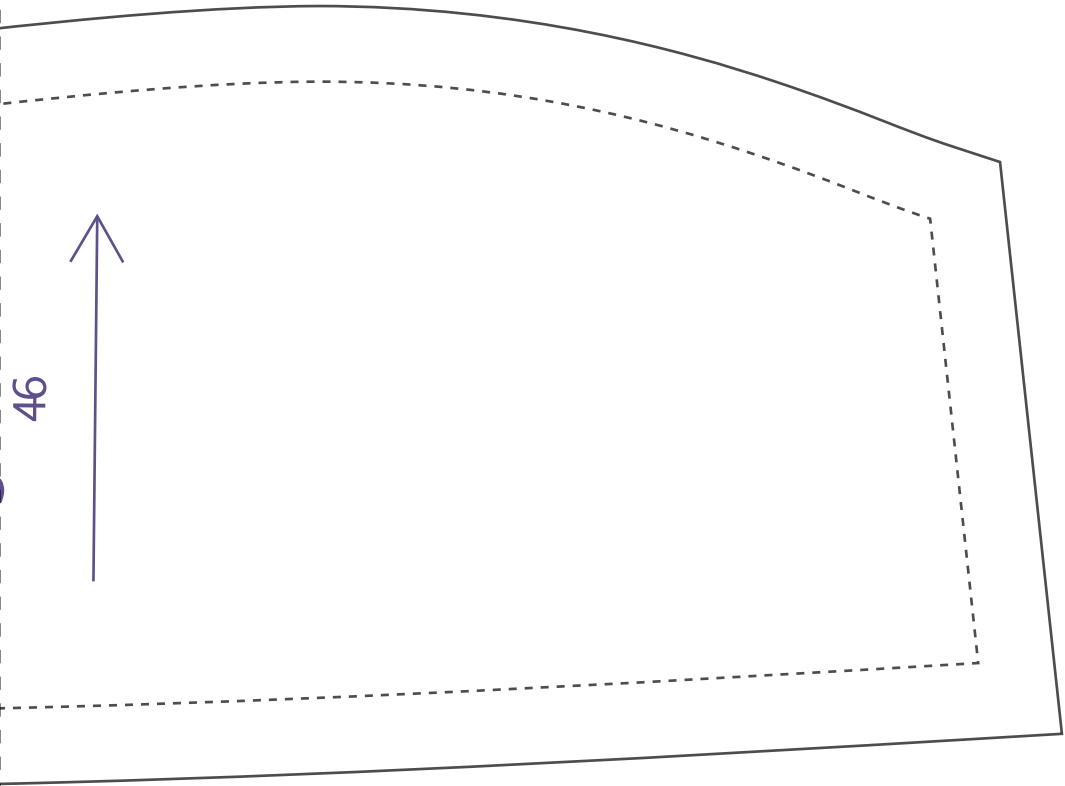

46

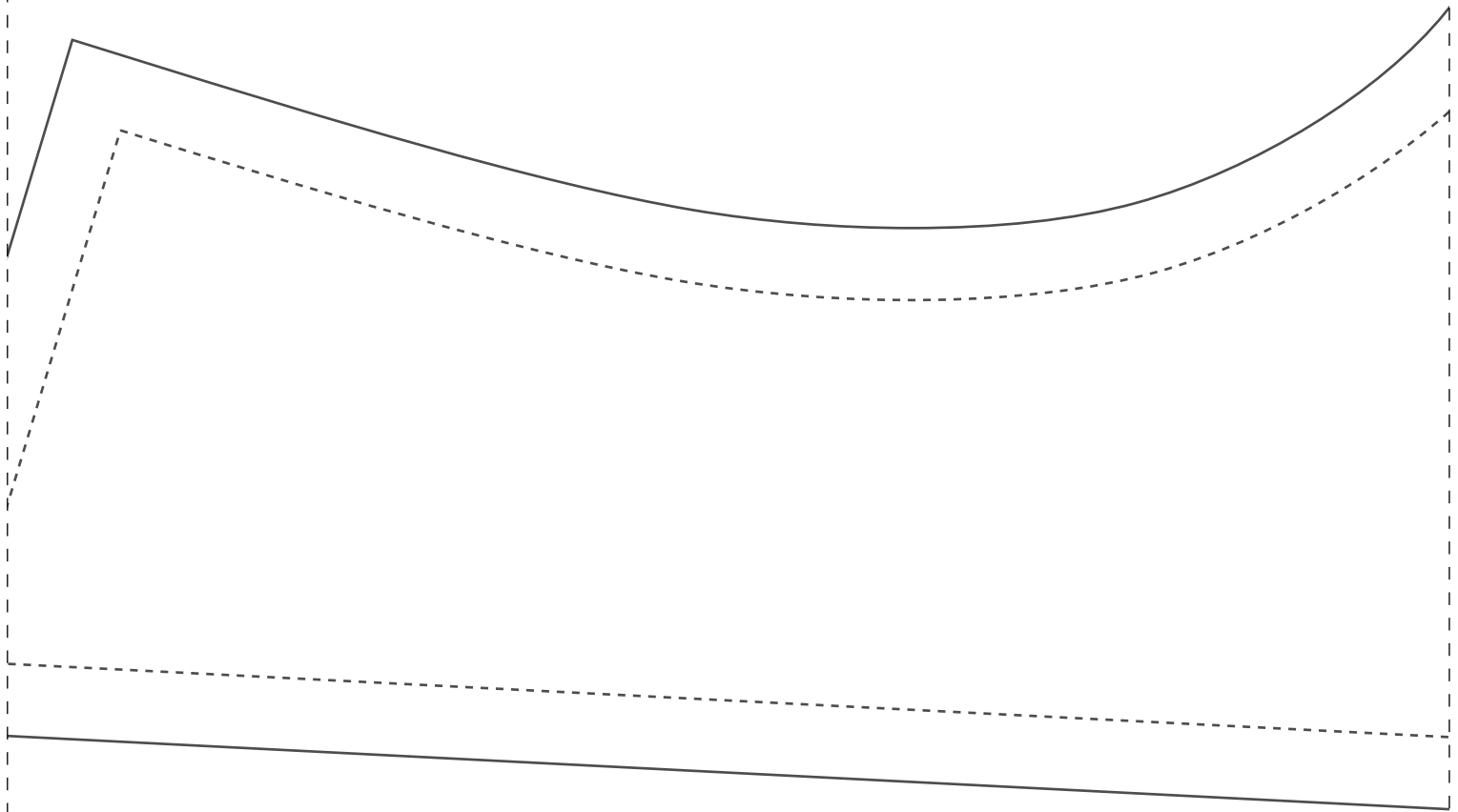

FICHA TÉCNICA:

TECIDO PLANO COM 1,4m DE LARGURA

-Linho, gabardine, alfaiataria  
ou similares

-Limpeza da peça com forro

-1,9m para os tamanhos 36 ao 42

-2,3m para os tamanhos 44 ao 54

-Forro: 1m para todos os tamanhos

costas 2x  
46

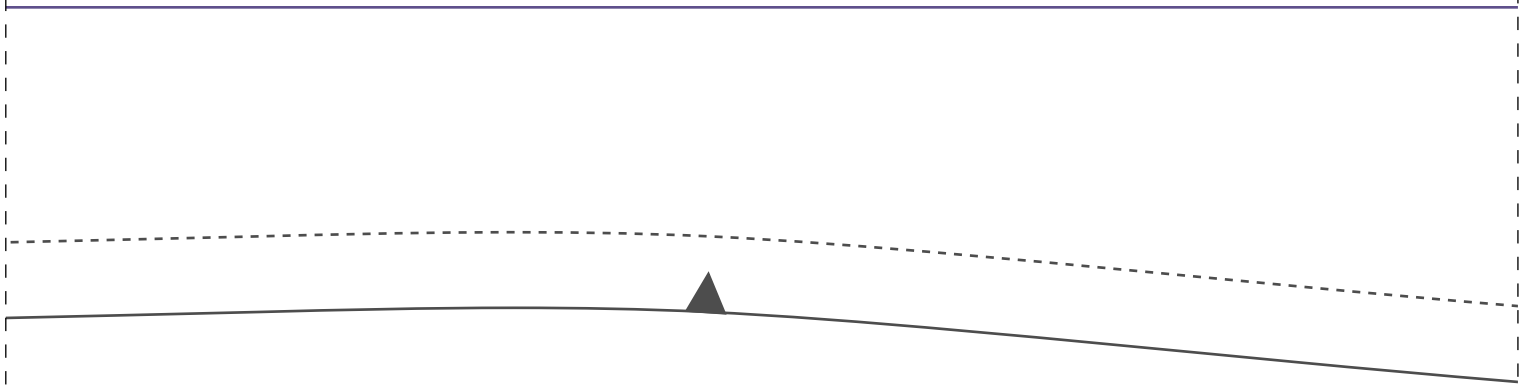

3-8

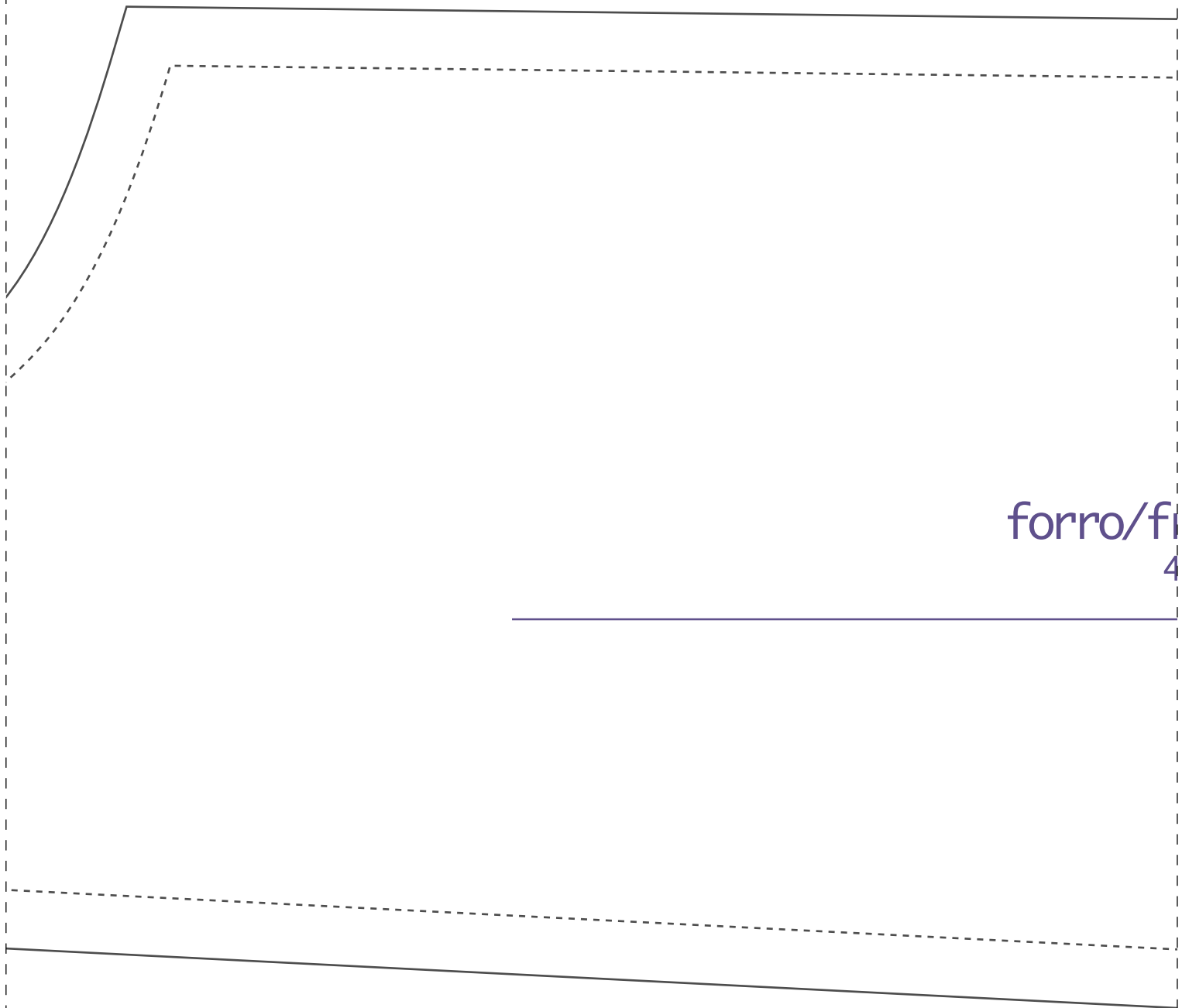

forro/fi  
4



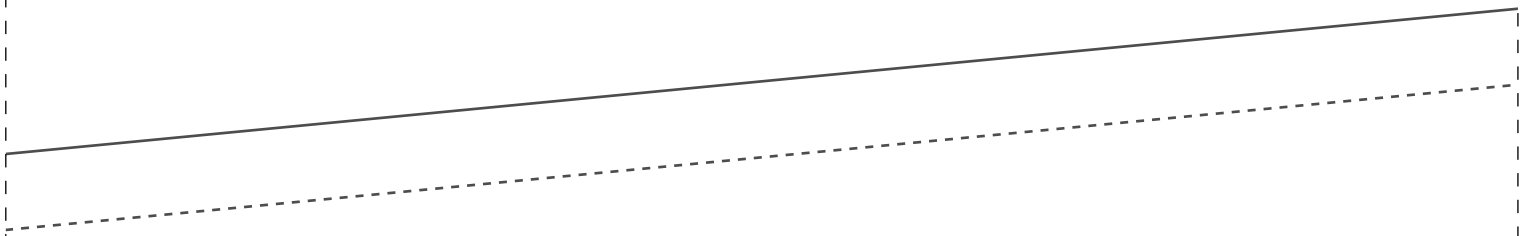

IDDED CD34

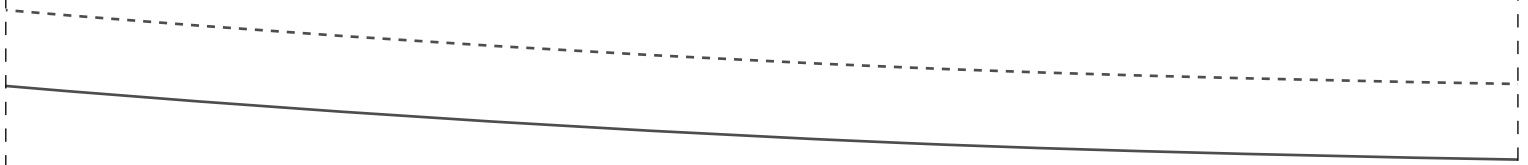

3-9

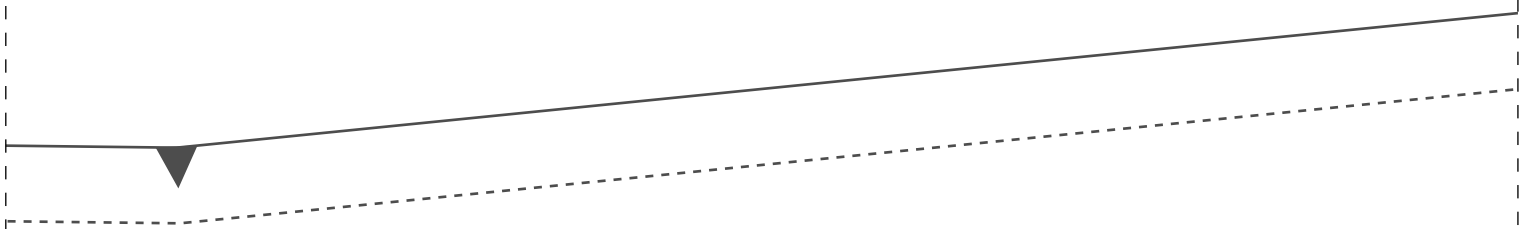

rente 2x  
6

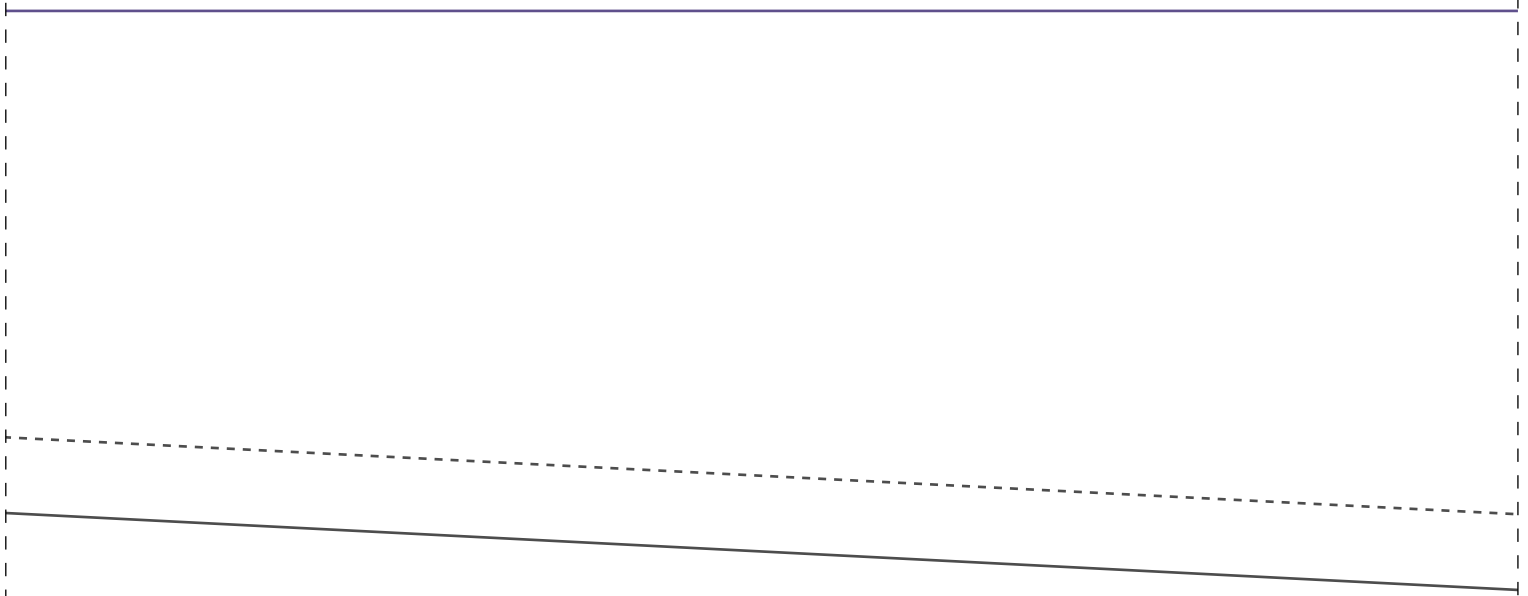

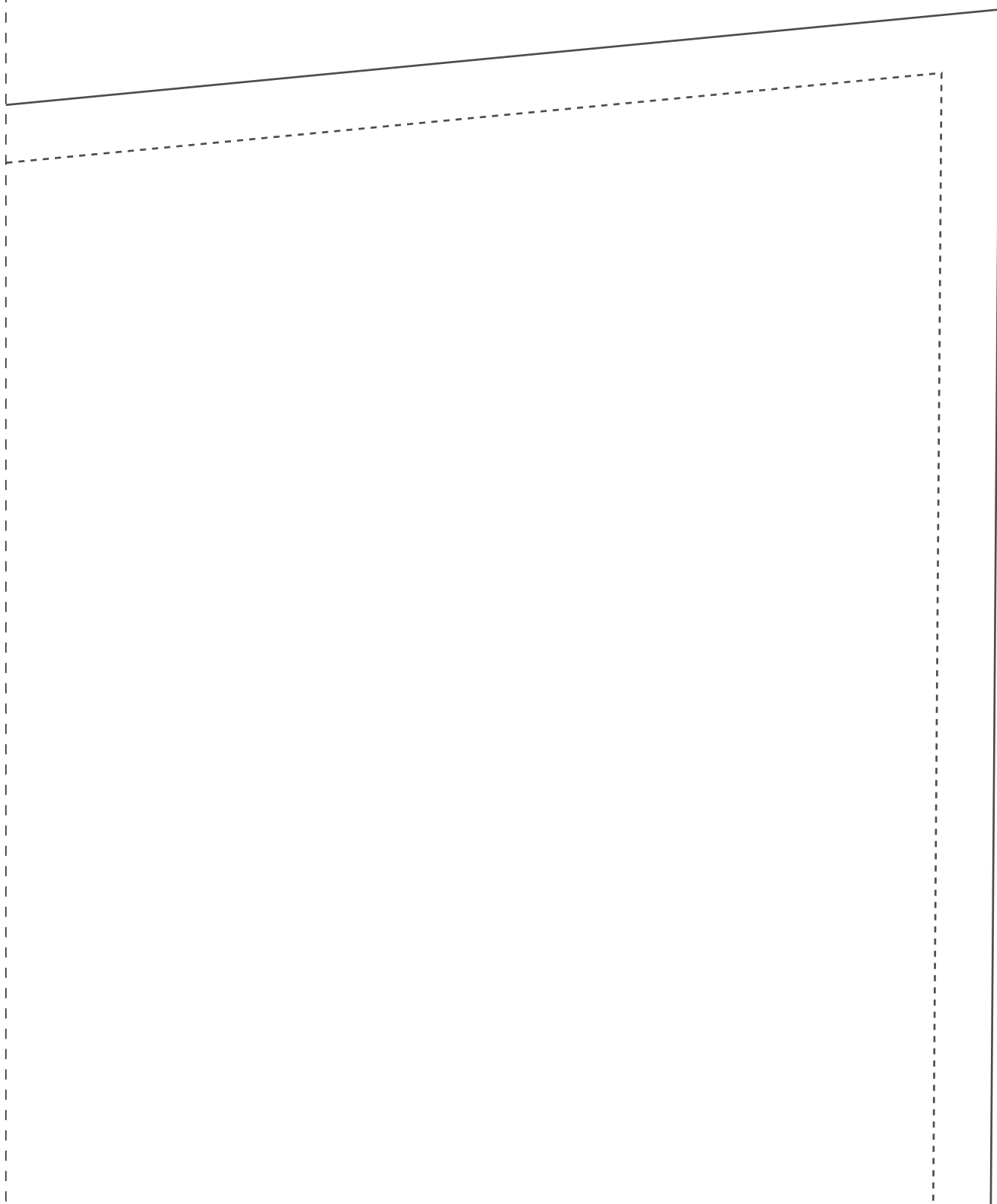



3-10

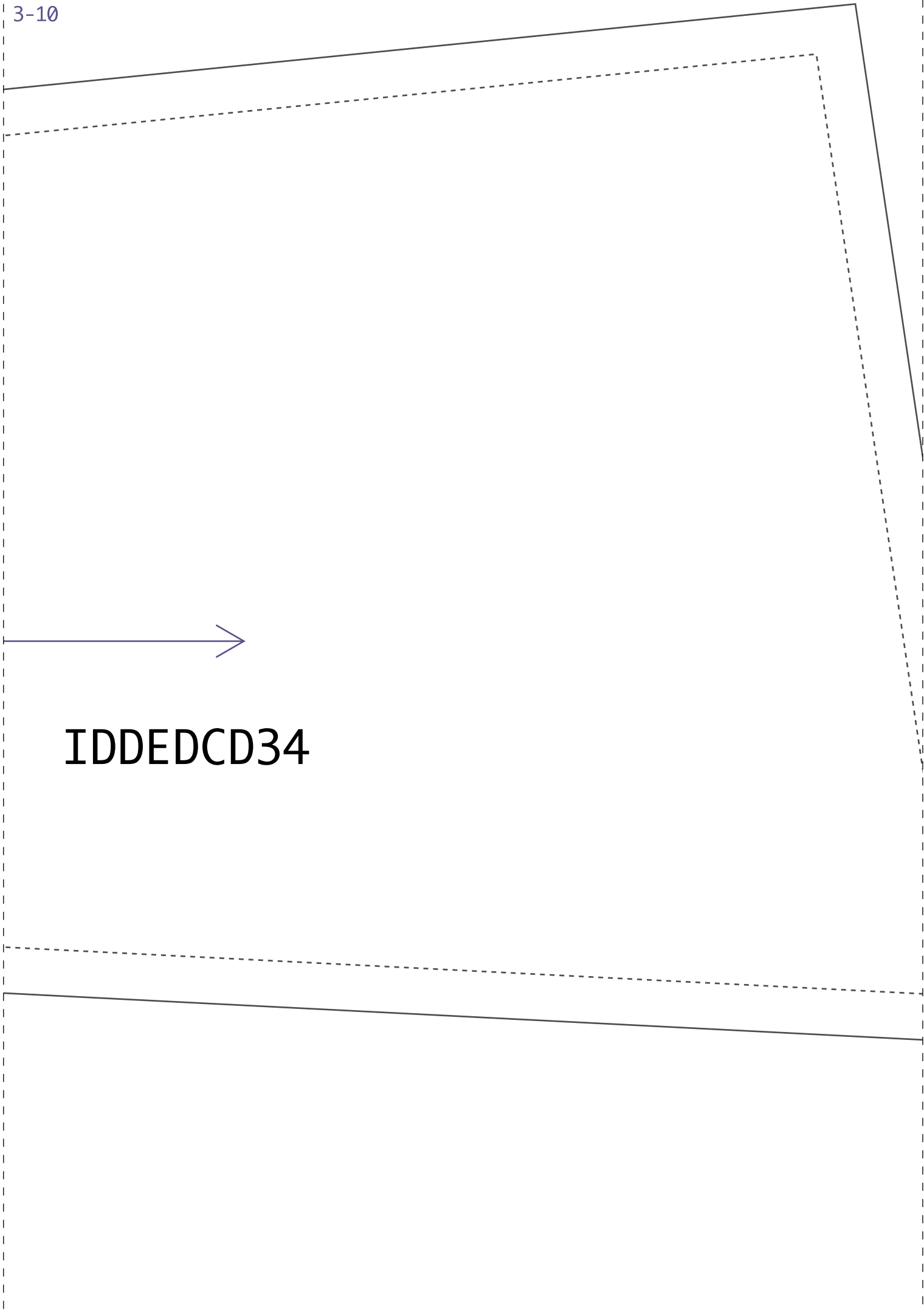

**IDDED CD34**

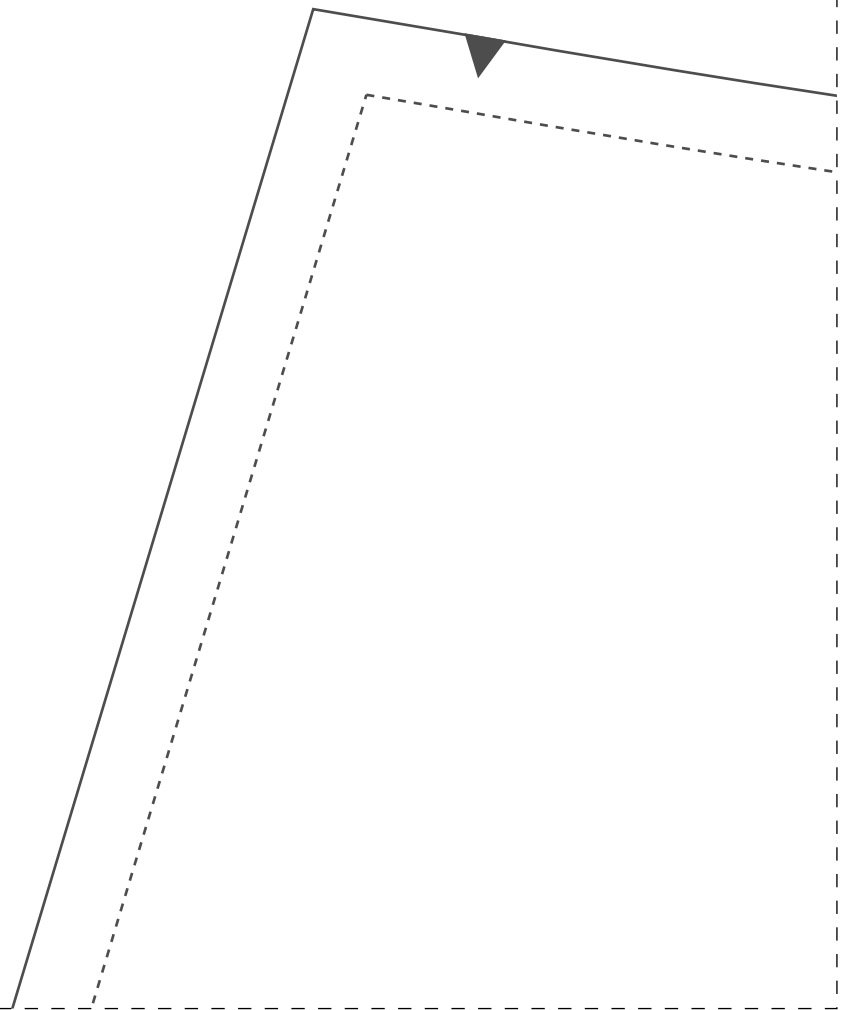

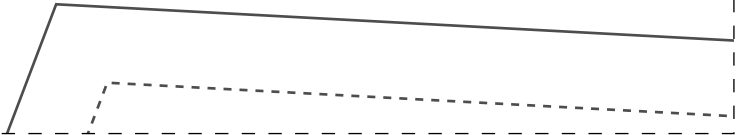
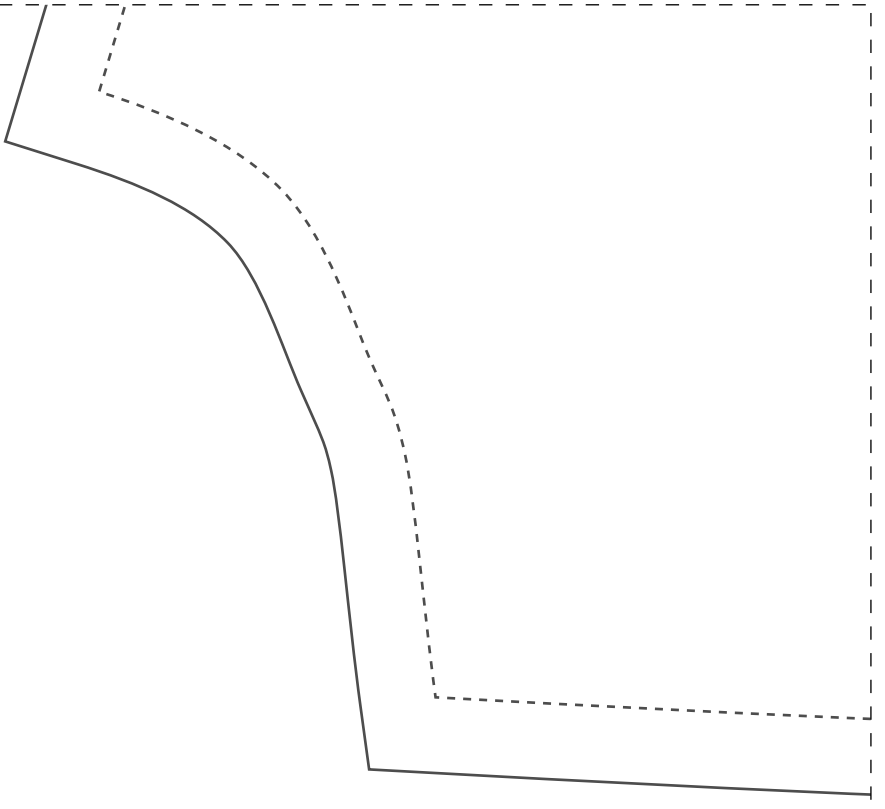



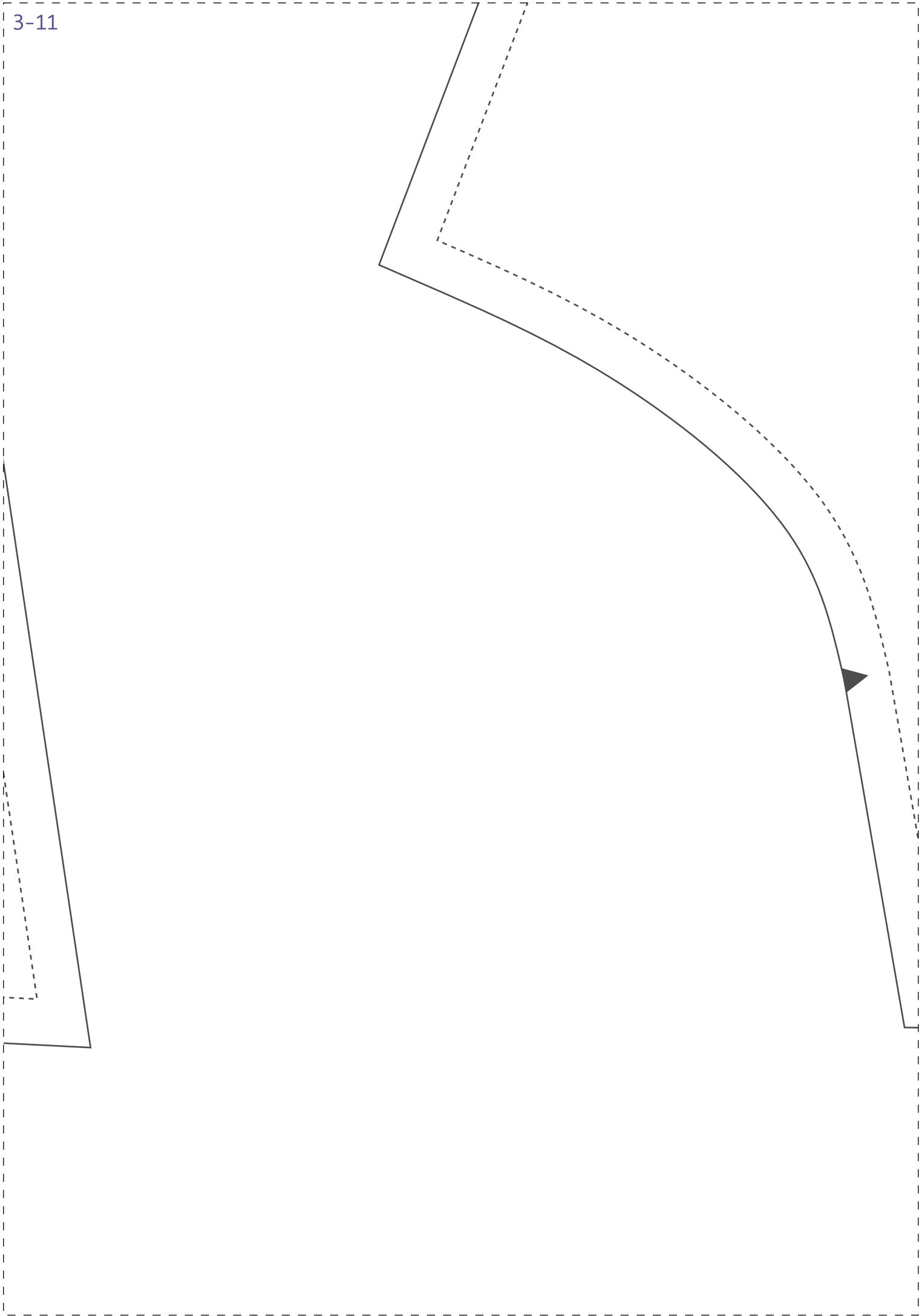

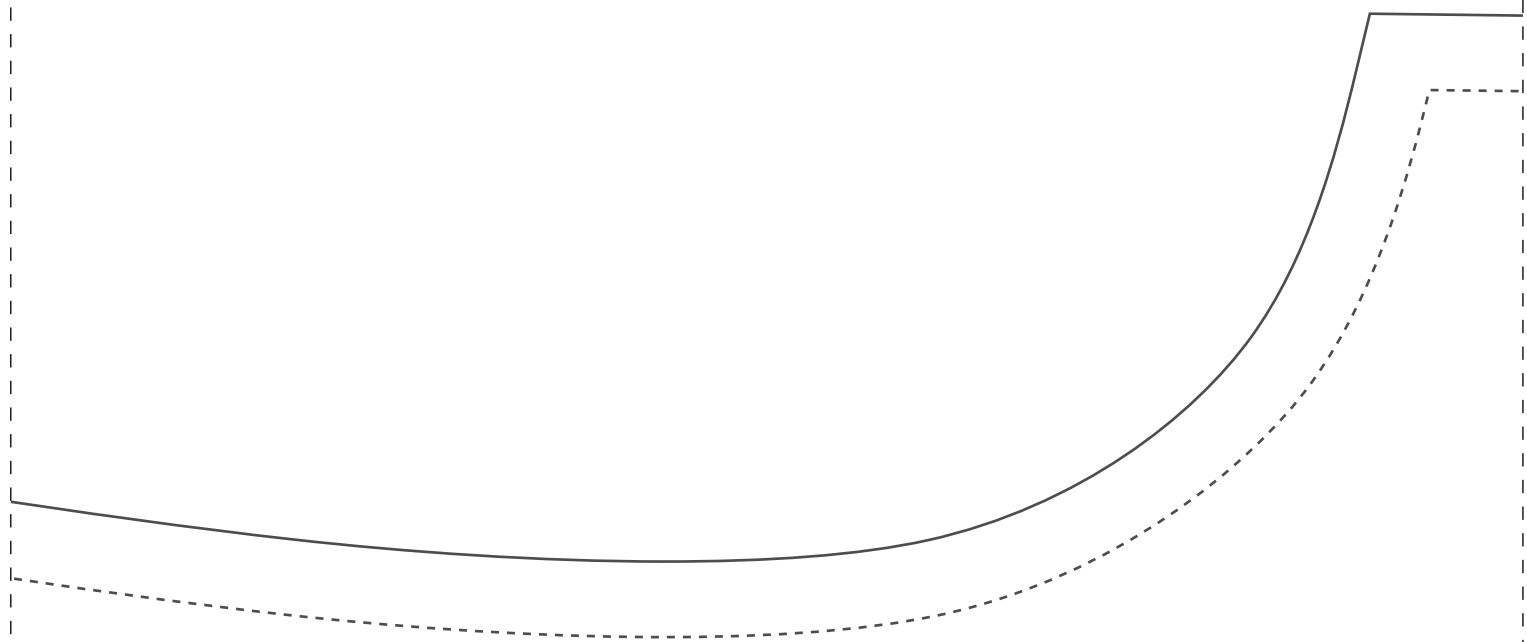

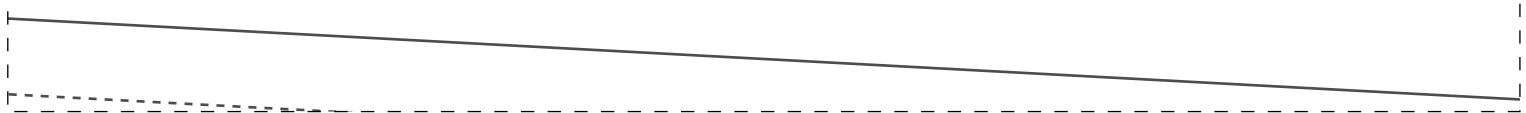

---

---

Instituto Diana Demarchi  
Escola de Costurar  
IDD Fashion Day  
Colete Feminino Alfaiataria

**PROIBIDA REVENDA**

forro/costas 2x  
46

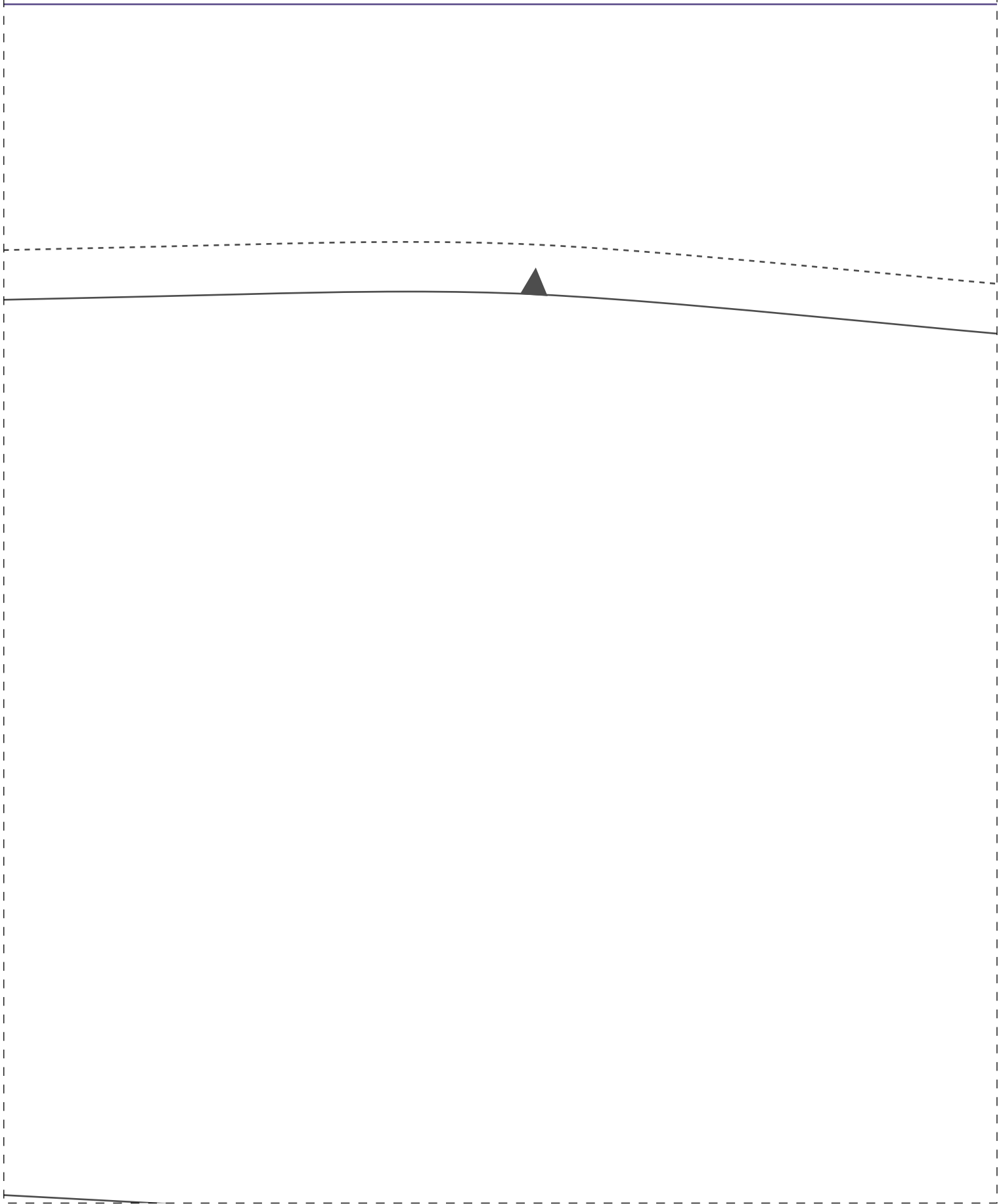

revel/frente 2x  
46



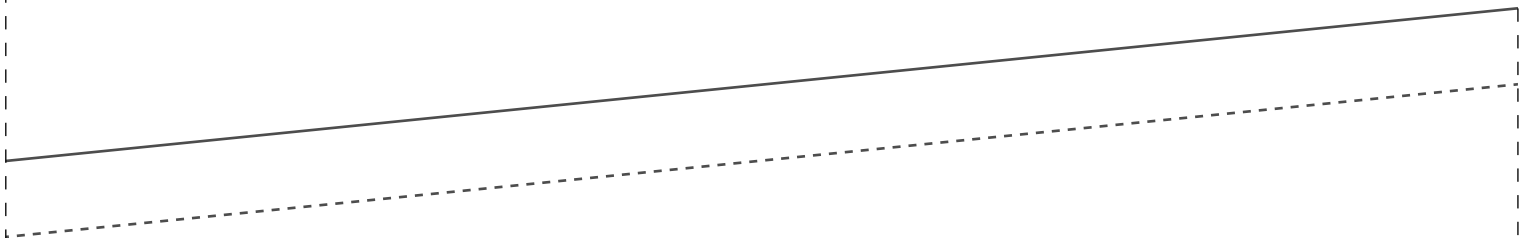



IDDED CD34

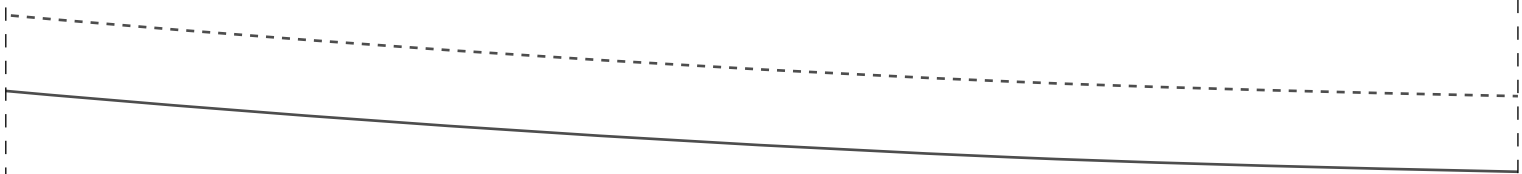

3-14

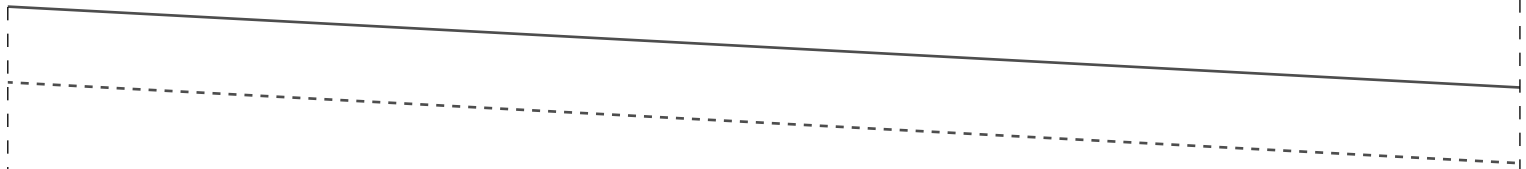

**IDDED CD34**



-

