

1-1

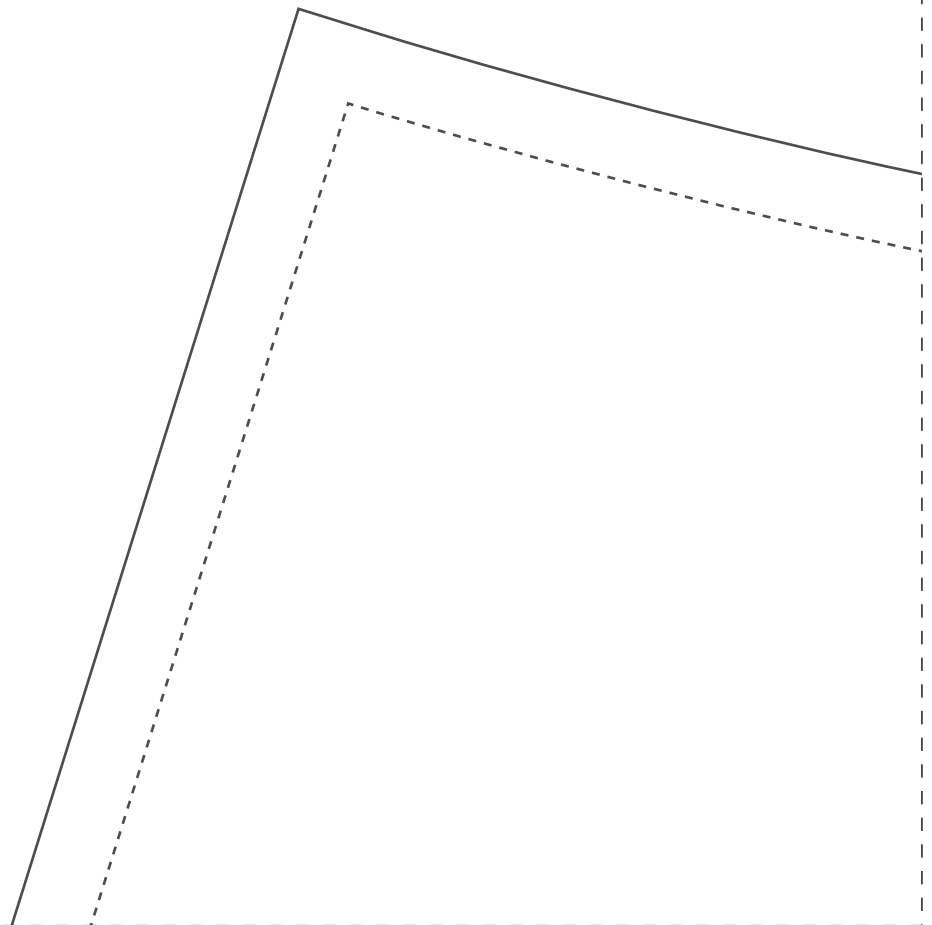

2-1

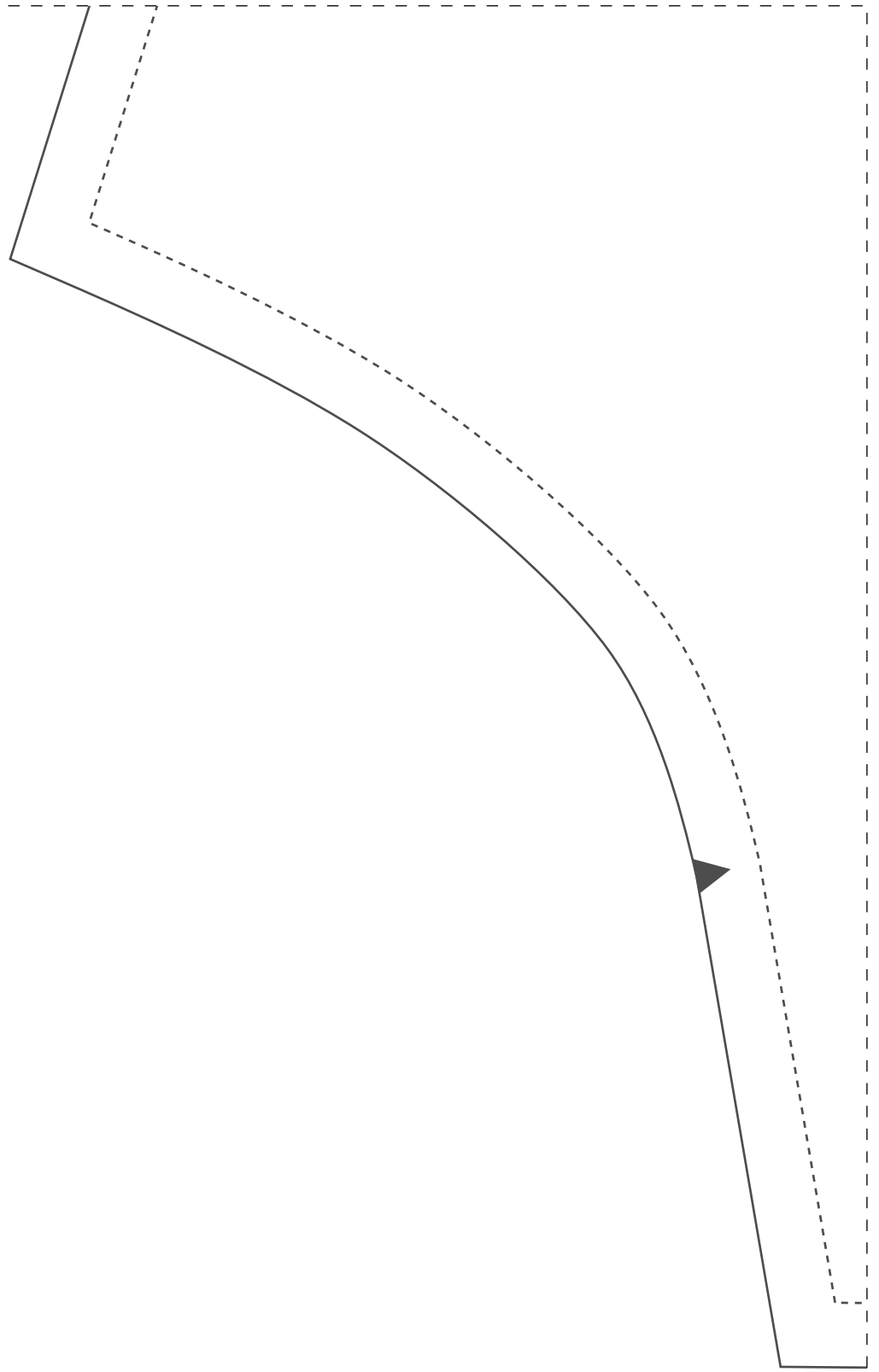

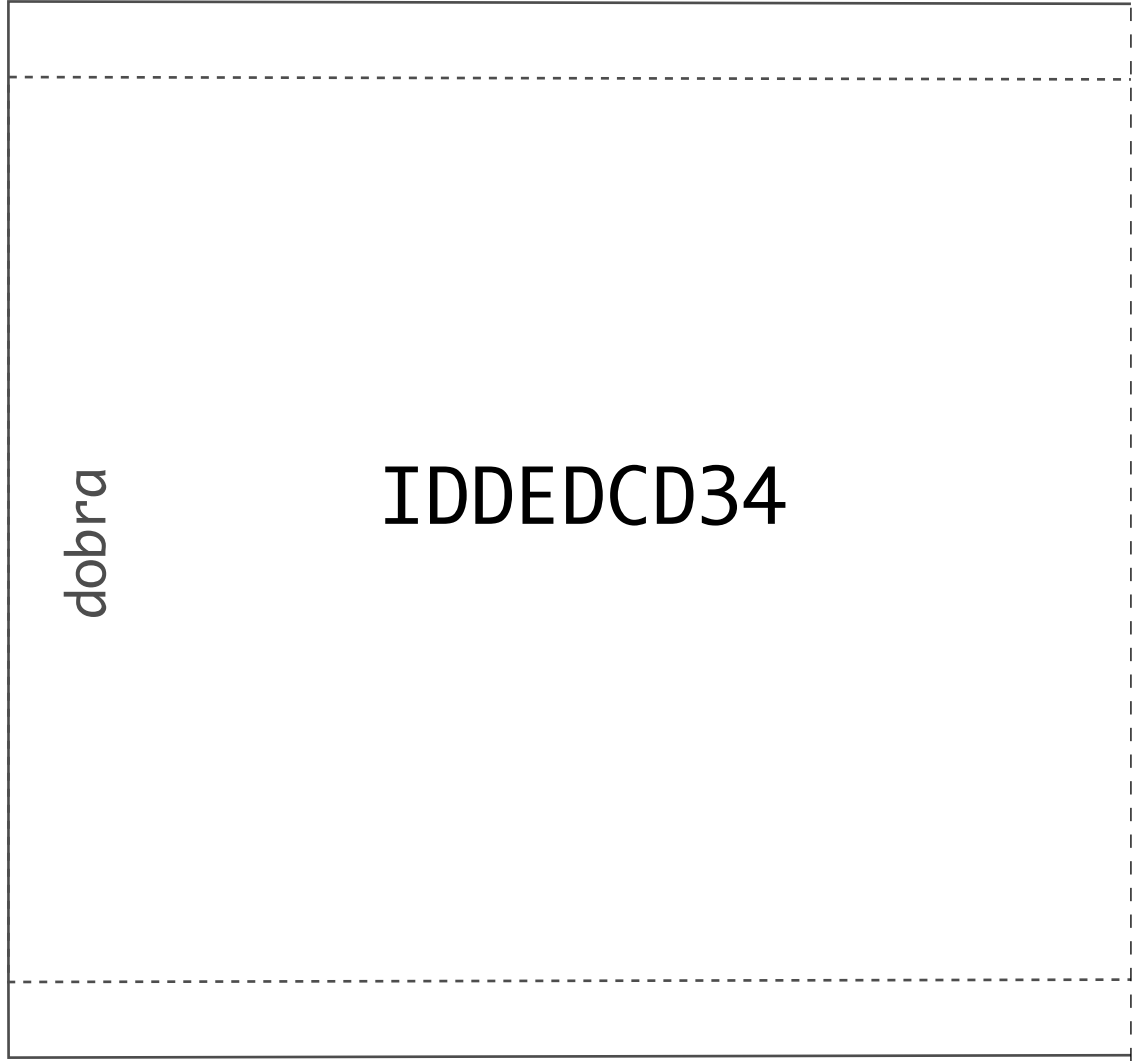

dobra

IDDED CD34

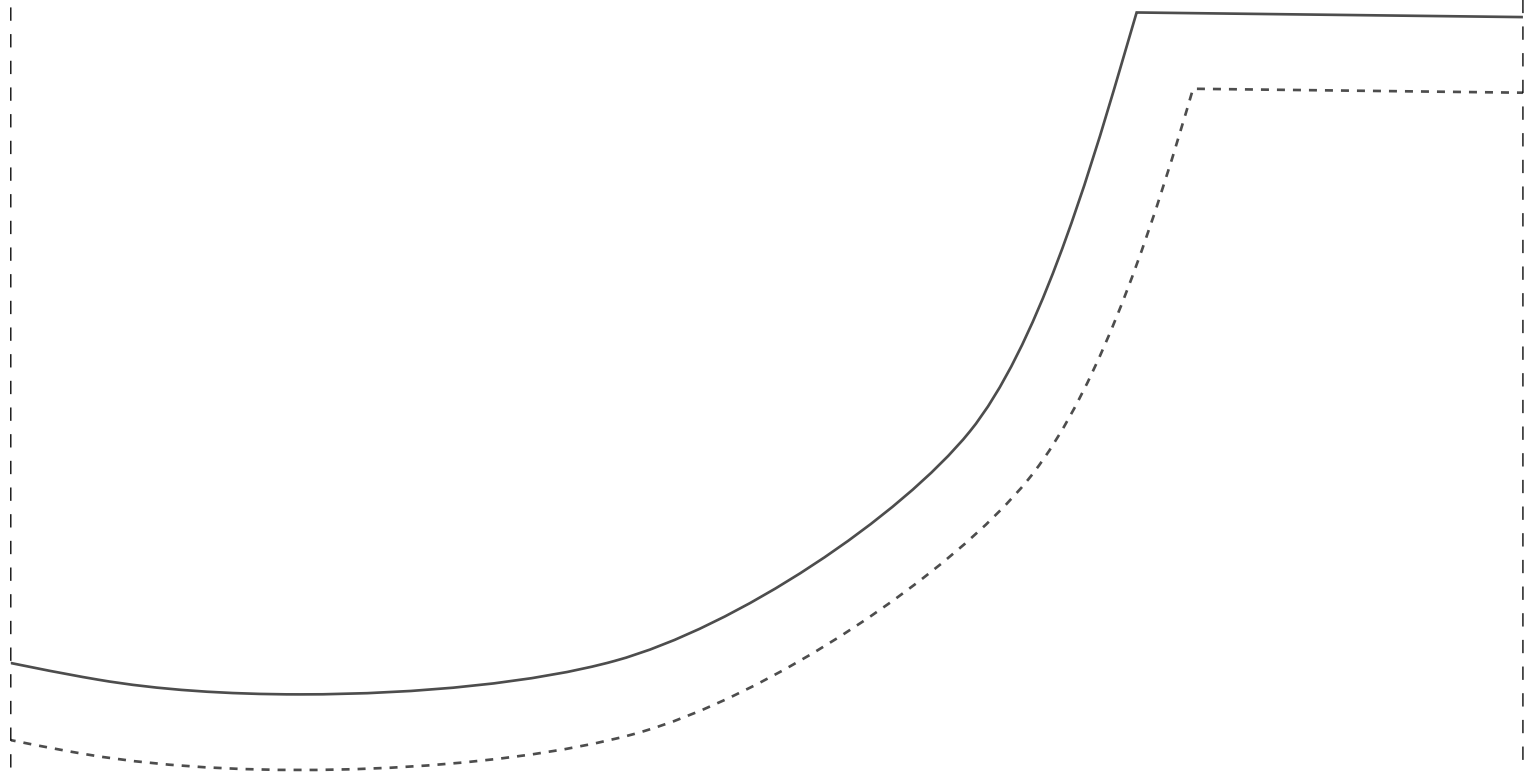





Instituto Diana Demarchi
Escola de Costurar
IDD Fashion Day
Colete Feminino Alfaiataria

PROIBIDA REVENDA

frente 2x

50



cinto 2x
50

1-4

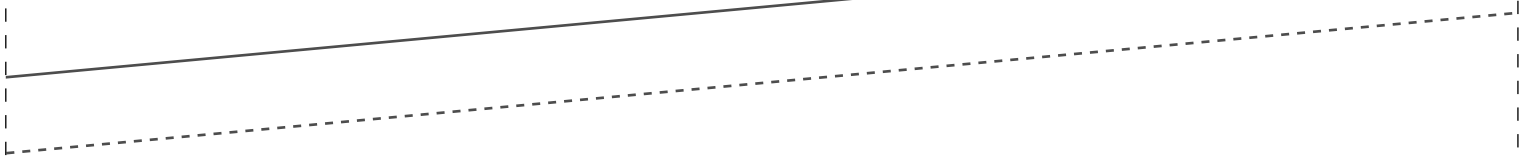
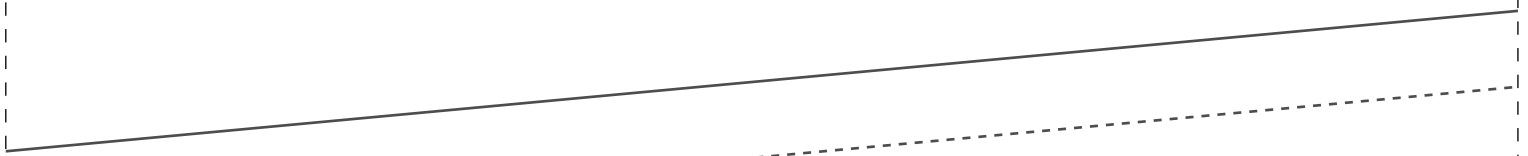

IDDED CD34



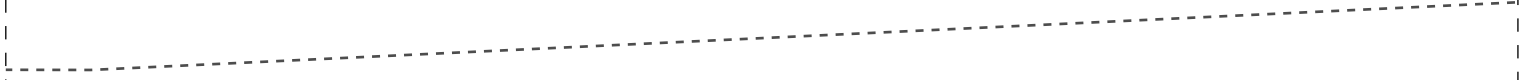

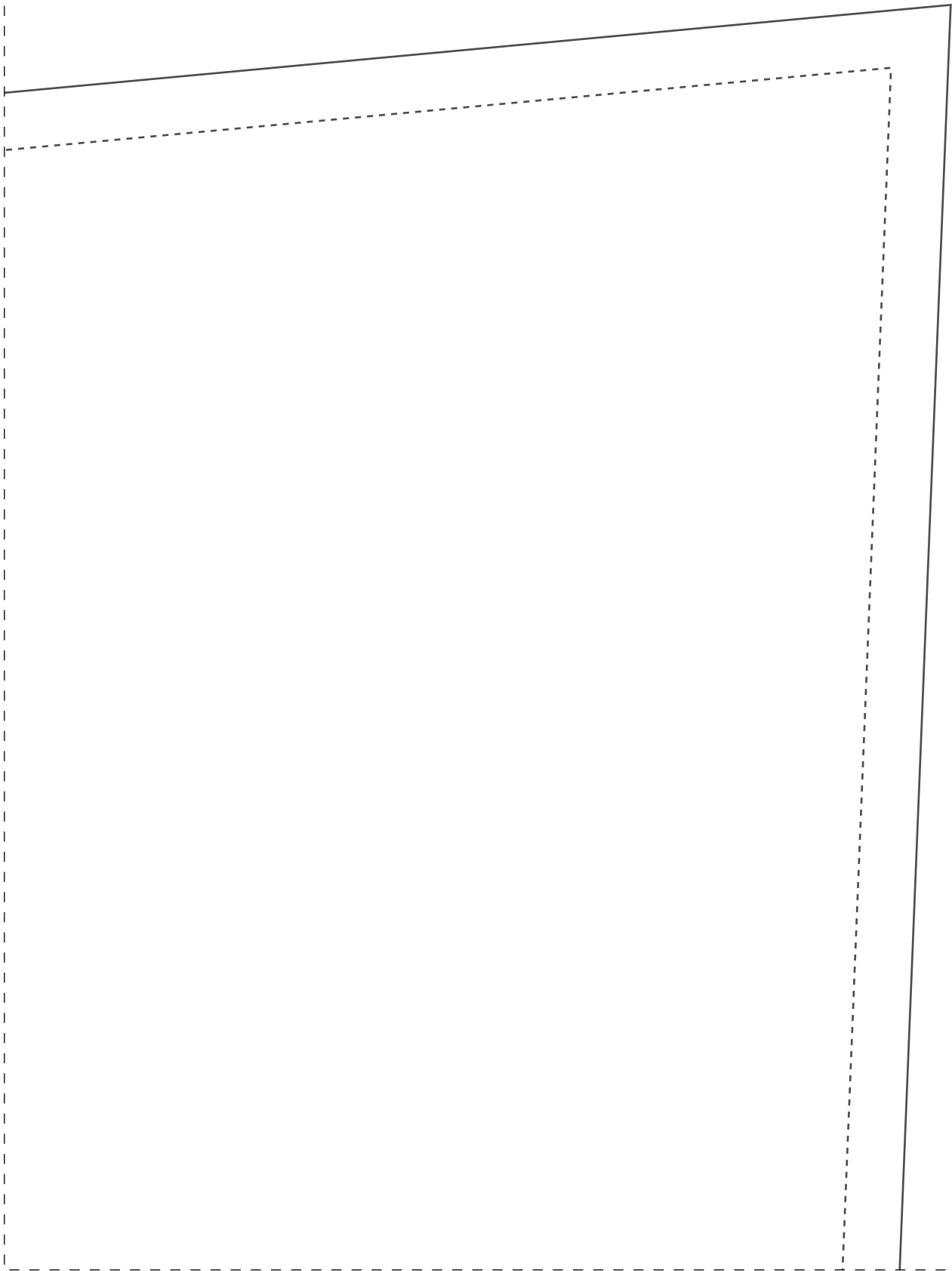

2-5



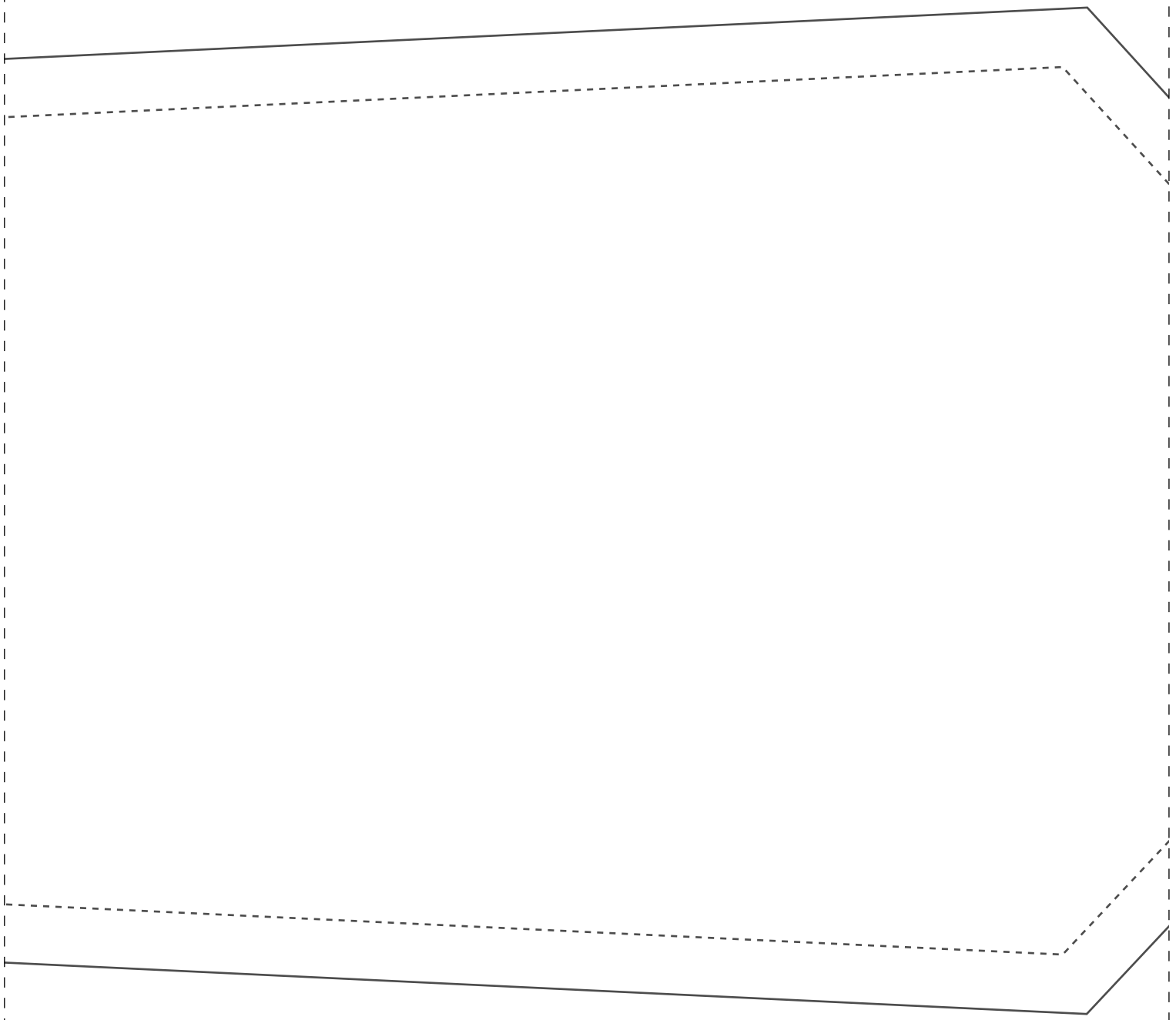

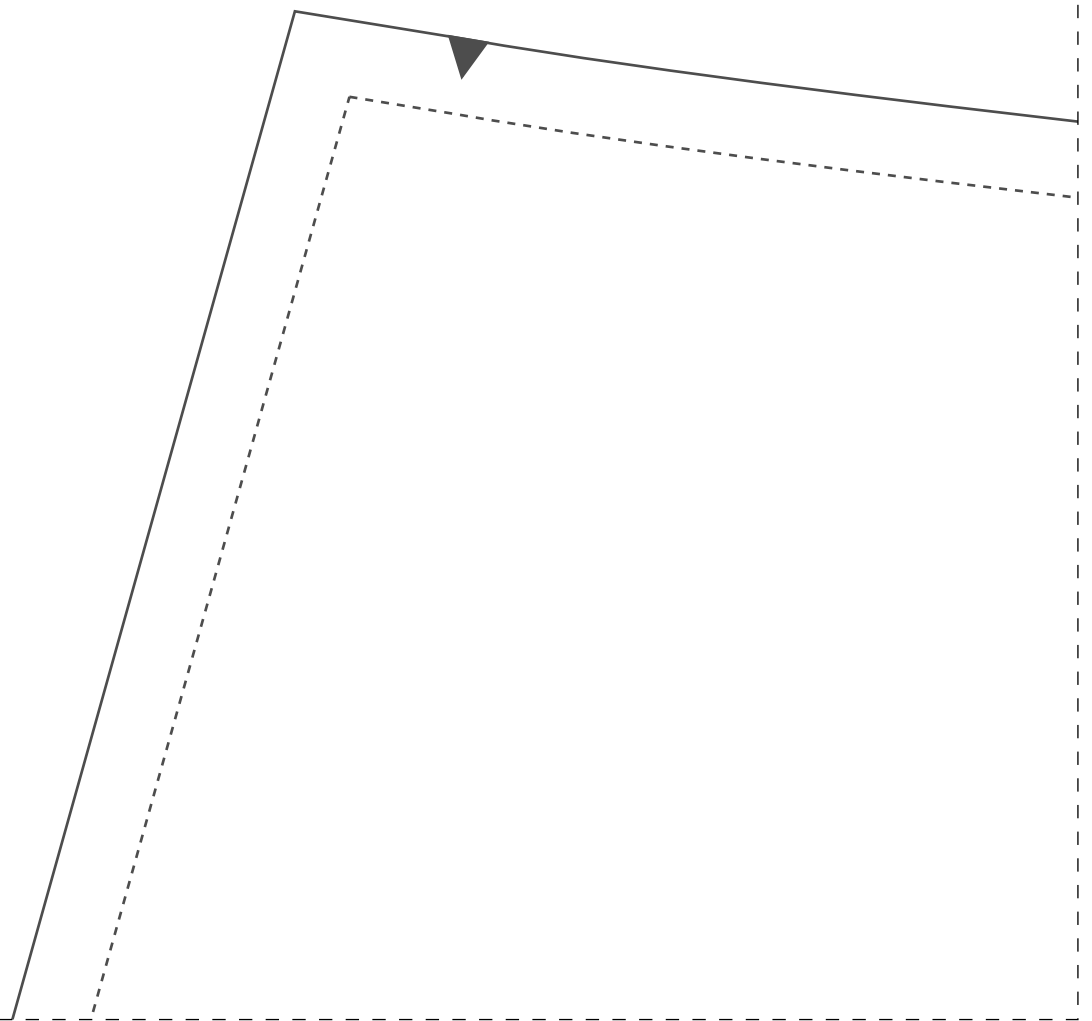

3-6

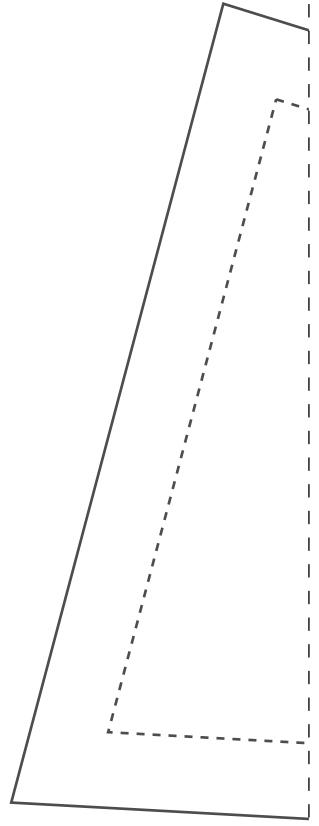
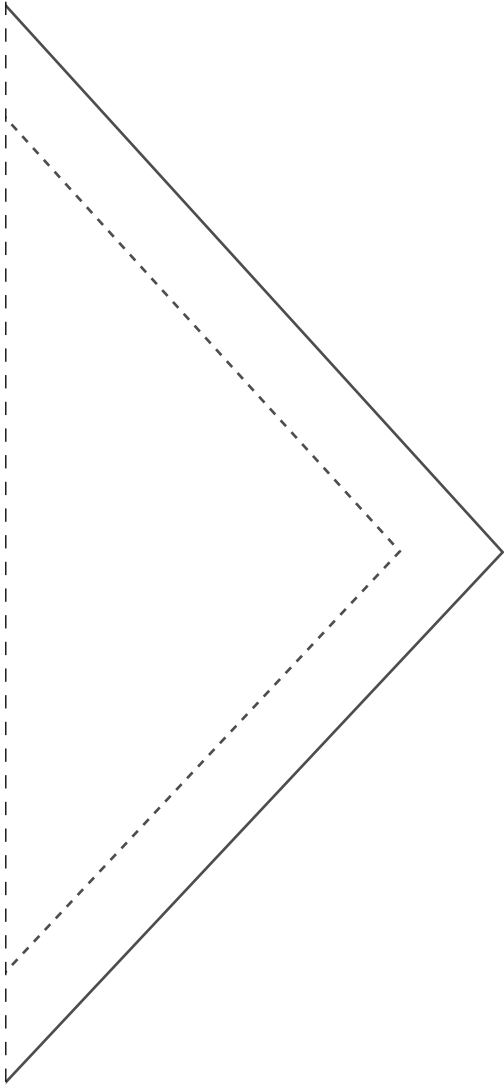

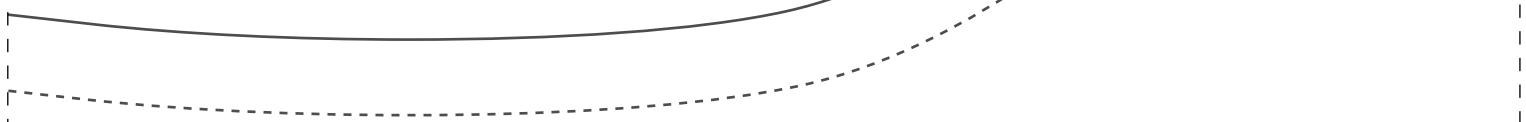

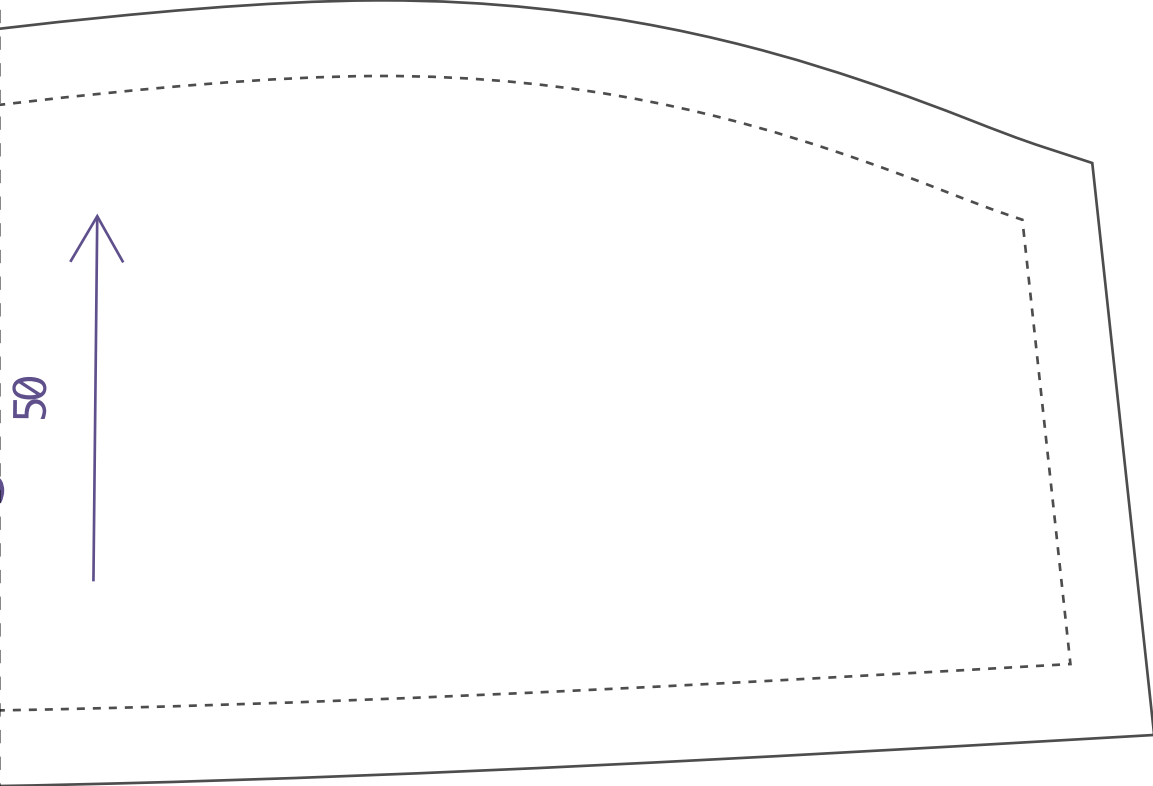

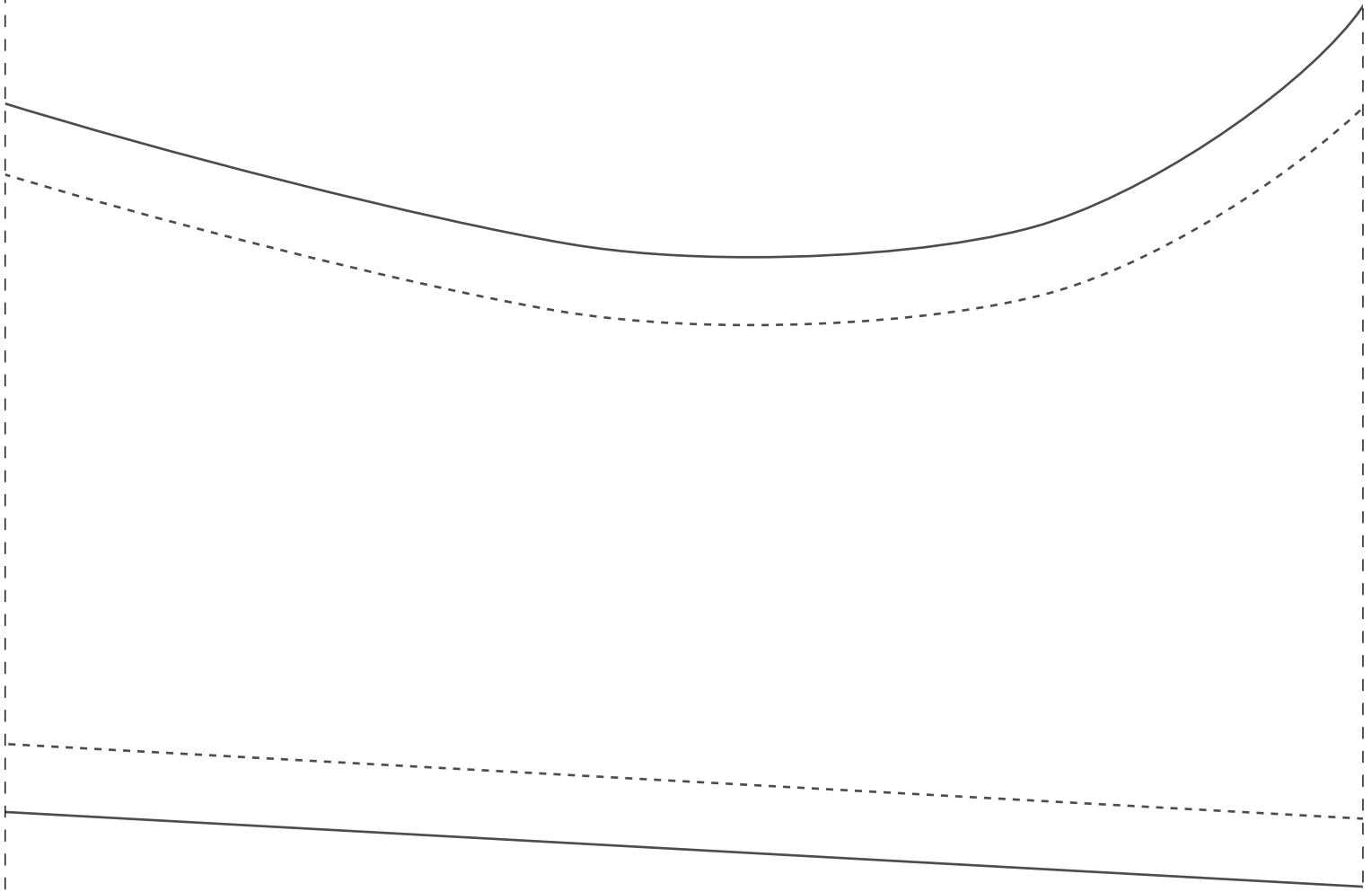

FICHA TÉCNICA:

TECIDO PLANO COM 1,4m DE LARGURA

-Linho, gabardine, alfaiataria
ou similares

-Limpeza da peça com forro

-1,9m para os tamanhos 36 ao 42

-2,3m para os tamanhos 44 ao 54

-Forro: 1m para todos os tamanhos

costas 2x
50

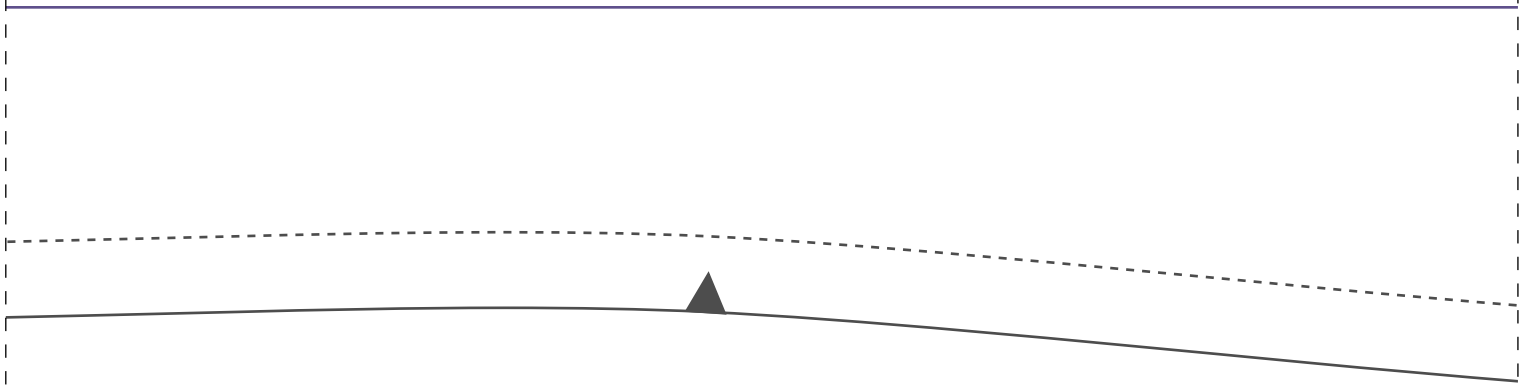

3-8

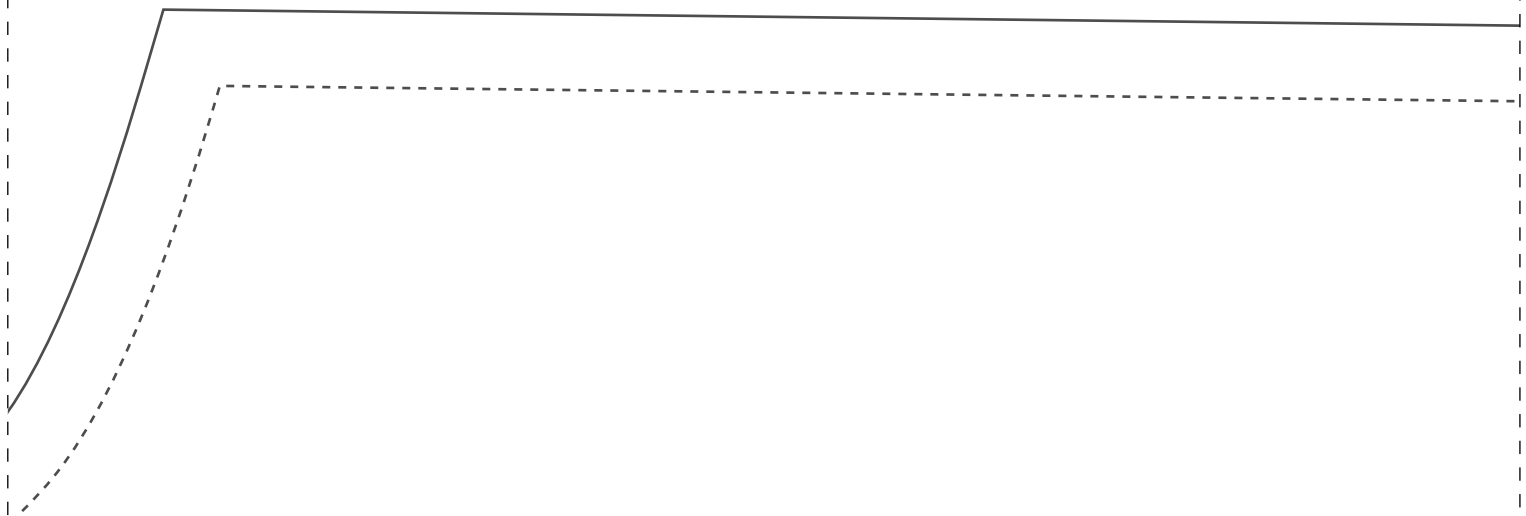

forro/fi
5

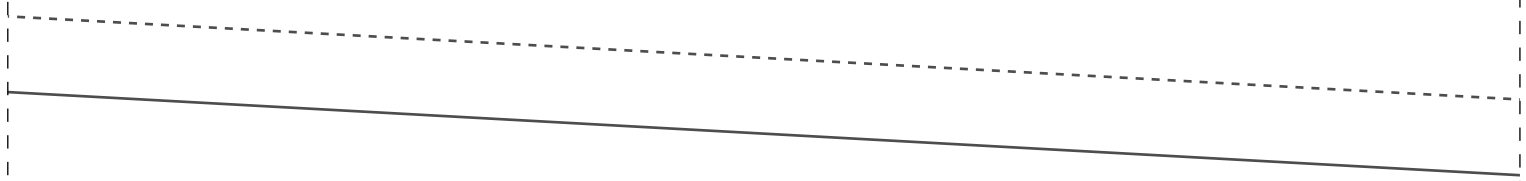

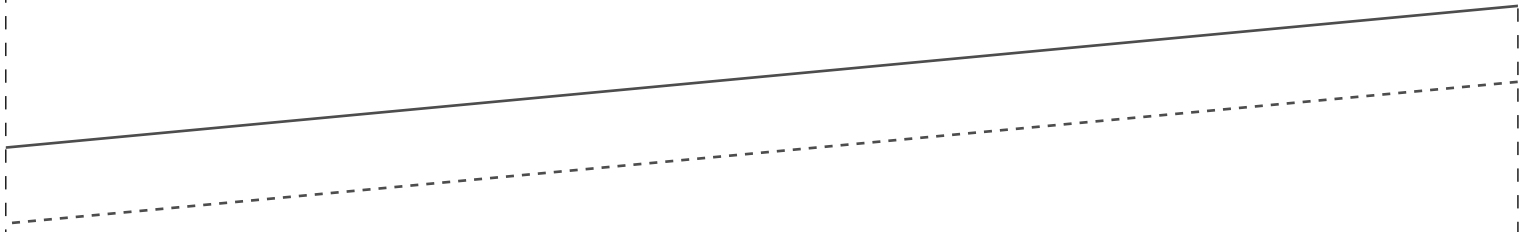

IDDED CD34



3-9



rente 2x
0

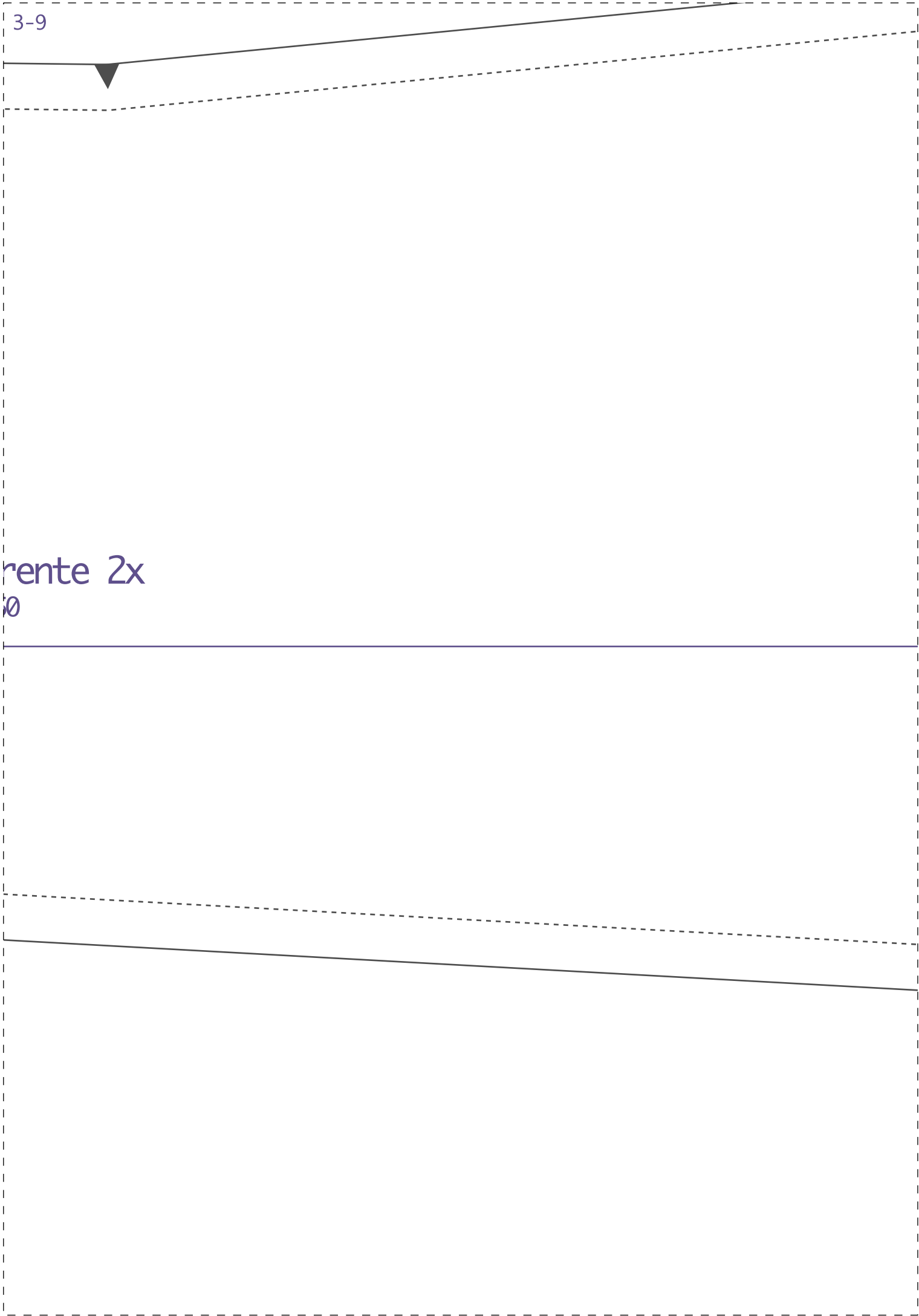

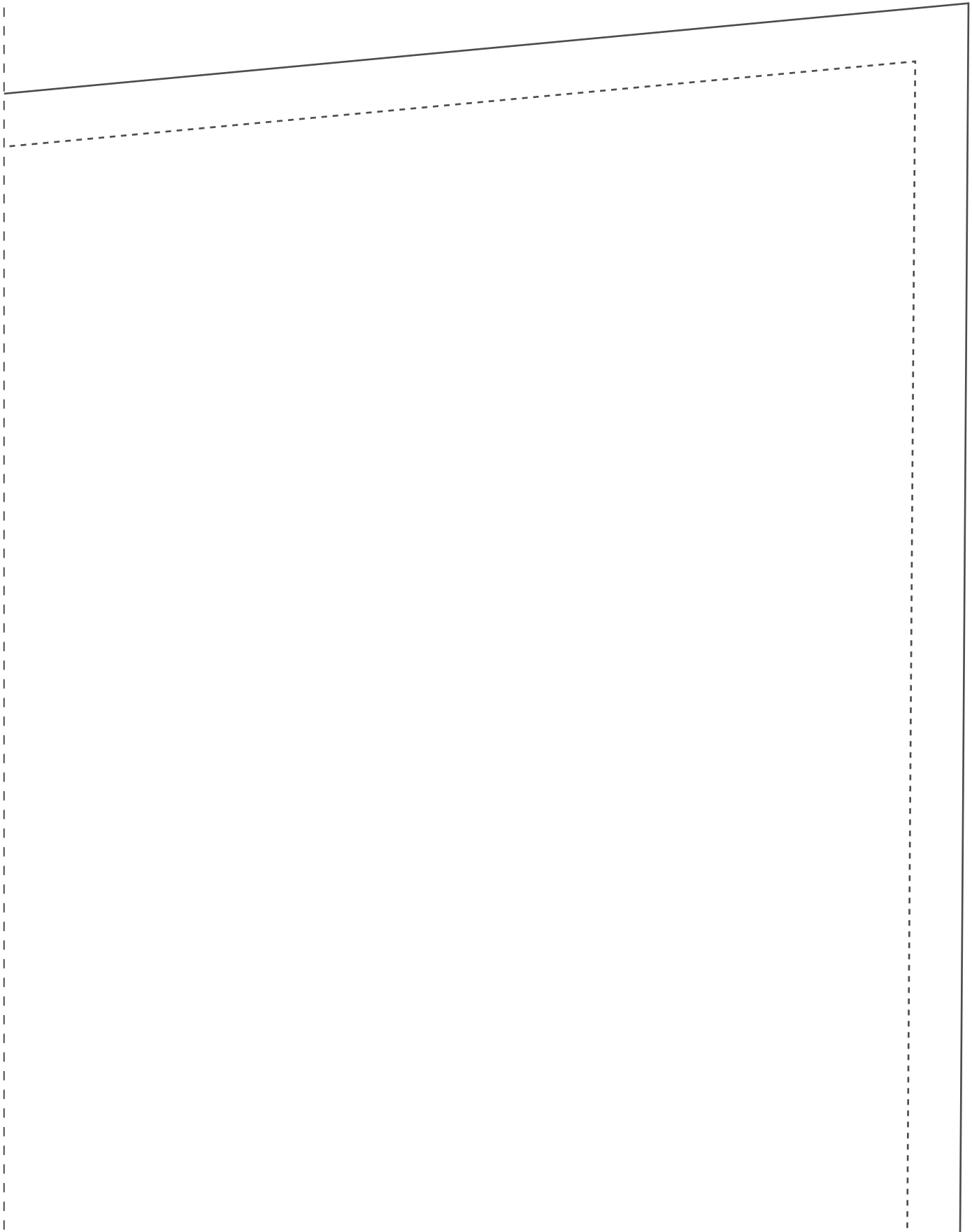

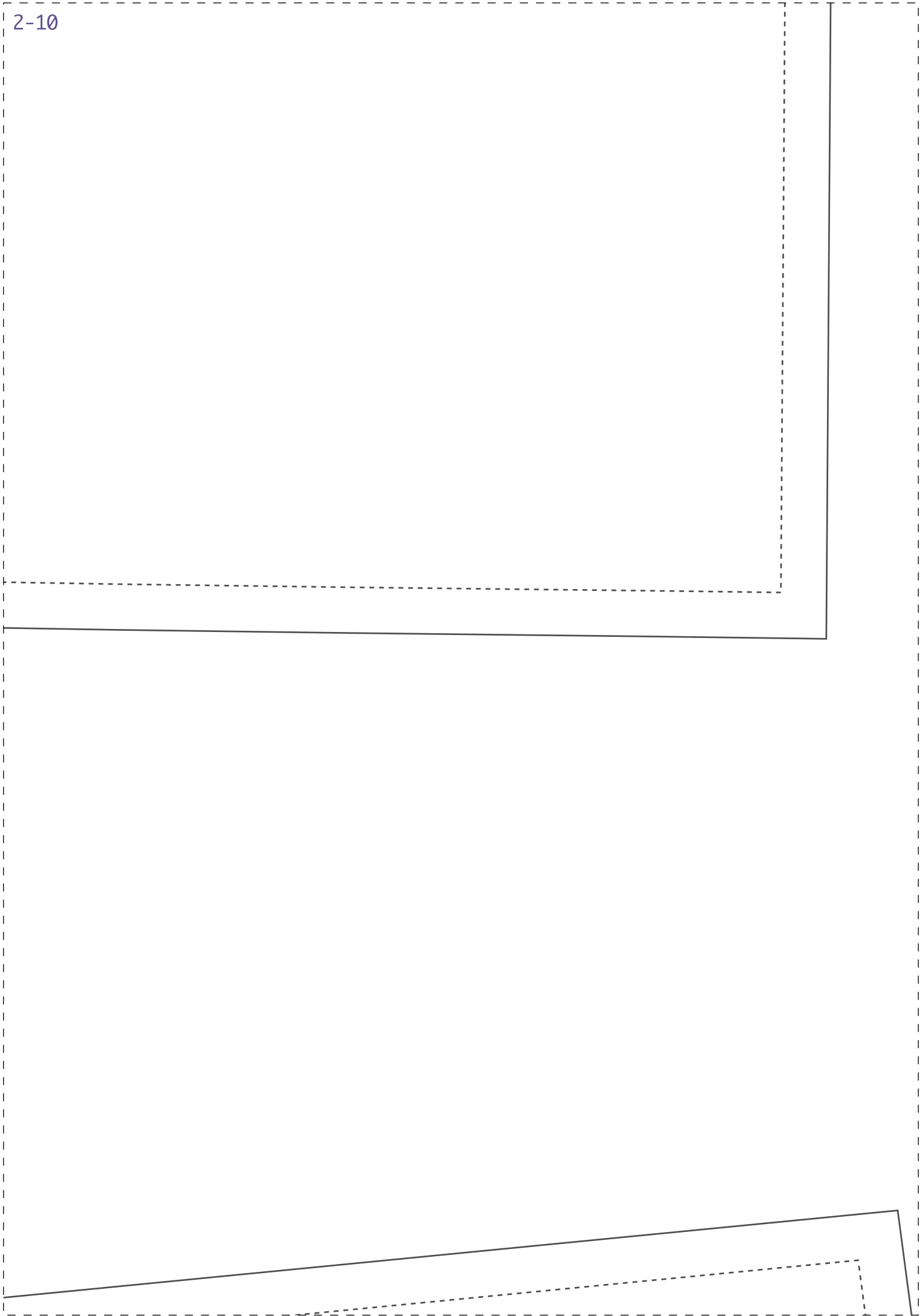

3-10



IDDED CD34

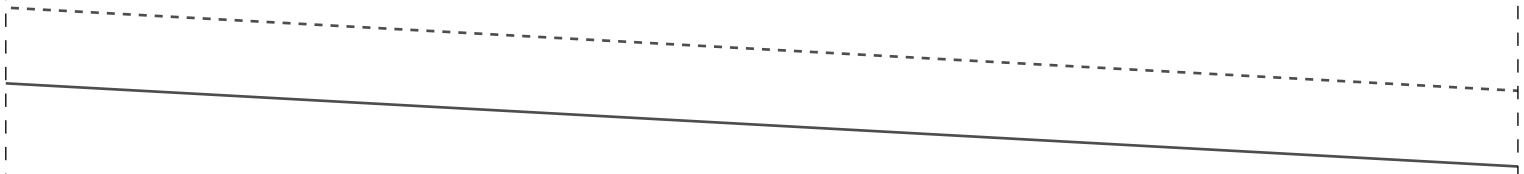

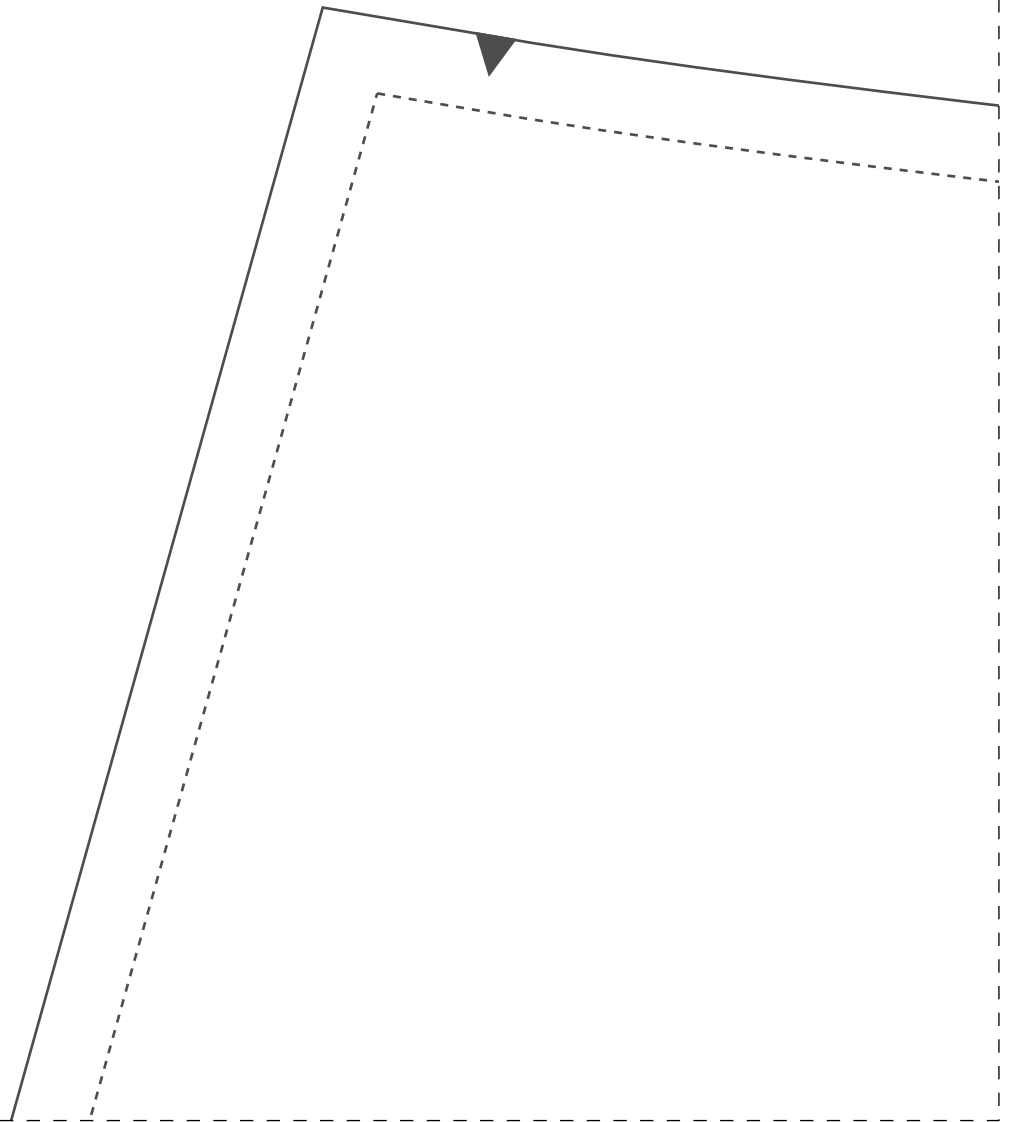

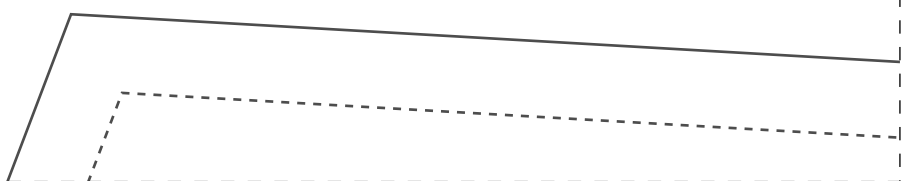
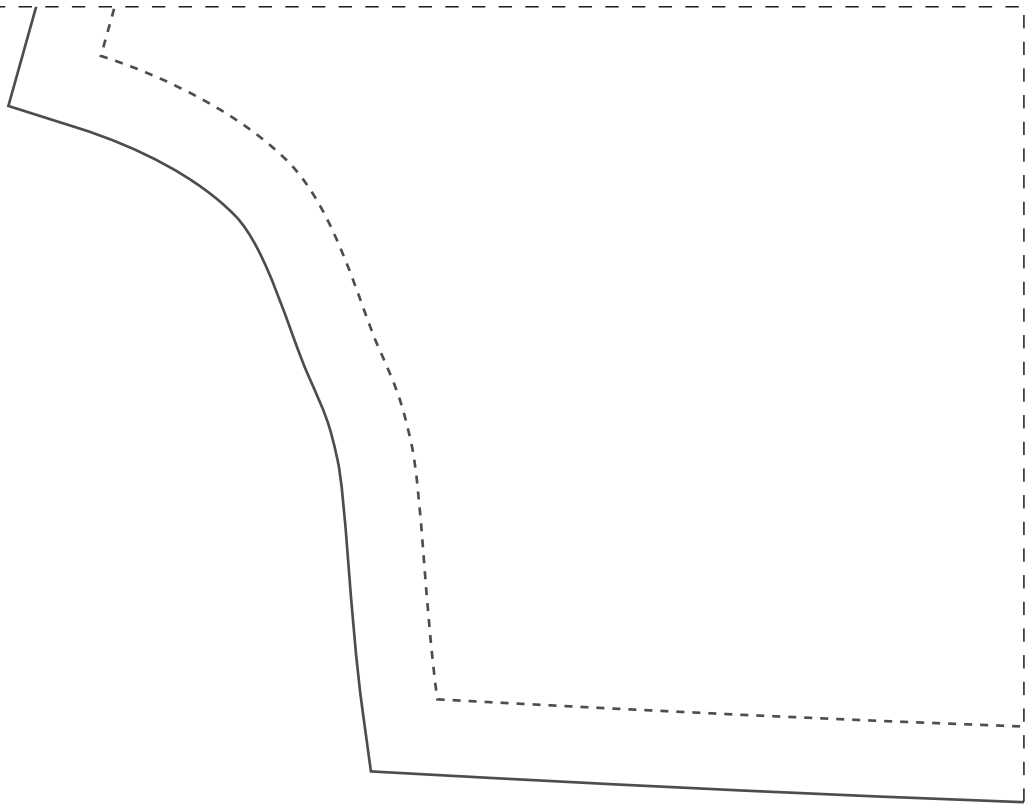

3-11

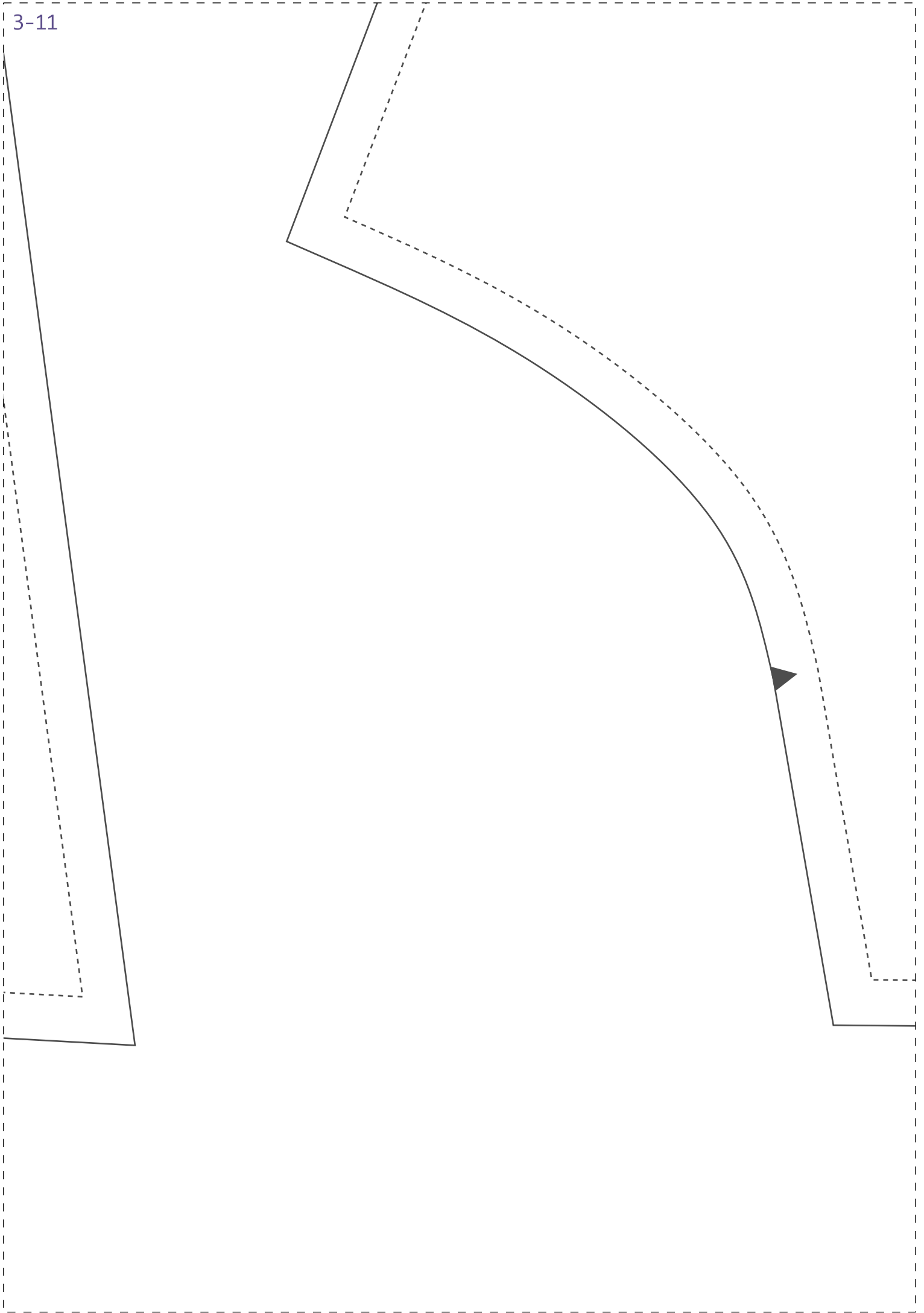

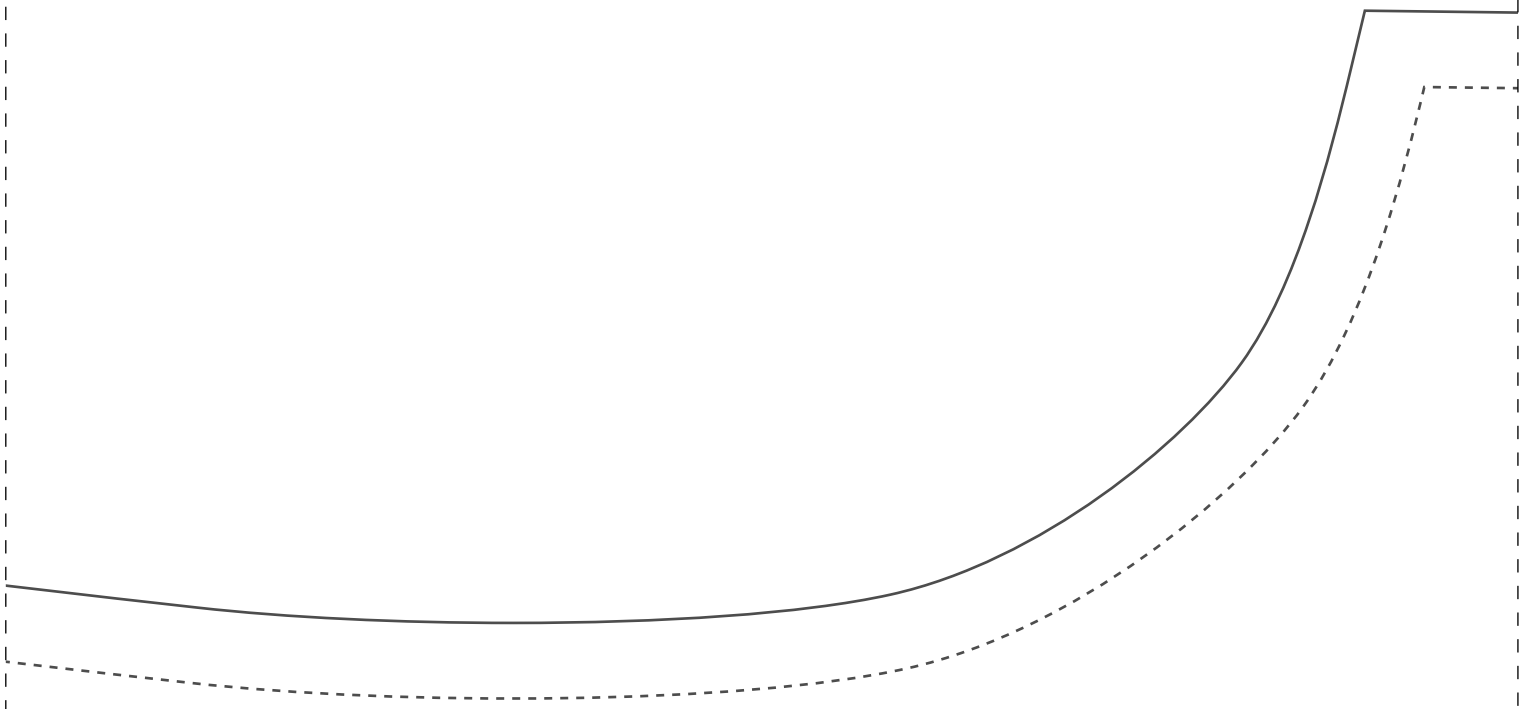





Instituto Diana Demarchi
Escola de Costurar
IDD Fashion Day
Colete Feminino Alfaiataria

PROIBIDA REVENDA

forro/costas 2x
50

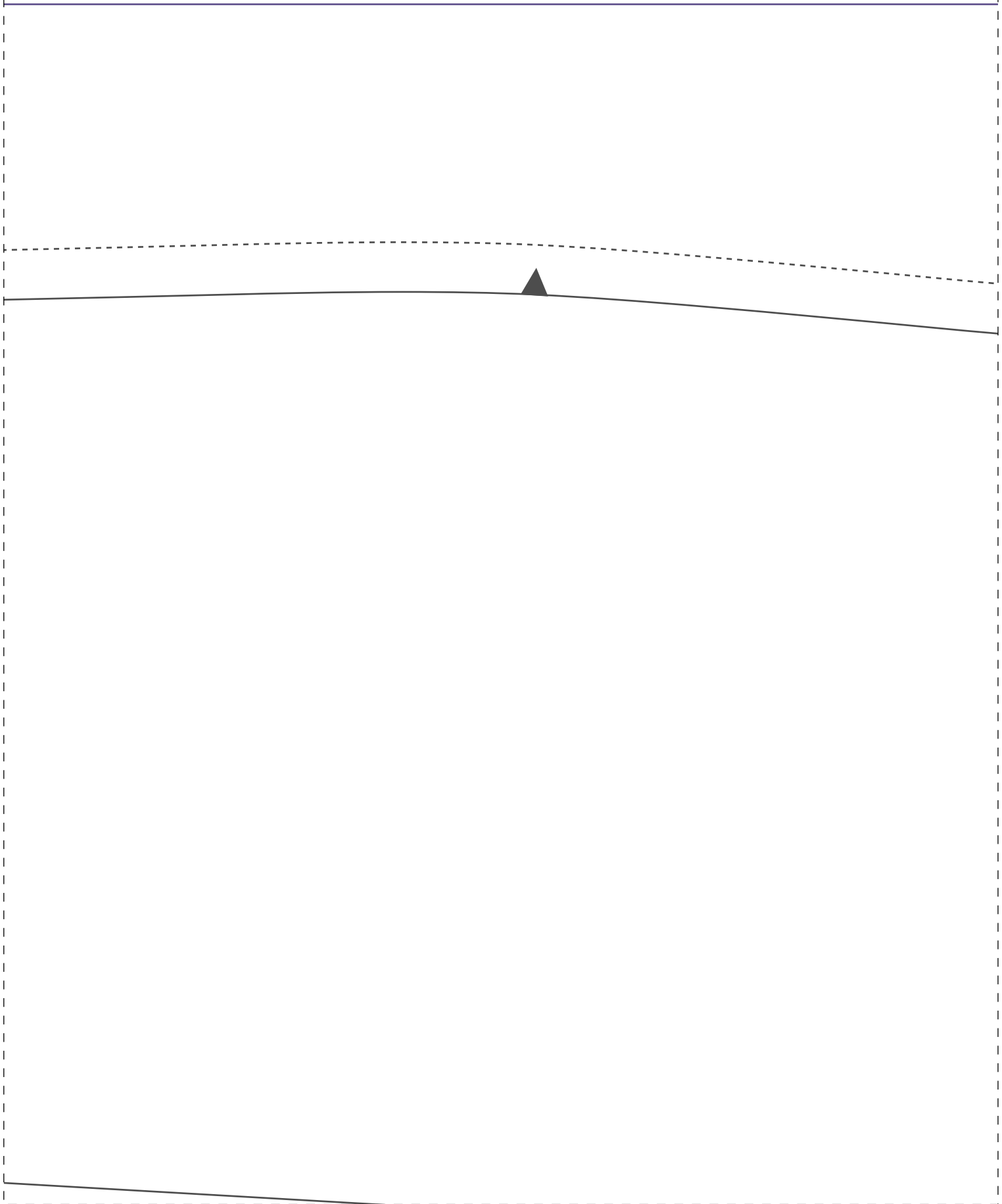

revel/frente 2x
50



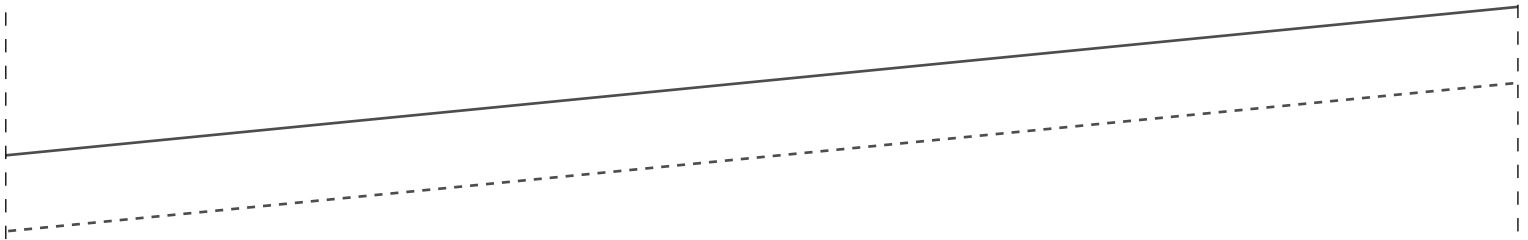

IDDED CD34

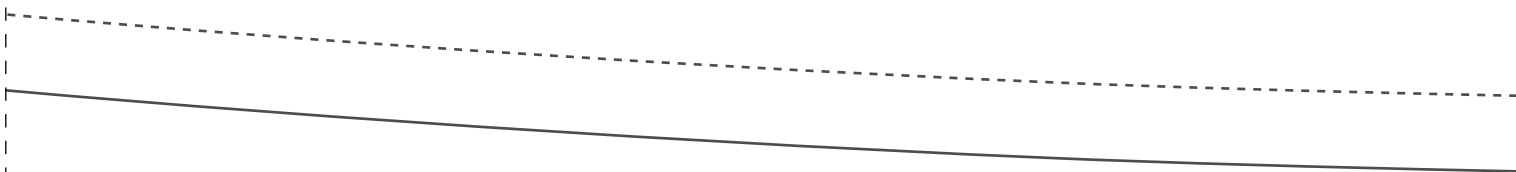

3-14

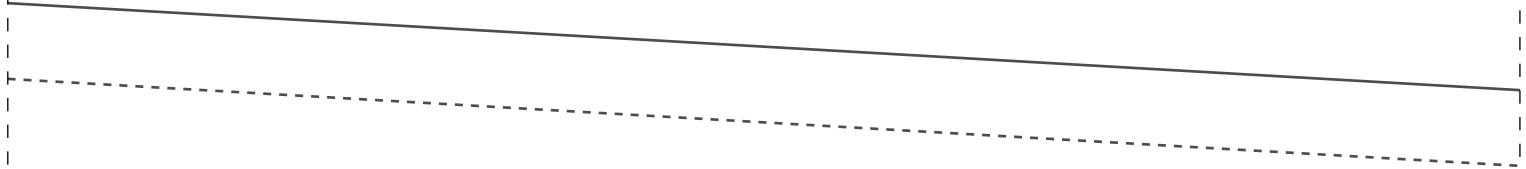

IDDED CD34



-

